

# General Mason

(Job Role)

Qualification Pack: Ref. Id. CON/Q0103

Sector: Construction

Textbook for Class XI



171103

विद्यया ऽ मृतमश्नुते



एन सी ई आर टी  
NCERT

राष्ट्रीय शैक्षिक अनुसंधान और प्रशिक्षण परिषद्  
NATIONAL COUNCIL OF EDUCATIONAL RESEARCH AND TRAINING

**ISBN 978-93-5292-346-5**

**First Edition**

*October 2020 Ashwina 1942*

**PD 5T SU**

**© National Council of Educational  
Research and Training, 2020**

**₹ 90.00**

*Printed on 80 GSM paper with NCERT  
watermark*

Published at the Publication Division  
by the Secretary, National Council of  
Educational Research and Training,  
Sri Aurobindo Marg, New Delhi 110 016  
and printed at Haploos Printing House,  
A-23, Mayapuri Industrial, Area,  
Phase-II, New Delhi 110 064.

**ALL RIGHTS RESERVED**

- ❑ No part of this publication may be reproduced, stored in a retrieval system or transmitted, in any form or by any means, electronic, mechanical, photocopying, recording or otherwise without the prior permission of the publisher.
- ❑ This book is sold subject to the condition that it shall not, by way of trade, be lent, re-sold, hired out or otherwise disposed off without the publisher's consent, in any form of binding or cover other than that in which it is published.
- ❑ The correct price of this publication is the price printed on this page. Any revised price indicated by a rubber stamp or by a sticker or by any other means is incorrect and should be unacceptable.

**OFFICES OF THE PUBLICATION**

**DIVISION, NCERT**

NCERT Campus  
Sri Aurobindo Marg  
New Delhi 110 016 **Phone : 011-26562708**

108, 100 Feet Road  
Hosdakere Halli Extension  
Banashankari III Stage  
Bengaluru 560 085 **Phone : 080-26725740**

Navjivan Trust Building  
P.O. Navjivan  
Ahmedabad 380 014 **Phone : 079-27541446**

CWC Campus  
Opp. Dhankal Bus Stop  
Panihati  
Kolkata 700 114 **Phone : 033-25530454**

CWC Complex  
Maligaon  
Guwahati 781 021 **Phone : 0361-2674869**

**Publication Team**

Head, Publication Division : *Anup Kumar Rajput*

Chief Editor : *Shveta Uppal*

Chief Production Officer : *Arun Chitkara*

Chief Business Manager (In-charge) : *Vipin Dewan*

Production Assistant : *Prakash Veer Singh*

**Cover and Layout**

*DTP Cell, Publication Division*

## FOREWORD

The National Curriculum Framework–2005 (NCF–2005) recommends bringing work and education into the domain of the curricular, infusing it in all areas of learning while giving it an identity of its own at relevant stages. It explains that work transforms knowledge into experience and generates important personal and social values such as self-reliance, creativity and cooperation. Through work one learns to find one’s place in the society. It is an educational activity with an inherent potential for inclusion. Therefore, an experience of involvement in productive work in an educational setting will make one appreciate the worth of social life and what is valued and appreciated in society. Work involves interaction with material or other people (mostly both), thus, creating a deeper comprehension and increased practical knowledge of natural substances and social relationships.

Through work and education, school knowledge can be easily linked to learners’ life outside the school. This also makes a departure from the legacy of bookish learning and bridges the gap between the school, home, community and workplace. The NCF–2005 also emphasises on Vocational Education and Training (VET) for all those children, who wish to acquire additional skills and/or seek livelihood through vocational education after either discontinuing or completing their school education. VET is expected to provide a ‘preferred and dignified’ choice rather than a terminal or ‘last-resort’ option.

As a follow-up of this, NCERT has attempted to infuse work across subject areas and also contributed in the development of the National Skill Qualification Framework (NSQF) for the country, which was notified on 27 December 2013. It is a quality assurance framework that organises all qualifications, according to levels of knowledge, skills and attitude. These levels, graded from one to ten, are defined in terms of learning outcomes, which the learner must possess regardless of whether they are obtained through formal, non-formal or informal learning. The NSQF sets common principles and guidelines for a nationally recognised qualification system covering schools, vocational education and training institutions, technical education institutions, colleges and universities.

It is under this backdrop that Pandit Sunderlal Sharma Central Institute of Vocational Education (PSSCIVE), Bhopal, a constituent of

NCERT, has developed learning outcomes based modular curricula for vocational subjects from Classes IX to XII. This has been developed under the Centrally Sponsored Scheme of Vocationalisation of Secondary and Higher Secondary Education of the Ministry of Education, erstwhile Ministry of Human Resource Development.

This textbook takes care of generic skills embedded in various job roles in a comprehensive manner and also provides more opportunities and scope for students to engage with these common and necessary skills, such as communication, critical thinking and decision making in different situations pertaining to different job roles.

I acknowledge the contribution of the development team, reviewers and all institutions and organisations, which have supported in the development of this textbook.

NCERT would welcome suggestions from students, teachers and parents, which would help us to further improve the quality of the material in subsequent editions.

New Delhi  
September 2020

HRUSHIKESH SENAPATY  
*Director*  
National Council of Educational  
Research and Training

## ABOUT THE TEXTBOOK

Construction sector in India is considered to be the second largest employer and contributor to economic activity, after agriculture sector. This sector employs more than 44.08 million people in the country. Around 50 per cent of the demand for construction activities in India comes from the infrastructure sector, while the rest comes from industrial activities, residential and commercial development, etc. The construction industry accounts for about 11 per cent of India's GDP. The Planning Commission estimates that the construction sector will require another 47 million people in the workforce over the next decade.

There is a need for formal training for construction workers. This book contains chapters for imparting knowledge and skills on various aspects of the construction technology. It also includes information, exercises and assessment activities.

This textbook has been developed with the contribution of subject experts, vocational teachers, industry experts and academicians for making it a useful and inspiring teaching-learning resource material for the vocational students. Adequate care has been taken to align the content of the textbook with the National Occupational Standards (NOS) for the job role so that the student acquires the necessary knowledge and skills as per performance criteria mentioned in the respective NOS of the Qualification Pack (QP). The NOS for the job role of 'General Mason' covered through this textbook are as follows:

1. CON/N0110: Construct masonry structures using brick and block
2. CON/N0111: Execute plaster on internal and external surfaces of masonry and RCC structure
3. CON/N0112: Carry out waterproofing works for structures using cementitious materials
4. CON/N0113: Build structures using random rubble masonry
5. CON/N0114: Carry out IPS and Tremix flooring
6. CON/N8001: Work effectively in a team to deliver desired results at the workplace
7. CON/N8002: Plan and organise work to meet expected outcomes

Unit 1 of the textbook gives introduction to stone masonry. Unit 2 focusses on brick masonry. Unit 3 deals with plastering work. Unit 4 is on precast block masonry. Unit 5 deals with the waterproofing work of different structures.

We extend our gratitude to all the contributors for selflessly sharing their precious knowledge, acclaimed expertise and valuable time and positively responding to our request for the development of this textbook.

SAURABH PRAKASH  
*Professor*  
Department of Engineering and Technology  
PSSCIVE, NCERT, Bhopal

© NCERT  
not to be republished

# TEXTBOOK DEVELOPMENT TEAM

## MEMBERS

Abhay Kumar Jha, *Head*, Civil Engineering Department, LNCTS, Bhopal

Aslam Nadaf, *Vocational Instructor–Construction*, Govt. High School, Pernem, Goa

Avinash Singh, *Consultant*, PSSCIVE Bhopal, Madhya Pradesh, India

Hemant Wadikar, *Lecturer*, Building Maintenance, Swami Vivekanand Jr. College (HSC Vocational) Sindhi Society, Chembur, Mumbai-400071, Maharashtra, India

Tapas Singh, *Assistant Professor*, Civil Engineering Department, TITE, Bhopal

## MEMBER-COORDINATOR

Saurabh Prakash, *Professor*, Engineering and Technology Department, Pandit Sunderlal Sharma Central Institute of Vocational Education, Bhopal-462013, Madhya Pradesh, India

## ACKNOWLEDGEMENTS

The National Council of Educational Research and Training (NCERT) expresses its gratitude to all members of the Project Approval Board (PAB) and officials of the Ministry of Education (MoE), Government of India, for their cooperation in the development of this textbook. The Council also extends gratitude to all the contributors for sharing their expertise and valuable time by positively responding to the request for the development of this textbook. The Council expresses its gratitude towards Rajesh Khambayat, *Joint Director*, PSSCIVE, Bhopal, for providing support and guidance in the development of this textbook. The contribution of our textbook review committee member, Gagan Gupta, *Professor*, NCERT, New Delhi, is also duly acknowledged. We are thankful to Saurabh Prakash, *Professor*, Department of Engineering and Technology, PSSCIVE, NCERT, Bhopal, for providing photographs used in the textbook. The images used other than these are under Creative Commons License. Avinash Singh, *Former Consultant*, Department of Engineering and Technology, PSSCIVE, Bhopal, is also duly acknowledged for his contribution in the development of this textbook for vocational skills. The Council is grateful to Saroj Yadav, *Professor and Dean (Academic)*, NCERT, and Ranjana Arora, *Professor and Head*, Department of Curriculum Studies, for evaluating and giving suggestions for the improvement of this book and its finalisation.

The Council acknowledges the copyediting by Blue Fish Designs Pvt. Ltd. Chanchal Chauhan, *Proofreader* (Contractual), is also acknowledged for proofreading this book. The efforts of Pawan Kumar Barriar, *DTP Operator*, and Hari Darshan Lodhi, *DTP Operator* (Contractual), Publication Division, NCERT; Akhilesh Kashiv, *Computer Operator*, Vikas Kumar Koge, *Graphic Artist* (Contractual), and Pinki Tiwari, *Graphic Designer* (Contractual), PSSCIVE, NCERT, for flawless layout design are also acknowledged. The Council is also grateful to the Construction Skill Development Council of India (CSDC), New Delhi, for its support.



# CONTENTS

<i>Foreword</i>	<i>iii</i>
<i>About the Textbook</i>	<i>v</i>
Unit 1: Stone Masonry	1
Unit 2: Brick Masonry	18
Unit 3: Plastering Work	32
Unit 4: Precast Block Masonry	43
Unit 5: Waterproofing Works for Structures using Cementitious Materials	60
<i>Answer Key</i>	88
<i>Glossary</i>	89

**We  
can** *end all violence against women*

Equal Relationships  
are Violence Free



बराबरी  
के रिश्ते  
हिंसा से  
मुक्त



[www.wecanend.org](http://www.wecanend.org)



# Stone Masonry

## INTRODUCTION

Stone is an economical material used in the construction of buildings and various building parts. In some parts of our country, stones are abundantly available in nature. These are cut and given different shapes as per the need.



171103CH01

## CATEGORIES OF STONE

Stones are categorised depending on their use in the construction of building structures and location. The categories of stone have been discussed as follows.

Selection of stones for masonry depends on the availability, ease of working, appearance, strength and stability, polishing characteristics, economy and durability.

**Table 1.1: Stones used for different purposes**

S.No.	Purpose	Stone used
1.	Heavy engineering work, e.g., docks, breakwaters, lighthouses, bridge piers	Granite and gneiss
2.	Buildings situated in industrial towns	Granite and compact sandstones

3.	Pavements railway ballast, door sills and steps	Granite and ballast
4.	Fire resistance works	Compact sandstone
5.	Carving and ornamental works	Marble and laterite
6.	Facelift and architectural purposes	Marble, granite and closer grained sandstone

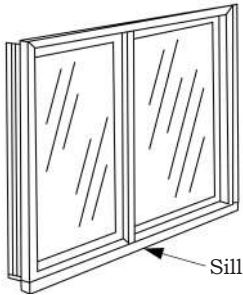

Fig. 1.1: Sill

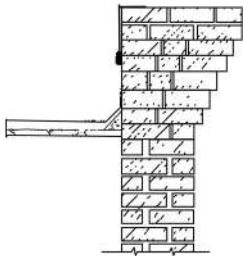

Fig. 1.2: Corbel

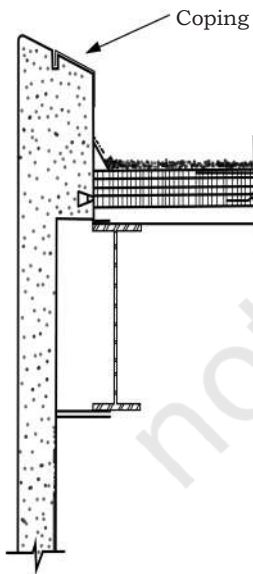
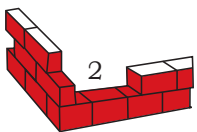

Fig. 1.3: Coping



### Sill

It is the bottom surface of a door or window opening (Fig. 1.1). Sill stones are dressed in a way that they prevent the entry of water into the building.

### Corbel

It is a projecting stone, which is used to provide support to roof truss, beam and weather sheds, etc. (Fig. 1.2). Corbels are, generally, moulded and given ornamental treatment. The corbels should extend at least two-third of their length into a wall.

### Cornice

It is a decorative border around the top of walls in a room or on the outside walls of a building. In other words, it is the uppermost horizontal area that appears like moldings along the top of a wall or just below a roof line. Stone is used to make cornice. Cornice overhang is used to protect the building's walls. It is, usually, painted to make it waterproof and weather resistant.

### Coping

To protect the walls of a building from rainwater, a course of stones are laid at the top of the wall or parapet wall. It is known as 'coping'. These stones are weathered and threaded for better resistance and durability (Fig.1.3).

### String Course

When a horizontal projected course of masonry is provided between the plinth and cornice, it is called

‘string course’. The purpose of string course is to provide architectural features, as well as, to check rainwater impact in buildings.

### Through Stone

It refers to a stone that is set with its longest dimension perpendicular to the face of a wall and the length of which is equal to the thickness of the wall (Fig.1.5). Such stones are known as through stones. The through stone should be strong and of sufficient thickness so as to avoid the danger of fracture due to any slight settlement of the wall.

### CLASSIFICATION OF STONE MASONRY

Based on the arrangement of stones in construction and degree of refinement in the surface finish, stone masonry can be classified into rubble and ashlar masonry.

### Rubble Masonry

In rubble masonry (also called rubble-work), stones of irregular sizes are used in construction of walls. The stones, as obtained from quarry are broken with the help of a hammer. The strength of rubble masonry depends on these factors.

- Quality of mortar
- Use of long through stones at frequent intervals
- Proper filling of mortar in space between stones

### Classification of rubble masonry

Rubble masonry is classified into the following categories:

- (a) Coursed rubble
- (b) Uncoursed rubble
- (c) Random rubble
- (d) Dry rubble
- (e) Polygonal rubble
- (f) Flint rubble

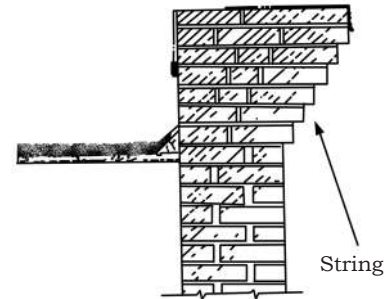
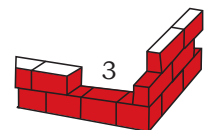

Fig. 1.4: String course



Fig. 1.5: Through stone



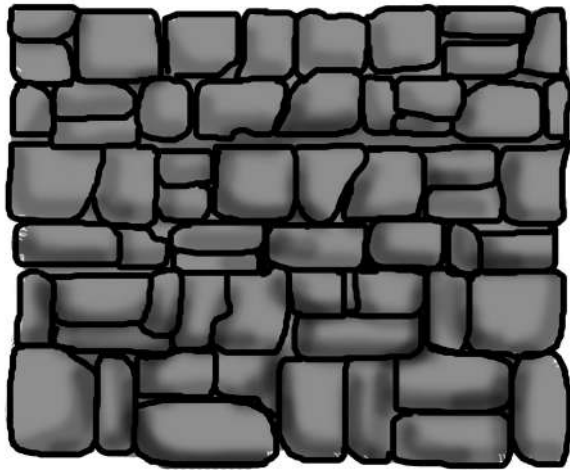

Fig. 1.6: Coursed rubble masonry

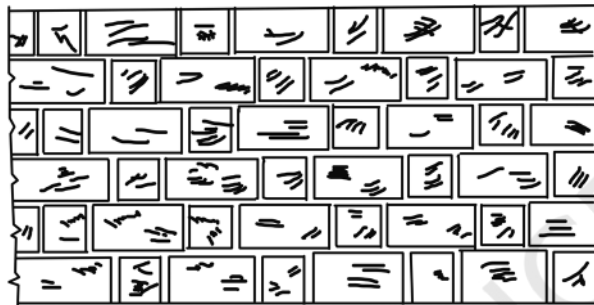

Fig. 1.7: Coursed rubble masonry—Class I

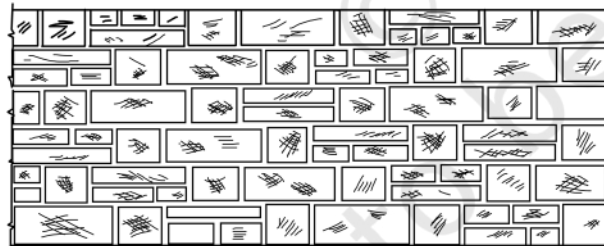

Fig. 1.8: Coursed rubble masonry—Class II

### **Coursed rubble**

This type of masonry is commonly used in the construction of low height walls of public and residential buildings, abutment and piers of ordinary bridges. In this type of masonry, the height of stones varies from 5 to 200 mm. The masonry work carried out in this course is such that the height of stones in a particular course should be the same. Coursed rubble masonry is further divided into three categories.

#### *Coursed rubble masonry—Class I*

In this type, stones of the same height are used and the courses are also of the same heights (Fig.1.7).

#### *Coursed rubble masonry—Class II*

This type is similar to Class I, except that:

- the stones to be used are of different heights.
- the courses need not to be of equal heights.
- only two stones are to be used to make up the height of one course.
- the thickness of mortar joint is 12 mm.

#### *Coursed rubble masonry—Class III*

This type is similar to Class I, except that:

- the stones to be used are of different heights, the minimum being 50 mm.
- the courses need not be of equal heights.
- only three stones are to be used to make up the height of one course.
- the thickness of the mortar joint is 16 mm.

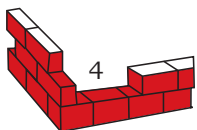

### **Uncoursed rubble masonry**

When stones from quarry are used without any dressing, except knocking out some coarseness, then it is known as uncoursed rubble masonry. The courses are not uniformed and no maintenance is required. In this masonry, larger stones are fixed in bottom and spaces between these stones are filled up by means of small stones known as spall (Fig. 1.9). The height of wall made with this masonry can vary from 30 cm to 50 cm. This rubble masonry is used for construction of compound walls, garages, godowns, etc. Cost of this masonry is the cheapest.

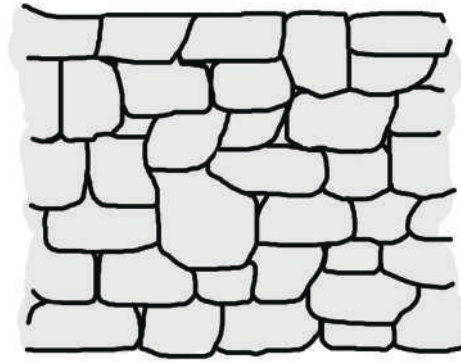

Fig. 1.9: Uncoursed rubble masonry

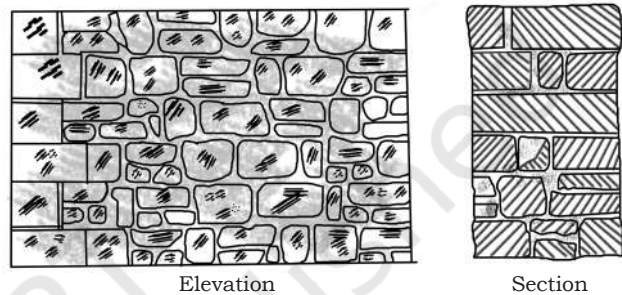

Fig. 1.10: Random rubble masonry

### **Random rubble masonry**

This type of masonry consists of stones of irregular sizes and shapes. The stones are arranged in such a pattern that gives good appearances. It is a specialised job and requires skilled personnel to make the structure stable.

Uncoursed random rubble masonry is made by stacking stones of different sizes and qualities. Weak corners and edges of the stone are removed by hammer.



Fig. 1.11: Uncoursed random rubble masonry

### **Dry rubble masonry**

In this masonry, no mortar is used in joints. It is similar in construction to coursed rubble masonry. This type of construction is the cheapest but it requires more skill in construction. It is preferred for compound walls pitching on bridge approaches, retaining walls,



Fig. 1.12: Dry Rubble Masonry

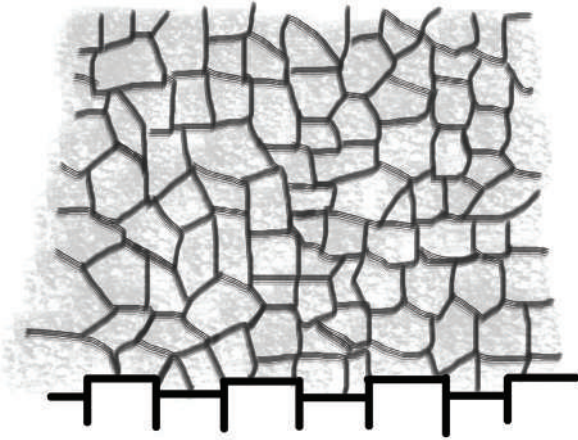

Fig. 1.13: Polygonal rubble masonry

etc. To avoid displacement of stones, two courses at the top and about 50 cm length at the ends may be built in mortar.

### **Polygonal rubble masonry**

It is a technique of stone wall construction. In this masonry, visible surfaces of the stones are dressed in such a way that the block appearance looks like a polygon. It is a special technique of masonry. More skill is required in the construction of this type of masonry.

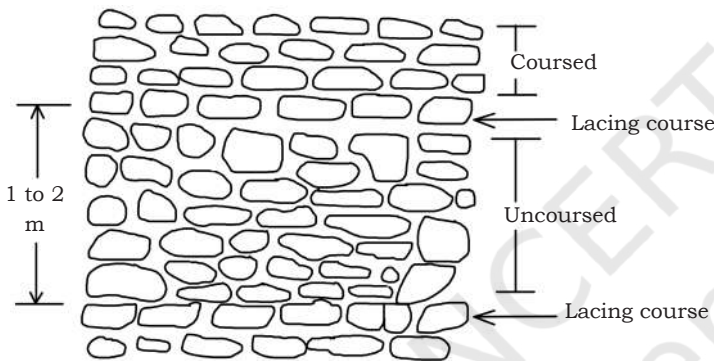

Fig. 1.14: Flint rubble masonry

### **Flint rubble masonry**

In this type of masonry, the stones used are called flints. The flint stones varying in thickness from 8 to 15 cm and in length from 15 to 30 cm, are arranged in the form of coursed or uncoursed masonry. In the case of buildings in coastal areas, the rounded flints procured from beaches are used. The joints of flint rubble masonry are slightly raked back with a pointed stick to improve the appearance.

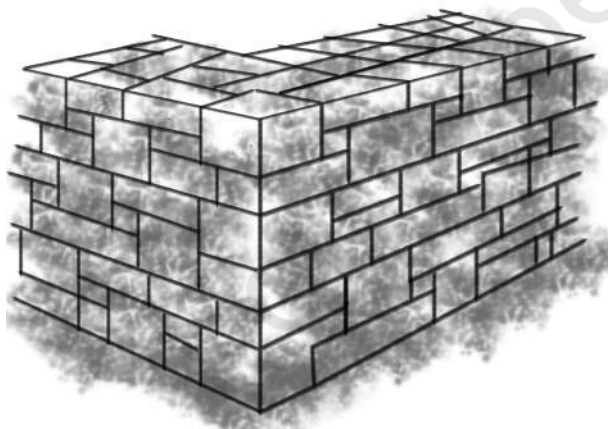
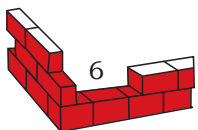

Fig. 1.15: Ashlar Masonry

### **Ashlar Masonry**

This is considered to be a superior quality of masonry. This is built from accurately dressed stones with uniform and very fine joints. The various types of ashlar masonry can be classified as:

- (a) Ashlar fine
- (b) Ashlar rough tooled





- (c) Ashlar rock or quarry faced
- (d) Ashlar chamfered
- (e) Ashlar facing
- (f) Ashlar block in course

### Ashlar fine

At all beds joints and faces stones should be dressed perfectly so that they confirm to the desired pattern (Fig. 1.16). The stones are arranged in proper bond and the thickness of the mortar joint does not exceed 3 mm. This gives perfectly smooth appearance but it is costly in construction.

### Ashlar rough tooled

The size of stones bond, etc., have similar specification as described in case of ashlar fine masonry. The exposed face of this masonry should be given a fine dressed, chisel drafting of about 25 mm in width. The thickness of mortar joint does not exceed 6 mm.

### Ashlar rock or quarry faced

In this type of masonry, the exposed faces of the facing stones between the chisel drafting all around are left undressed. However, the projections of size more than 8 cm are broken. All other specifications are kept similar to that of ashlar rough tooled masonry. This type of construction gives massive appearance.

### Ashlar chamfered

The specifications regarding size bonds and the type of joints are similar to the one as described above. The exposed edge of stones are levelled for a depth of about 2.5 cm (Fig.1.19).

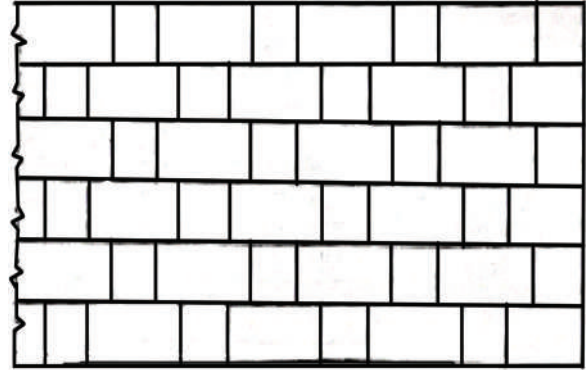

Fig. 1.16: Ashlar Fine



Fig. 1.17: Ashlar rough tooled masonry



Fig. 1.18: Ashlar rock or quarry faced

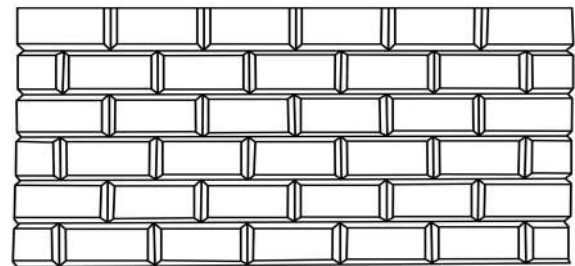

Fig. 1.19: Ashlar Chamfered

## Ashlar facing

In this type of construction the facing is constructed in ashlar masonry and the backing may be on the brick masonry, rubble masonry or concrete masonry. This arrangement of masonry leads to saving of material and money. The height of course should be more than 200 mm. The facing stones are either rough tooled or chamfered.

## Ashlar block in course

This type of masonry occupies an intermediate position between rubble masonry and the ashlar masonry. The faces of the stones are generally hammer dressed and thickness of mortar joint does not exceed 6 mm. This type of construction is used for heavy engineering works such as retaining wall, sea wall, etc.

## JOINTS IN STONE MASONRY

The joints in stone masonry can be broadly categorised in the following types.

- (1) Butt or squared joint
- (2) Rebated or lapped joint
- (3) Tongued and grooved joint
- (4) Tabled joint
- (5) Saddled joint
- (6) Rusticated joint
- (7) Plugged joint
- (8) Dowelled joint
- (9) Cramped joint
- (10) Flushed joint



Fig. 1.20: Butt joint

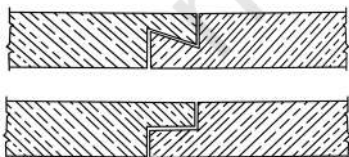

Fig. 1.21: Rebated joint

### (1) Butt or Squared Joint

This is a common joint and is extensively used for usual tasks. Square surface of one stone is placed against that of another stone in this joint. (Fig. 1.20)

### (2) Rebated or Lapped Joint

Rebates are used in these joints. These rebates prevent the movement of stones. The length of rebate varies

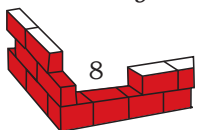

as per the requirement, but it should not be less than 70mm.

### (3) Tongued and Grooved Joint

In this joint, a projection of one stone gets fitted in the adjoining stone. Both stones get joined with the depression or groove. This arrangement reduces the sliding of one stone over the other. This is also known as joggle joint.

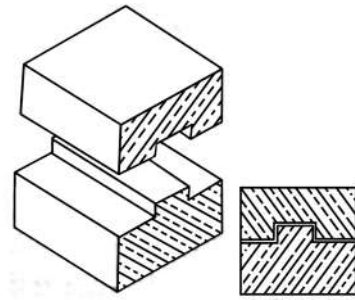

Fig. 1.22: Bed joint or tabled joint

### (4) Tabled Joint

To check the lateral movement of water through the bed of the stone, a joggle joint is used. This joint is mostly used where lateral pressure is heavy, like the structure of sea walls.

### (5) Saddled Joint

To protect the joints or cornices from rain water, the stone is rounded off, it is known as saddled joint. It diverts the water moving on the weathered surface from the joints.

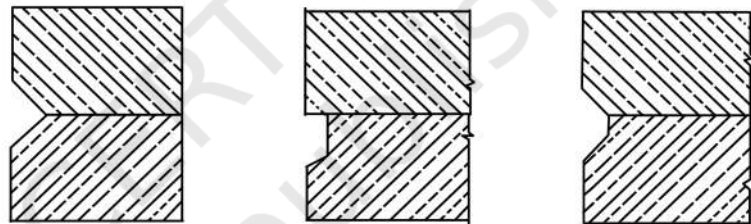

Vee Joint

Channeled Joint

### (6) Rusticated Joint

In this type of joint the edges of the joints are sunk below the plane of face work. The different types of rusticated joints can be—channeled joint, vee joint, and vee and channeled joint.

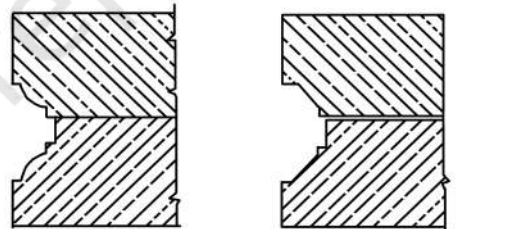

Moulded Joint

Vee and Channeled Joint

Fig. 1.23: Rusticated or rebated joint

### (7) Plugged Joint

It can also be used in place of cramped joints. In this joint, dovetail shaped mortises are kept in the sides of adjacent stones. They are sealed by pouring molten lead in the joint. The stones get connected firmly when molten lead becomes cool.

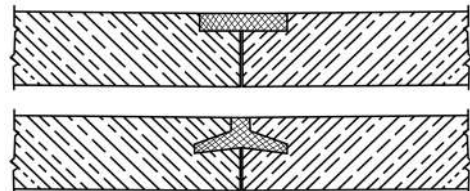

Fig. 1.24: Different forms of plug joints

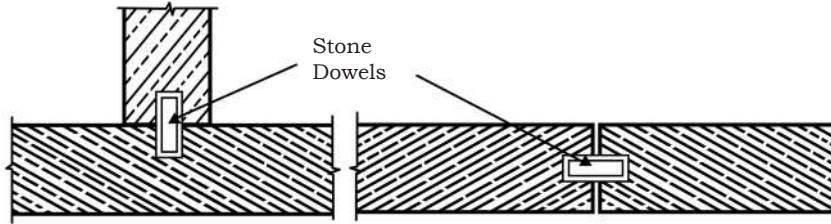

Fig. 1.25: Dowel Joint

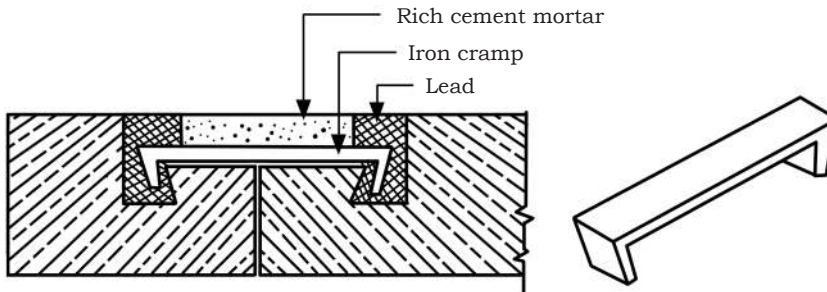

Fig. 1.26: Cramp joint

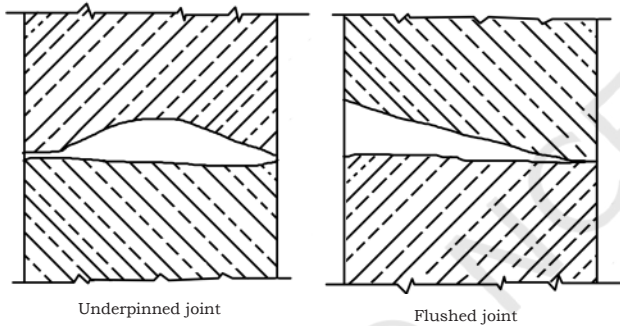

Fig. 1.27: Underpinned and Flushed joint

### (8) Dowelled Joint

In this type of joint, a hole is made into every stone in which small pieces of hard stone, slate, gun-metal brass, etc., are inserted and then sealed with cement.

### (9) Cramped Joint

When two stones are joined with the help of metal cramps, then this joint is known as cramped joint. This joint checks the stones to get away from each other.

Cramps are made up of non-corrosive metals. Cramps are inserted in stone 40–50 mm. The length, width and thickness of the cramps vary from 20 to 30 cm, 25 to 50 mm and 5 to 10 mm, respectively.

### (10) Flushed Joint

It is used in brick wall construction, when the surface requires plastering and final finishing. Thus the flushed joint will be hidden. Construction of flushed joints takes more time and work to make it watertight and water resistant.

## MAINTENANCE OF STONE MASONRY CONSTRUCTION

Stone masonry construction should be maintained with respect to the following:

- (1) Stains
- (2) Efflorescence
- (3) Cracks
- (4) Waterproofing

## Stains

The stains on stone work can be iron stains, copper stains, smoke and fix stains, oil stains, tobacco stains and ink stains.

Iron stains can be removed by washing the stained area with the solution of oxalic acid mixed in water (1 kg of oxalic acid mixed with 10 litres of water). The stained area is rubbed with brush and water after three to four hours. In order to remove dark and deep stains, a solution having one part of sodium citrate mixed with six parts of water is sprinkled. This surface is then covered with a thin layer of sodium hydrosulphide. The surface is washed after an hour.

Copper and bronze stains are removed by application of ammonium chloride solution (one part of ammonium chloride, four parts of powdered talc) with ammonia water.

Smoke and fix stains are treated with powdered pumice or grit. The surface is rubbed several times and cleaned.

Oil stains are treated with benzene or petrol. In order to remove deep oil stains, a mixture of acetone and amyl acetal is used. A dilute solution of trisodium phosphate can be used to remove the tobacco stains.

Chlorinated lime, ammonia water or concentrated solution of sodium perborate can be used to remove the ink stains.

## Efflorescence

The stones to be used for masonry work should be kept saturated with water so that they may not get discoloured because of acid action. Efflorescence is common with certain types of stones and can be prevented by having proper drainage in the building.

## Cracks

There can be small as well as large stone masonry cracks. Small cracks can be cleaned with wire brush and filled with thick paste of cement mix.

Large cracks can be raked out to get a firm key for the mortar. For this an inverted groove of at least 10 mm depth is required. A cement sand mortar of 1:2 ratio with less water is applied within an hour after mixing. Aluminium may also be added in the mixture to make it a tight fit.

### **Waterproofing**

Application of waterproofing material makes the stone masonry free from efflorescence, dampness, frost action, etc. Generally heavy petroleum distillate, fatty oil or insoluble soap serve as excellent waterproofing matter. These materials are applied as a washing coat; they may cause some temporary discolouration.

## **LAYING OF STONE MASONRY**

### **Points to be considered during construction**

- The stone should be hard, tough and durable.
- The stones should be well watered before use.
- There should not be any hollow space inside the wall.
- Through stones (headers) should be used in successive layers, at 1 m (3' to 5') to 1.5 m apart, both ways.
- Use artificial header (R.C.C.) in case of more width.
- Care should be taken to secure a good mortar bond throughout the masonry (approximately 20mm i.e.  $\frac{3}{4}$ " ). Corner stones are prepared from the mason's hammer.
- The joints should not be too smooth, to prevent the stones from sliding down.
- The wall should be truly vertical.
- Minimum 12mm ( $\frac{1}{2}$ " ) margin should be provided in column external face and masonry, to avoid the offset of rubble in plinth masonry after the plaster.

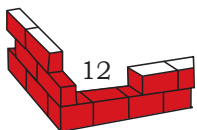

- Old work should be cleaned and watered before starting any new work on it.
- Keep expansion joint at 15m interval, in case of a compound wall.
- Lay some vertical stones in masonry for better bonding of the first and second day's work or layer of rubble masonry.
- The curing for masonry should be done for minimum two weeks.
- The through stone should be of a length which is at least thrice the depth.
- The joints should be pointed after proper curing and racking for at least 25mm (1") depth.

### **Mortar and Other Bonding Material Used for Masonry**

Mortar is a mixture of sand, water, lime and cement used in building construction for holding stones and bricks together. Mortar is placed in the joints. The selection of mortar depends on the load on structure, strength required, resistance desired for weathering agencies, etc. Mortar is classified as per its usage. Its different types are lime mortar, cement mortar, cement lime mortar and lime cement mortar.

When a portion of cement is replaced by hydrated lime, it is called 'cement lime mortar'. This mortar spreads more easily and faster. Spread with the help of a trowel, it acts as a smooth material like plastic. In 'lime cement mortar', a part of lime is removed and replaced by cement. It makes the mortar stronger, workable and more smooth. This type of mortar gets settled easily and faster.

- Masonry in cement mortar
- Masonry in lime mortar
- Masonry in mud mortar

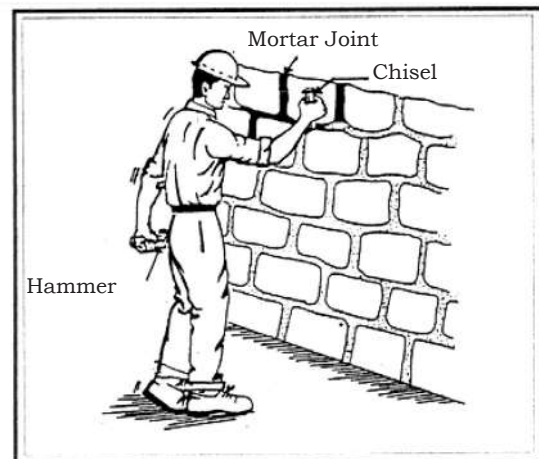
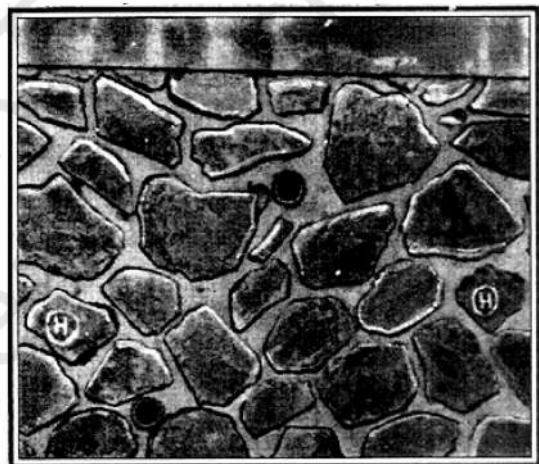

Fig.1.28: Dressing the stone with tools

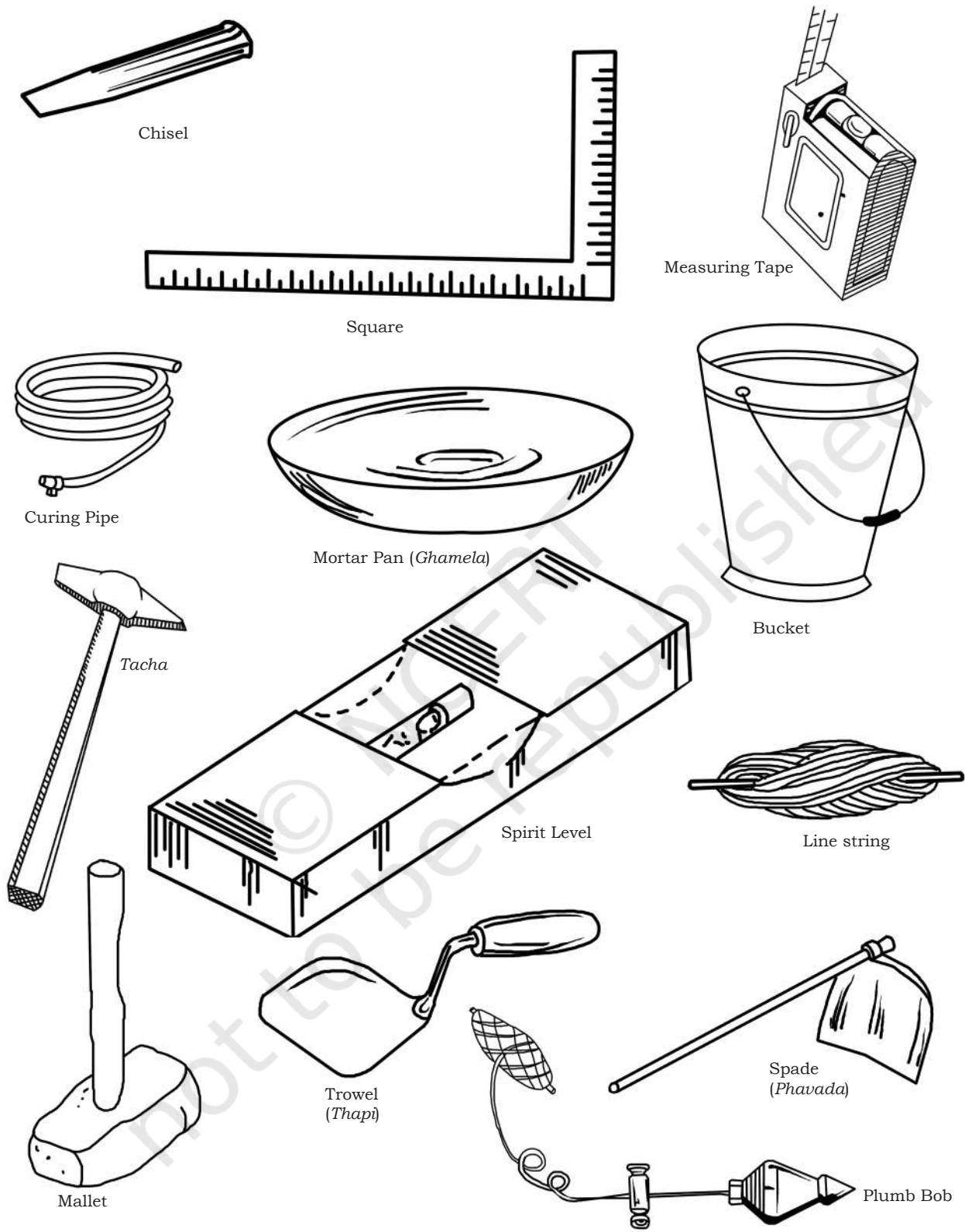

Fig. 1.29: Tools used in stone masonry



## Thickness of Masonry

- 10 cm thick
- 20 cm thick
- 30 cm thick
- 40 cm thick
- 50 cm thick
- 60 cm thick

## Proportion of Mortar

- Masonry in cement or lime mortar 1:8
- Masonry in cement or lime mortar 1:6
- Masonry in cement or lime mortar 1:4
- Masonry in cement or lime mortar 1:2
- 1:8, 1:6, etc., is the volumetric proportion where 1 stands for cement or lime and 8, 6 stand for sand.

### Practical Activity

1. Students may do the practice of dressing the stone with appropriate tools.
2. Students are requested to construct coursed rubble masonry as per the drawing given below.

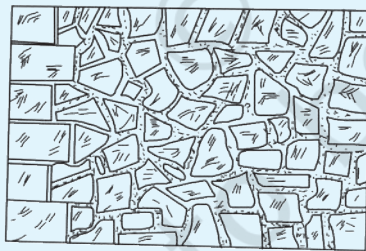

Elevation



Section

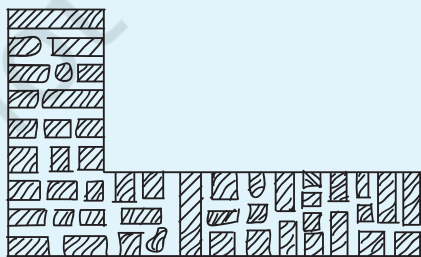

Plan

## Check Your Progress

### A. Short Answer Questions

1. Differentiate between ashlar masonry and rubble masonry.
2. What is the function of the following materials?  
(a) Through stone                      (b) Corbel  
(c) Cornice                                (d) String course
3. Explain the construction of a wall in coursed rubble masonry.
4. What type of stone masonry will you use for constructing the following?  
(a) Compound wall                      (b) Parapet wall  
(c) Retaining wall
5. What is the object of preliminary dressing of stone at site?

### B. Fill in the blanks

1. Stone masonry is constructed with stones and \_\_\_\_\_.
2. In cramped joint, cramps are used instead of \_\_\_\_\_.
3. Butt or squared joint is the most \_\_\_\_\_ joint and is extensively used for \_\_\_\_\_ work.
4. The stones of \_\_\_\_\_ sizes and shapes are used in rubble masonry.
5. Coursed rubble masonry is commonly used in the \_\_\_\_\_ of low height walls of public buildings, residential buildings, abutment and piers of ordinary bridges.
6. The curing for masonry should be done for minimum \_\_\_\_\_ weeks.

### C. Multiple Choice Questions

1. Stone used in construction work should be \_\_\_\_\_.  
(a) hard                                      (b) durable  
(c) soft                                        (d) tough
2. Mortar is prepared by mixing \_\_\_\_\_.  
(a) cement                                  (b) sand  
(c) water                                      (d) All of the above
3. Bottom surface of a door or a window opening is known as \_\_\_\_\_.  
(a) sill                                        (b) corbel  
(c) cornice                                  (d) coping
4. Small cracks should be cleaned with \_\_\_\_\_.  
(a) paper                                      (b) cloth  
(c) wire                                        (d) brush

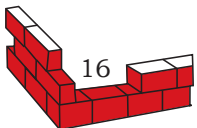

5. Butt joint is the most common joint and is extensively used for\_\_\_\_\_.

- (a) heavy work
- (b) small work
- (c) ordinary work
- (d) None of these

**C. Long Answer Questions**

- (a) Describe the tools used in stone masonry construction with a diagram.
- (b) Write a short note on uncoursed rubble masonry.
- (c) Write the different types of ashlar masonry. Explain any one.
- (d) How the maintenance of stone masonry construction is carried out?
- (e) Enlist the types of rubble masonry. Explain any one.
- (f) List the tools used in masonry work.

© NCERT  
not to be republished



# Brick Masonry



171103CH02

## INTRODUCTION

In brick masonry, the bricks are arranged and bedded in mortar so as to form a wall. In this process, uniform units of bricks are placed with one hand and these bricks are laid in courses with the mortar joints to form walls.

## MATERIAL USED IN BRICK MASONRY

The common materials employed for brick masonry construction are:

- (1) Brick
- (2) Mortar



Fig. 2.1: Brick and mortar

## Brick

A brick is a building material used to make walls, pavements and other elements in masonry construction. Bricks are manufactured by moulding the earth in rectangular blocks of uniform size and shape. The bricks can be manufactured of any shape and size as per the requirement. The standard size of a brick is kept as 19×9×9 cm.

Their nominal size is considered as 20×10×10cm. Generally, the first and second class bricks are used for brick work. Bricks should be tested for hardness and durability before they are used in masonry.

## Mortar

Mortar is a mixture prepared by mixing cement with sand. Water is added to prepare the mixture. Mortar keeps the stones in desired position. It is placed between the joints. Mortar is classified as per its use; the usage depends on the load coming on the structure, strength required, resistance desired for weathering agencies, etc. Lime mortar, cement mortar, cement lime mortar and lime cement mortar are different types of mortar.

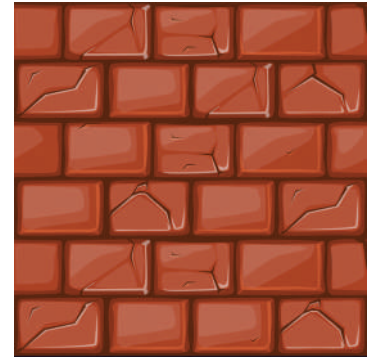

Fig. 2.2: Mortar in brick joining

## TOOLS REQUIRED FOR BRICK MASONRY

The various tools commonly used to form a brick layer are:

### Trowel

It is the most important tool used in brick masonry. It is available in sizes varying from 5 cm to 30 cm in length. Trowels are used for lifting and spreading mortar for forming joints and also for cutting bricks.



Fig. 2.3: Trowel

### Plumb Bob and Rule

It is in the form of a smooth wooden piece of 2 m length, 10 cm width and 1 cm thickness with its long edges parallel to each other. It is used for checking the verticality of the faces of brick work.



Fig. 2.4: Plumb bob and rule

### Straight Edge

This tool is used for checking the alignment of faces of brick work of a wall or pillar.



Fig. 2.5: Straight edge

### Mason's Square

This is a right angled piece made of steel or wooden section. It is used for checking right angles.



Fig. 2.6: Mason's square

### Spirit Level

This tool is used along with the straight edge for checking the levels of floors, roofs, etc.



Fig. 2.7: Spirit level



Fig. 2.8: Steel tape



Fig. 2.9: Brick hammer

## Steel Tape

This is usually a steel tape having millimeters length marked up to one tenth of a centimeter. It is useful for checking small measurements.

## Brick Hammer

One end of this hammer is square and the other end is sharp edged. It is used for cutting bricks in different shapes and sizes, brick paving, striking nails, etc.

## TECHNICAL TERMS USED IN BRICK MASONRY

### Bond

During construction work, the arrangement of laying of bricks is known as a bond. These adjacent bricks are joined with each other with the help of cement mortar. Various terms are described below, which are used for bond as per the arrangement of bricks.

### Course

A horizontal layer of bricks is termed as a course.

### Stretcher

When the bricks are laid lengthwise or in the direction of a wall, then it is called stretcher.

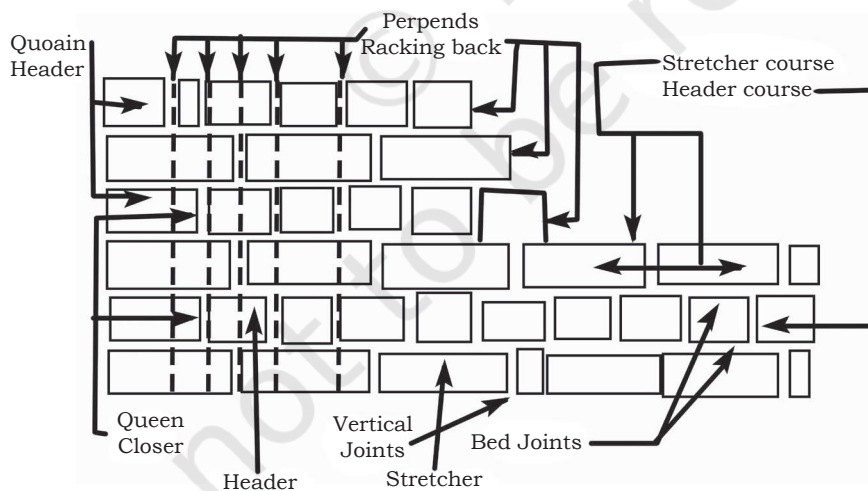

Fig. 2.10: Elevation of a masonry wall

### Stretcher Course

In this, the bricks are laid as stretchers. It is used for the partition of a wall.

### Header

When the bricks are laid breadth or width wise, it is known as a header.

### Header Course

When the bricks are laid as headers, it is known as header course.

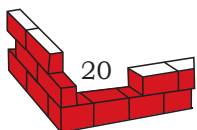

## Arises

The edge formed by the intersection of plane surface of a brick is called the arises and they should be sharp square and not damaged or chipped.

## Perpend

The vertical joints separating the bricks in either length or cross direction are known as perpend. For a good bond, the perpend in alternate courses should be vertically one above the other.

## Bed Joints

The horizontal layer of mortar upon which bricks are laid is known as a bed joint.

## Lap

The horizontal distance between vertical joint in successive courses is termed as a lap and for a good bond, it should be one-fourth of the length of a brick.

## Closer

A piece of brick which is used to close up the bond at the end of brick course is known as a closer. These are used for forming a proper bond in brick masonry. The types are:

### (a) Queen closer

This is placed next to the first brick in a header course. This is a half brick cut longitudinally.

### (b) King closer

To obtain a king closer joint, a brick is cut through length and width in such a way that a triangular portion is formed on the adjoining cut faces.

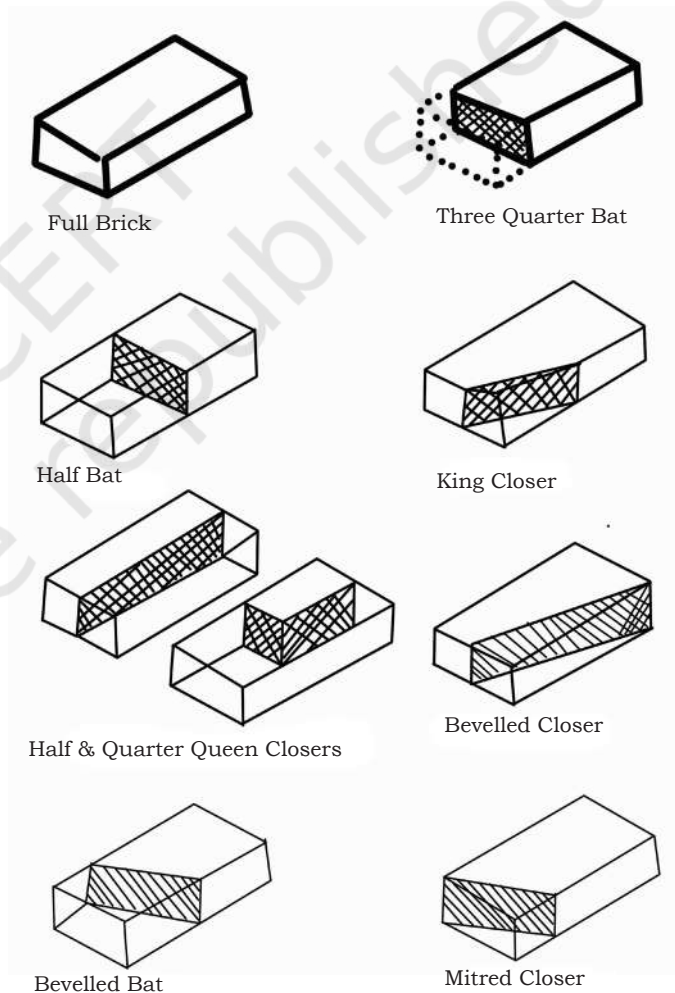

Fig. 2.11: Types of Closers and Bats

### (c) Bevelled closer

The portion of a standard brick made by cutting a triangular piece between the centre of one header face and the opposite corner of the stretcher face is termed as bevelled closer.

### (d) Mitred closer

The portion of a standard brick having its one end cut splayed or mitred for the full width is called a mitred closer (Fig. 2.11).

### **Bull nose**

The bricks moulded with a rounded angle is termed as bull nose and it is used for constructing the rounded corners of buildings.

### **Cow nose**

A standard brick having its both edges rounded off is called cow nose or double bull nose.

### **Plinth and plinth level**

The portion of a structure between the surface of surrounding ground and the surface of the floor immediately above the ground is known as plinth and the level of the top of plinth with respect to surrounding ground is known as plinth level.

### **Jambs**

The vertical sides of a door or window opening which support the door or window frame is called jambs.

### **Soffit**

The under surface of an arch or lintel provided over a door or window or verandah opening is called soffit.

### **Bond**

As we know, when bricks are laid adjacent to each other forming a groove in between the bricks which is filled by cement mortar, is called a bond. Bonding helps in even distribution of loads over a large area. Bonds are classified in different types.

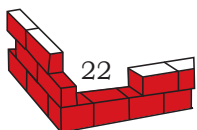



## English Bond

This bond consists of alternate course of headers and stretchers (Fig. 2.12). Queen closer, i.e., half of the brick cut lengthwise, shall be introduced after first header to break the vertical joint.

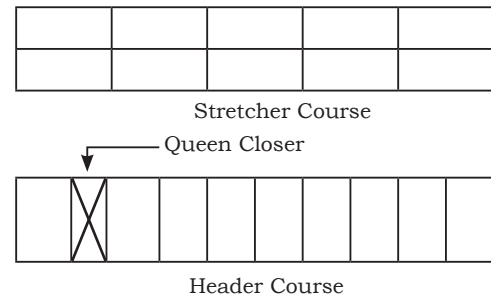

Fig. 2.12: English Bond

## Flemish Bond

In this arrangement of bonding brickwork, each course consists of alternate headers and stretchers. The headers of each course are centred over the stretcher in course below. For breaking of vertical joints in successive courses, closers are inserted in alternate courses next to quoin headers (arrangement of bricks) (Fig.2.13).

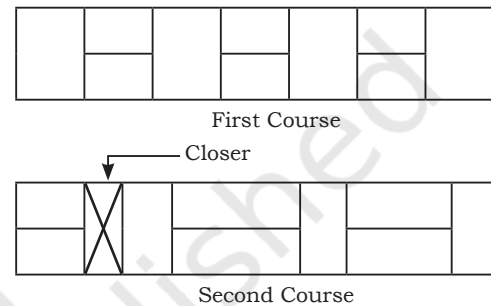
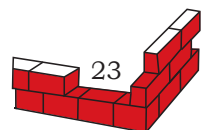

Fig. 2.13: Flemish Bond

## GENERAL PRINCIPLES TO BE OBSERVED IN BRICK MASONRY CONSTRUCTION

While supervising the construction of a brick wall the following points should be observed.

1. The brick to be used for masonry work should be well burnt and of uniform size.
2. All the bricks to be laid in cement or lime mortar must be properly soaked in water for at least two hours before they are used in construction work.
3. All the bricks should be laid with their frog upwards so that the mortar should be properly filled in the frog and should form a key with mortar joint of the succeeding course.
4. Specified mortar of good quality should be used.
5. All joints of the masonry should be of uniform thickness and the thickness of each joint should not exceed 1 cm.
6. A systematic bond must be provided throughout the masonry work.
7. The verticality of the brick work should be frequently checked by means of a plumb rule.



8. The upper surface of the wall should be wetted properly before a new layer is laid over it so as to form a bed for the new work.
9. The brick work should be uniformly raised throughout the length of the wall in proper bond to avoid any unequal settlement.
10. In one day, the height of brick masonry construction should not exceed 1.5 metres.
11. While constructing a long wall, each successive portion should be properly raked back and the old and new brick work should be joined according to the bond.
12. Brick bats should be used to the minimum.
13. When timber or iron work is to be embedded in the wall, the timber must be coated with coal tar and the iron work to be laid either in cement mortar or cement concrete.
14. Freshly laid brick work should be protected against rains during construction.
15. During frosty weather, the brick work should either be suspended or carried out in cement mortar, if essential.

### **METHOD OF LAYING BRICKS FOR THE WALL**

The following are the steps adopted in the construction of walls.

#### **Selection of Bricks**

Bricks are selected for different parts of the wall i.e., for facing, hearting and backing.

#### **Wetting of Bricks**

Before the bricks are laid in the walls, they should be wetted on all sides. The reasons for wetting bricks are:

- (i) The bricks will tend to spread the mortar under them more evenly.
- (ii) They will adhere better to the mortar.

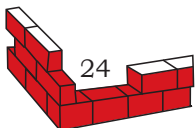

- (iii) A dry brick will quickly absorb water from mortar and water is needed for setting of cement mortar.
- (iv) Wetting of bricks washes the kiln dust from them. A clean brick will produce a better joint and bed with mortar.

### **Preparation of Mortar**

The mortar to be used for brick masonry is prepared the required quantity at one time. The quantity of mortar should be such that it can be used within half an hour after its preparation.

### **Laying of Bricks in Walls**

Laying of bricks in wall is done in the following two steps:

- (a) Laying of bricks in foundation i.e., up to plinth level
- (b) Laying of bricks in wall above plinth level

### **Laying of bricks in foundations**

This is done by following the given steps:

#### ***(i) Spreading mortar on concrete bed***

About 2 cm thick layer of prepared mortar is first spread on the top of concrete bed in the area to be occupied.

#### ***(ii) Constructing corners***

After spreading the mortar, the extreme corners are constructed in two courses after leaving the required concrete offset on each side. Surfaces of these extreme corners are made truly plumb.

#### ***(iii) Laying first course***

First of all, two strings are stretched at the upper level between extreme corners to mark the external and internal edges and to lay the bricks in the line and level with corner bricks of this course. Then bricks are laid on the layer of mortar in between these strings till the first course is completed.

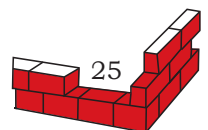

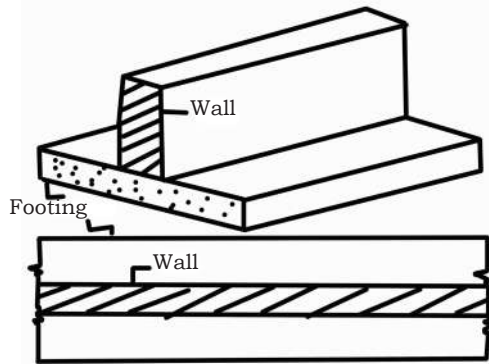

Fig. 2.14: Simple footing in brickwork

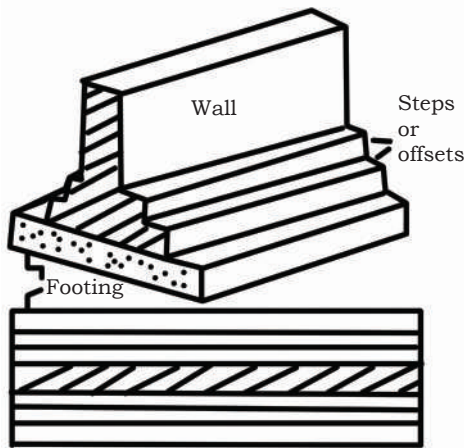

Fig. 2.15: Spread footing in brickwork

#### (iv) Laying second course

In second course, two strings are stretched at the upper level between the extreme corners and bricks are again laid on the layer of mortar till it is completed. Similarly, the remaining steps of foundations of wall are completed after leaving the bricks offset (Fig. 2.14).

#### Laying of bricks in wall above plinth level

First, a layer of 2 cm of thick mortar is spread on the top of plinth course in the area to be occupied by the corners of the wall. Then the extreme corners of the wall are constructed in the required bond up to 3–5 course in height. The base of each corner is extended in steps as shown in figure 2.15. The surfaces of the corners are made truly plumb. After this, each course is completed in turn by stretching two threads at its upper level between the extreme corners to work the external and internal edges of the wall. In each course selected bricks for facing work are laid first in line and levelled with the external thread and then other bricks are laid in between the internal thread. When the masonry work up to the top of these extreme corners is completed, extreme corners of 3 to 5 courses in height are again constructed and this process is repeated till the wall is constructed up to a height of 1.5 m from ground level.

### METHODS OF FIXING NEW BRICK WORK WITH OLD BRICK WORK

- (1) Tothing
- (2) Racking back
- (3) Block bonding

#### Tothing

Tothing is the process of leaving alternating openings (teeth) for an adjoining brick wall to be started from. This

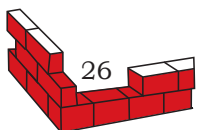

makes the adjoining wall to be started without having to adjust or cut the brick. This method is used when a partition wall is proposed to be connected with the main wall or when rest of the building portion is to be constructed afterwards. The length of recesses left in the wall is kept equal to the thickness of the proposed partition wall and their depth is equal to 1/4 brick or 5 cm. Tothing is done so that the new cross or partition wall or rest of the wall can be bonded to the existing wall properly.

### **Racking Back**

This method is useful when full length of the wall cannot be built at one time. In this method, the full length of the wall is constructed in parts and each successive portion is racked back. Racking back is done to reduce the possibility of any settlement of cement plaster in freshly laid portion of the wall.

Racking Back refers to the stepping back of courses of brick during the construction phases of a wall. This method is used for fixing new brick work with the old brick work.

### **Block Bonding**

This method is used for joining a new course or partition wall to existing main wall. The process of creating recesses in height after every three courses in the existing main wall is called block bonding.

## **DEFECTS IN BRICK MASONRY**

Common defects occurring in brick work are:

- (i) Sulphate effect on mortar
- (ii) Use of unsound material
- (iii) Frost action
- (iv) Efflorescence

### **Effect of Sulphate on Mortar**

Exposure to sulphate causes cracking of brick work, spalling of brick edges, deterioration of mortar and falling off the plastered surface. The cause of this failure is chemical action that takes place between the sulphate salts present in bricks and aluminium constituent of the portland cement.

This action is rapid in the presence of water. Prevention of moisture penetration will avoid this effect to a large extent.

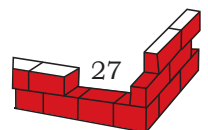

## **Use of Unsound Material**

When sub-standard material such as under burnt or over burnt bricks, poor quality mortar, etc., are used, it may result in dampness, cracking and early failure of the structure. To overcome this defect, materials of good quality should be used.

## **Frost Action**

Defects due to frost action would cause cracking in the brick work. Prevention of water accumulation would go a long way in reducing this defect.

## **Efflorescence**

The accumulation of white deposits on the exposed surfaces of bricks in brick masonry is called efflorescence.

It is due to the crystallisation of salts present in the bricks or absorbed by them from the soil in contact with the brickwork. This provides an ugly appearance and may cause disintegration of the brick work. To overcome this defect, sound bricks in good mortar should be used in brick work. Damp-proof course should be well designed and provided properly in the required position to overcome dampness in the brick work.

## **MAINTENANCE OF BRICK MASONRY**

Maintenance is done to ensure neat appearance and stability of the brick work. Following steps are generally executed for proper maintenance.

### **Cleaning Brick Masonry**

Cleaning of brick masonry is done to ensure the neat appearance of brick work, cleaning is done either by steam or hot water jets.

### **Removing Efflorescence**

Efflorescence is removed by rubbing the surface of brick masonry with wire brush and then washing with water. If this is not effective, the surface is treated with a 10percent solution of muriatic acid and then washed immediately with plain water.

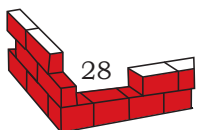

## Reconditioning of Brick Masonry

To ensure the neat appearance and reconditioning of brick masonry, repointing or replastering is done.

For repointing the loose mortar from the joints, loose mortar is removed to a depth of about 3 mm. The joints are then cleaned by means of a wire brush and washed with water. After this, the joints are finished with fresh mortar.

For replastering, loose plaster from the surface is removed to a depth of 3 mm. The surface is then cleaned with water. After this, the surface is replastered.

### Practical Exercise

These activities are to be done under the supervision of teacher in the school premises.

1. Perform the stacking of bricks and counting of bricks as per the laid standard procedure.
2. Construct English bond of one brick's thickness without mortar.
3. Construct English bond of one and half brick's thickness without mortar.
4. Construct double Flemish bond of one brick's thickness without mortar.
5. Construct single Flemish bond of one and half brick's thickness without mortar.
6. Prepare different types of closers.
7. Prepare different types of brick bats.
8. Construct English bond and Flemish bond as per the drawing given below.

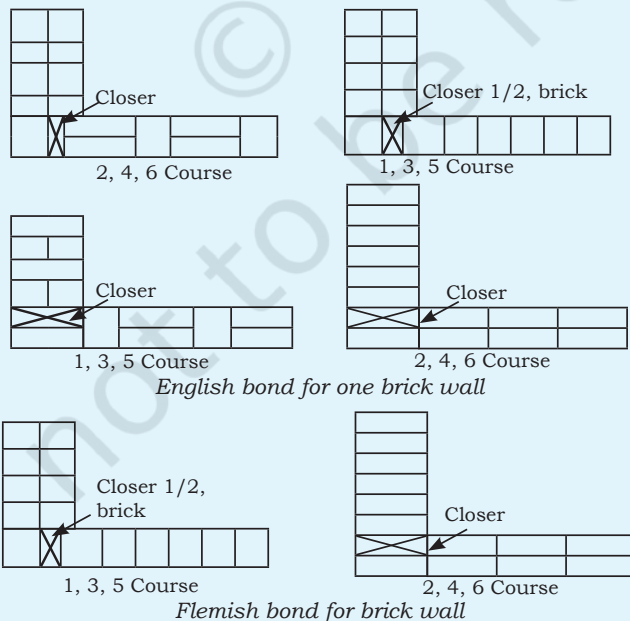

## Check Your Progress

### A. Short Answer Type Questions

1. Give the general principles to be observed and precautions to be taken during the construction of brick masonry.
2. Define the following with diagrams.
  - (i) King closer
  - (ii) Queen closer
  - (iii) Standard brick
  - (iv) Bull nose
3. What is a bond in masonry? Why is it necessary?
4. Why are joints broken in masonry?
5. Explain the following terms:
  - (i) Tothing
  - (ii) Racking back
  - (iii) Block bonding

### B. Fill in the blanks

1. A horizontal layer of bricks is termed as a \_\_\_\_\_.
2. Course of brick work in which all the bricks are laid as headers are called as \_\_\_\_\_ course.
3. Bricks are manufactured by \_\_\_\_\_ the earth in rectangular blocks of uniform size and shape.
4. Trowels are used for \_\_\_\_\_ and \_\_\_\_\_ mortar for forming joints and also for cutting bricks.
5. Plumb rule and bob are used for checking the \_\_\_\_\_ of the faces of brick work.
6. In the stretcher course of brick work, all the \_\_\_\_\_ are laid as stretchers.
7. Straight edge is used for checking the \_\_\_\_\_ of faces of brick work of a \_\_\_\_\_ or pillar.
8. \_\_\_\_\_ is a brick laid with its breadth or width parallel to the face or front or direction of a wall.

### C. Multiple Choice Questions

1. Trowel is an important tool used for \_\_\_\_\_.
  - (a) Brick masonry
  - (b) measurement of item
  - (c) breaking the stone
  - (d) measuring the distance
2. The shape of the brick hammer is square on one end and the other end is of \_\_\_\_\_.
  - (a) oval shape
  - (b) sharp edged shape
  - (c) flat shape
  - (d) round shape

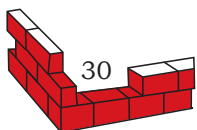



3. Jambs is a term used to denote the \_\_\_\_\_ or window frame.  
(a) horizontal side of door      (b) vertical side of door  
(c) lateral side of door      (d) none of these
4. \_\_\_\_\_ is a defect of frost action.  
(a) Cracking in the brick work  
(b) Tightening in the brick work  
(c) Hardening in the brick work  
(d) None of these
5. Brickbat is also known as \_\_\_\_\_.  
(a) Full brick      (b) Half brick  
(c) Powder brick      (d) None of these

**D. Long Answer type Questions**

1. What are the common defects in brick masonry?
2. What are the advantages and disadvantages of English bond and Flemish bond?
3. Enlist the different types of bonds used in brick masonry.
4. Describe the procedure of laying of bricks in a wall.
5. Differentiate between English bond and Flemish bond.
6. Explain the tools used in brick masonry.



# Plastering Work



171103CH03

## **PLASTERING AND ITS IMPORTANCE**

The walls constructed with bricks or stones do not have a fine texture generally. To obtain an even, smooth, regular and clean surface of walls, a covering material like mortar is applied on the surface. The application of mortar is known as plaster. We can say that plaster is a layer of cement-sand-mortar, applied over the masonry work, which also acts as a damp-proof coat over the masonry work. Plastering enhances the appearance of the building. The ceiling is also made smooth with the plaster. It also provides a smooth base for distemper and paint.

### **Purposes of Plastering**

- (i) To get an even, smooth and durable surface.
- (ii) To safeguard the surface from the effects of weathering agencies.
- (iii) To provide a smooth surface for decorative surface finish.
- (iv) To conceal the bad workmanship.

## Requirement of an Ideal Plaster

- (i) It should be strong and durable against the effect of weathering agencies.
- (ii) It should offer good resistance against fire.
- (iii) It should give a smooth and washable surface.
- (iv) It should provide a smooth surface with the required decorative effect.

## Tools Used in Plastering Work (Fig. 3.1)

1. Wooden float or Metal float
2. Trowel
3. Water pipe
4. Measuring tape
5. Aluminum hollow box section
6. Tacha or Brick axe
7. Plumb bob
8. Patti for making groove
9. Spade
10. Mortar pan
11. Chisel
12. Hammer
13. Right angle, small and big
14. Screen for sieving sand
15. Measuring jar
16. Wire brush
17. Measuring boxes for measuring sand

## Material required for plastering

- (i) Cement
- (ii) Sand
- (iii) Water
- (iv) Admixture (if any), for example, waterproofing compound

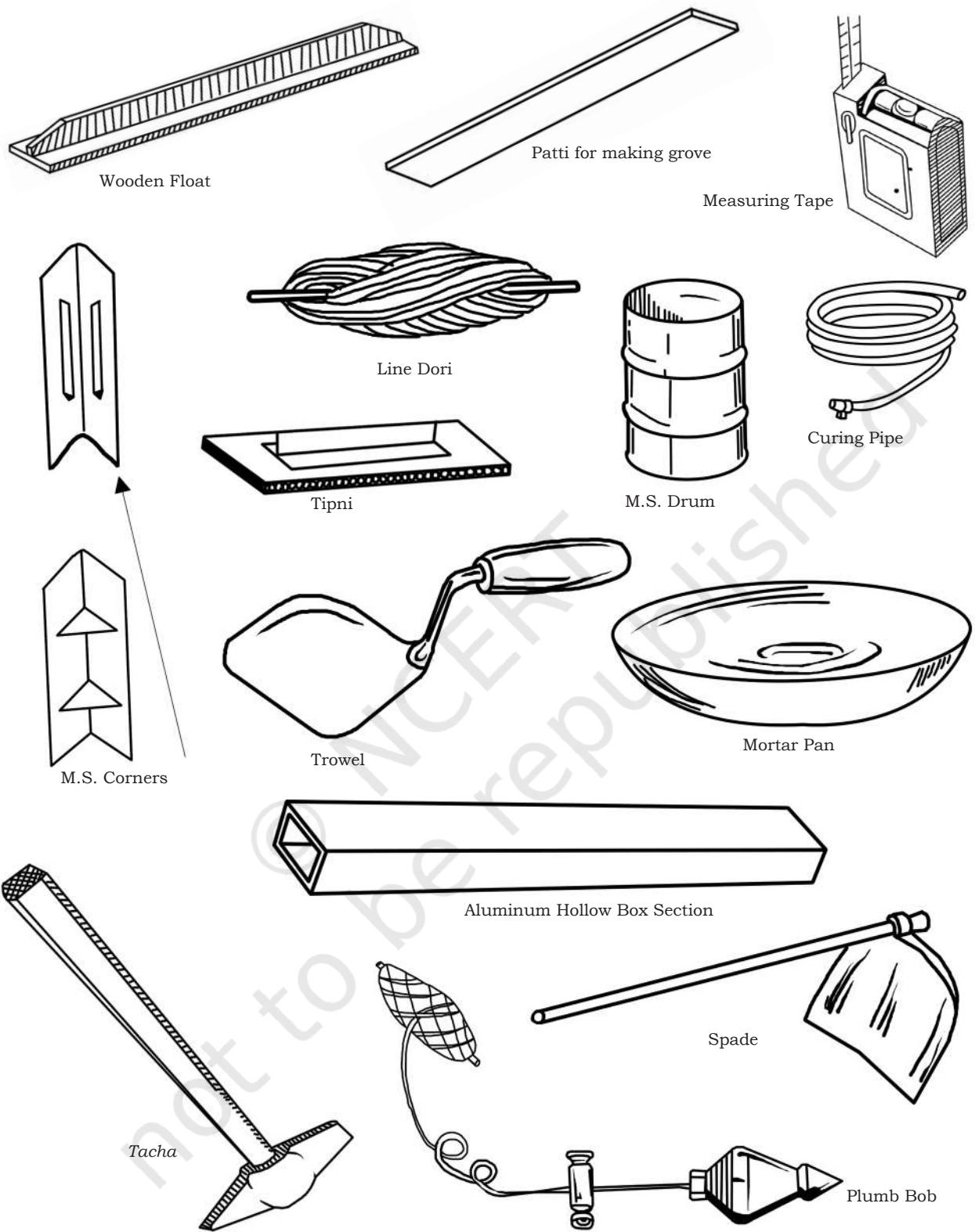

Fig: 3.1: Tools used in plastering work

## Types of plaster

- (i) Cement plaster
- (ii) Lime plaster
- (iii) Mud plaster

### Cement plaster

The plaster in which cement is used as a binding material is known as cement plaster. Cement and sand is mixed in the proportion from 1:3 to 1:6 with the help of water so that cement plaster can be used smoothly.

#### **Steps to be followed in cement plastering**

For coating of internal and external surfaces of a wall, cement plastering is done commonly. Generally cement plastering is done in single coat. For higher thickness more than 15 mm, double coat of cement plastering is done. Sometimes, for very fine finishing, double coating of cement plastering is done. Following steps are followed for doing double coat cement plastering work.

The process of applying a double coat cement plaster on wall surface consists of the following 5 steps.

- (a) Preparation of surface
- (b) preparation for plaster
- (c) first layer of coating of plaster
- (d) second layer of coating of plaster coat (fine finishing coat)
- (e) Curing of finished plaster surface

#### **Procedure for cement plastering**

##### *(a) Preparation of surface*

1. All the mortar joints of wall should be made rough, so that a good bonding is created for holding plaster.
2. With the help of a wire brush, clean all the joints and surfaces of the wall and check that, oil or



Fig. 3.2: Plastering with machine



Fig. 3.3: Plastering with manual labour

grease etc. are not left on wall surface.

3. When plastering is to be done in old smooth wall or surface then mortar joints should be raked out for at least 12mm depth. This process help better bonding to the plaster.

4. It is necessary to remove the projection etc on the wall, if it is more than 12mm. This will give smooth surface as well reduce the consumption of plaster.
5. Cavities and hole seen in wall should be filled with appropriate material before plastering.
6. Wall should be properly roughened prior to plastering.
7. All the mortar joints and wall should be washed properly and kept wet for six hour prior to cement plastering.

*(b) Basic preparation for plaster*

1. For getting uniform thickness of plaster in a surface, dot system should be promoted. In this process, a patch of plaster having thickness of 10mm and size of 15×15mm should be fixed horizontally as well as vertically at a distance of 2 meter.
2. With the help of plumb-bob and line dori should be used for horizontal and vertical line of dots.
3. After setting the dots, vertical strip of plaster is placed between the dots. This vertical strip is called as screeds. It helps in maintaining uniform thickness of plaster.
4. Similarly, other walls are plastered in same process.

- Use of mason square is made for checking right angle.

(c) *Applying second layer of coating of plaster coat (fine finishing coat)*

- Generally for second coat, thickness of plaster varies between 2 to 3 mm.
- The ratio of cement and sand varies between 1:4 to 1:6 for second coat plaster.
- First coat should be dampened prior to second coat.
- Similarly with the help of wooden float and steel trowel, finishing coat is made.
- To avoid joining marks, finishing coat is made from top end of wall to bottom in one operation.

(d) *Curing of finished plaster surface*

After plastering work to achieve strength and hardness surface, plaster wall should be kept wet for 7 days.

(For ceiling plaster work, levels are marked on the wall with level tube and then dots are marked and screeds are filled on the ceiling.)

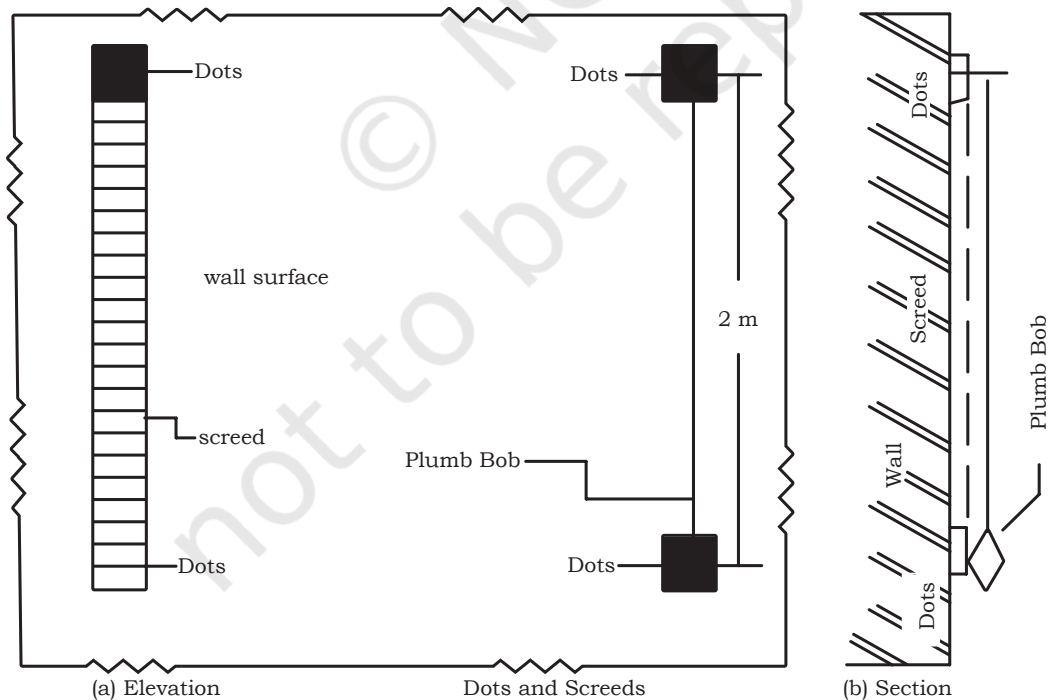

Fig. 3.4: Curing of finished plaster surface

## Lime plaster

The proportioning of ingredients in lime mortar is different and adopted according to the number of coats. If one-coat lime plaster is applied, the proportion is kept 1:2 i.e., one part lime and two parts sand. If two coats are applied, the proportion for the first is same but proportion for the second coat is kept 2:1 i.e., two parts lime and one part of sand. In three coats of plaster, the proportion for the third coat is kept 4:1 i.e., four parts of lime and one part of sand. The thickness of the lime plaster varies from 18–25 mm.

Lime plaster is suitable for internal rendering of the building, but it is not common these days.

### ***Steps to be followed in lime plastering***

#### *Preparing the surface*

This step of preparing the surface is the same as in the case of cement plastering.

#### *Application of plaster coats*

Lime plaster is also applied in one, two or three coats. In the first coat, lime plaster is applied with the help of trowel against wall surfaces between the screeds. The necessity of this coat is to fill all irregularities of the surface. First coat is left to dry for three to four days before applying the second coat.

For the application of the second coat, it is essential to wash the first coat and scratch over it with the edge of a trowel. Lime plaster is then applied with the help of a mason's trowel. The thickness of the thin coat is generally kept between 8–10 mm.

After applying the coat, finished coat is applied. This coat usually consists of fat lime. It is essential to make surface of the second coat perfectly plain, it is rubbed first with a wooden float then with a steel float to polish the surface. It is about 3–6 mm in thickness. It is allowed to dry for two days and then the surface is cured for at least two weeks.

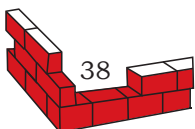



## Mud plaster

This type of plastering is suitable to be put on the walls of temporary sheds and low cost countryside buildings.

In the plastering work, the surface of the wall is prepared first as in the case of cement plastering. The plaster is then evenly applied on the wall surfaces and dashed with wooden float. The surface is then damped after 24 hours. The importance of damping is to compact the layer and fill the joints deeply with mud mortar.

After damping, the surface is then polished with a steel trowel. If any small cracks develop, a thin wash of cow dung is given and damping is done again.

## External Finishes

It is essential to finish external walls of the building by using suitable material depending upon the desired appearance and degree of maintenance. There are various forms of external finishes. The common types of external finishes are:

- (1) Sand faced finish
- (2) Pebble dash finish
- (3) Rough Cast finish
- (4) Smooth cast finish

## Sand faced finish

This is done in two coats. In the first coat, cement mortar of 1:3 to 1:4 is applied on the prepared surfaces of wall. The thickness of the first coat should not exceed 12 mm. After application of the first coat, it should be cured for atleast one week. The first coat should be provided with scratches so that the second coat adheres with the first coat. The second coat is then applied with cement mortar of 1:1 in proportion. The thickness of coat is generally kept between 8 to 10 mm. The sand to be used in the second coat should be perfectly screened to get a uniform finished surface. After completion of the second coat, the surface is kept out for at least 15 days.

### Pebble dash finish

In this type of finish, it is essential to make 12 mm thick finishing coat. Then the clean pebbles of 10 to 12 mm size are dashed on the surface of finishing coat, so that the pebbles hold position by the mortar already applied.

### Rough cast finish

In this mortar, the cement mixture proportion is kept 1:3 and then coarse grained sand is used. The mortar is applied on the surface of wall and is roughly finished by light movements of the wooden float.

### Smooth cast finish

In this finish, the procedure is same as that of rough cast finish, but the sand used is fine grained in place of coarse grained.

### Defects of Plastered Surface

1. Sometimes small patches or conical holes (popping) swell out of the plastered surface.
2. Fine hair cracks develop on the plastered surface.
3. If some salt is available in the material of plaster, the salt is brought out to the surface of wall and it appears in the form of whitish crystalline structure. This is called efflorescence and seriously affects the adhesiveness of paint with wall surface.
4. Due to bond failure between successive coats of plaster, the plaster from some portion comes off. This is known as peeling.
5. Due to the thickness of finishing coat or the presence of deliquescent salt, certain paints on plastered surface makes the portion soft.

To minimise the defects in plastered surface, following points should be kept in mind:

- Brick and other material of superior quality should be used.
- Water free from salts should be used.

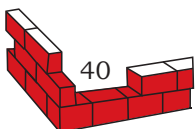

- The surface should be well watered before plastering.
- The construction should be such that the entry of moisture should be avoided.
- Fresh plastered surface should be saved from the superfluous quality of water.
- Excess trowelling should be avoided.

## Repairs to Plastered Surface

The small cracks developed in the plastered surface can be repaired by grouting slurry of cement sand mortar.

For damaged plastered surface, the patches are cut out in square or rectangular shape. The patch is then cleaned and wetted with water. The patch is filled with the plaster of rich ratio (more cement and less sand). The surface is then finished according to the adjacent surface and cured properly.

Efflorescence is removed by rubbing the surface and cleaning it with a brush. Then a solution of water and hydrochloric acid/sulphuric acid in the ratio of 5:1 is applied on the cleaned surface. The surface is then thoroughly washed and rendered clean and dry.

## Check Your Progress

### A. Answer the following

1. Write the importance of plaster in a building.
2. List the various types of plasters and their suitability.
3. What are the requirements of an ideal plaster?
4. Describe the procedure adopted in plastering of the wall.
5. What precautions should be taken for avoiding plastering defects?
6. What are the purposes of plastering?
7. How the defects of plaster work can be corrected?

### B. Fill in the blanks

1. To obtain an even, smooth, regular and clean surface of walls, a covering material like mortar called as \_\_\_\_\_ is applied on the surface.
2. Material required for plastering are cement, \_\_\_\_\_, water and admixture (if any).

3. In case of brick masonry, the thickness of first coat plaster is generally \_\_\_\_\_ mm.
4. Due to bond failure between successive coats of plaster, the plaster from some portion comes off. This is known as \_\_\_\_\_.
5. Efflorescence is removed by rubbing the surface and cleaning it with a \_\_\_\_\_.

### C. Multiple Choice Questions

1. Plaster made from the following items is known as Cement plaster.  
(a) Cement, sand, water                      (b) Lime, sand, water  
(c) Mud, sand, water                          (d) None of these
2. Proportion of lime plaster for first coat is \_\_\_\_\_.  
(a) 1 part lime : 2 parts sand              (b) 1 part lime : 3 parts sand  
(c) 1 part lime : 4 parts sand              (d) None of these
3. In pebble dash finish, thickness is kept as \_\_\_\_\_.  
(a) 10 mm                                          (b) 12mm  
(c) 14 mm                                          (d) 16 mm
4. Mud plaster is done on \_\_\_\_\_.  
(a) temporary sheds                              (b) *pucca* shed  
(c) RCC block                                      (d) None of these
5. Ratio of cement and sand for second coat plaster varies from \_\_\_\_\_.  
(a) 1:2 to 1:3                                      (b) 1:4 to 1:6  
(c) 1:5 to 1:6                                      (d) None of the above

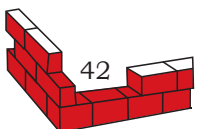



# Precast Block Masonry

## WHY PRECAST BLOCK MASONRY?

Since a long time, bricks are being used as prime building material. Bricks are being used in thatched houses and for multi-storey buildings. Due to growing population and subsequent need of housing, there is a great demand of bricks. Shortage in supply of bricks is due to the scarcity of raw material.

If we continue to use the bricks, it will ultimately lead to the erosion of fertile land. We have to protect our resources. Apart from this, due to the scarcity of skilled labour, increasing cost of kiln fuel and demand and supply ratio of bricks, there is a need to find an alternative to the bricks.

One such alternative to the bricks is precast block masonry or concrete block. Advantage of concrete blocks is that they can be manufactured on the sites.

When a constructed product like concrete block, brick, pole, pots, etc., is produced by casting concrete in a reusable mould, then it is known as precast concrete product. Precast concrete product is produced in controlled conditions. These products can be fabricated at construction site also, thus saving transportation cost.



171103CH04

Concrete blocks can be manufactured at the site, which is a great advantage. We can say that precast concrete is simply concrete that is casted at any place other than where it will be used. Precast concrete blocks are used as bricks in the construction of wall, pavement block, boundary wall, partition wall, flower pots, etc.

## **ADVANTAGES AND DISADVANTAGES OF USING PRECAST BLOCK MASONRY**

### **Advantages**

1. Superior quality of precast concrete product is produced due to better technical control practised in a manufacturing unit.
2. During precast construction, it is not necessary to provide joints.
3. The labour can be easily trained for manufacturing precast products.
4. To prepare the precast products, moulds of steel are used which have exact dimensions in all the directions. Life of these moulds is longer and can be used many times.
5. Precast concrete products can be easily given desired shape, as per the requirement, with proper finish and accuracy.
6. The moulds can be dismantled and assembled easily as per the requirement.
7. Transport and storage cost is reduced when precast concrete products are used.
8. Due to adoption of precast units, the construction and installation work of unit takes less time.
9. The amount of scaffolding and form work is reduced while adopting precast structure.

### **Disadvantages**

1. Improper handling of precast units may lead to their damage.

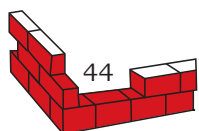

2. Sometimes, joining of precast units is difficult to produce satisfactory level.
3. Specific equipment are required for lifting and moving of precast units.
4. Due to high handling and transportation cost, it becomes necessary to establish a precast units producing factory near the site in order to reduce the cost.

## Material for Construction

Important materials required for this block are cement, sand and water. The mortar ratio should be 1:1 and 1:2 (cement: sand).

## Tools and Machines Required for Block Casting

- Block making machine, hand operated with and without vibrator and electrically operated with vibrator
- Block pallets, wooden or M.S. (Mild Steel)
- Spades (*Phavdas*)
- Mortar pans (*Ghamelas*)
- Measuring boxes
- Compacting rod
- Trowel (*Thapi*)
- Painted plates for ensuring the casting dates
- Curing pipes
- Sprinklers

## Block Making Machine

There are two types of block making machines.

- Hand operated machine with and without vibrator.
- Electrically operated machine with vibrator attachment. For better compacted block with more strength, electrically operated machine with vibrator attachment is preferred than the hand compacting machine. But since it

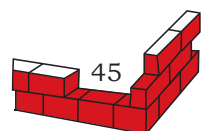

is expensive, hand compacting machines with vibrator can be used for smaller projects.

### Block Pallets

- Block pallets may be made of wood or mild steel.
- Wooden pallets are generally made of sal wood and can be of different sizes. Pallet size should be about 3 mm less than the actual block size. M.S. pallets are made from 14 gauge M.S. sheet and angles welded at the bottom.
- Oiling and cleaning of block pallets should be done every week and repairs should be carried out periodically.
- Cleaning, oiling and maintenance of the block casting machine should also be carried out periodically.
- Block pallets of a special size and shape are used for producing half length blocks.

### Basic Material

For manufacturing blocks, basic material required is cement, sand, shingle (coarse sand), metal, grit, dust, etc.

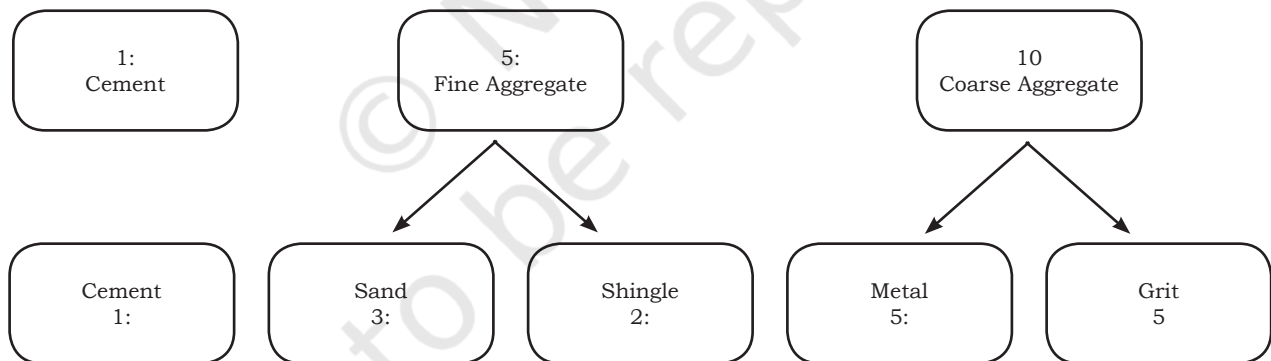
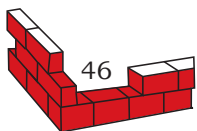

Fig. 4.1: Proportion of Material

### Proportions of Material

Materials can be used in the following proportion for manufacturing non-load bearing block to get the required strength and about 35 blocks or bags of cement.





## Block Manufacturing Procedure

The given procedure should be followed for manufacturing the blocks.

- Concrete block should be of sizes 30cm × 150cm × 20cm or 30cm × 10cm × 20cm.
- A platform should be prepared by laying P.C.C.
- Size of the platform should be large enough to mix at least 25 deposes (heaps).
- On this platform, deposes of the material should be dumped for each cement bag.
- Generally, the contractor mixes one depo of five to six bags of cement at a time leading to improper mixing, ultimately affecting the strength of the block.
- Mix the cement thoroughly to get a uniform dry mix.
- Then water should be added in the depo and wet mixing should be done thoroughly.
- Water cement ratio should be kept very low, as higher water cement ratio block cannot stand for a long time.
- Now, compact the concrete.
- Compaction is important for manufacturing the blocks, since the strength of the block depends on how well the block is compacted.
- To make the block fully compacted, the moulds should be filled in layers and compaction done by tamping rod or electrical vibrator.
- By using a hand operated machine, 25 strokes are required per layer; while it takes 15 seconds to compact the block completely by using electrical compaction.
- These blocks are then carried manually to the initial stacking yard for setting.
- Similarly, hollow blocks can be prepared by making certain changes.

## Half Blocks and Other Size Blocks

- Generally 5 per cent half brick blocks are used in block masonry.
- These blocks are used at corners, near windows, etc.

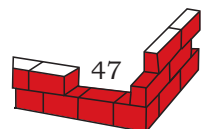

- Making two blocks by breaking one full block is not feasible at the time of construction. Also, it can lead to an increased breakage of the blocks, resulting in wastage.
- To avoid wastage, half size block of 15cm × 15cm × 20cm or 10cm × 15cm × 20cm should be manufactured as per the requirement. Special types of pallets are used for this.

## Requirement of a Quality Block

### Shrinkage period

- Blocks require a minimum of 15 days curing for attaining the required strength.
- The blocks can be used after sufficient curing.
- A time gap of at least 90 days between the manufacturing date and utilisation date of the blocks is advisable. It is necessary to complete shrinkage process in the newly prepared blocks.
- Chances of developing shrinkage cracks in the masonry reduce considerably with a sufficient time gap.
- So, block manufacturing should commence at least 90 days in advance.
- Accordingly, the procurement of basic material should be done.

### Curing of the blocks

Curing of the blocks should be done for minimum 28 days for getting the required strength.

### Strength and testing of the concrete block

- The minimum compressive strength required for load bearing solid concrete blocks is  $4\text{N/mm}^2$  ( $40\text{ kg/cm}^2$ ) at 28 days. However, the I.S. Code does not specify any particular limit of non-load bearing solid concrete blocks. Practical site experience indicates that the minimum compressive strength required for

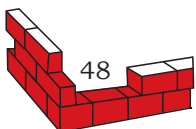

these blocks should be between 2.5 to 3N/mm<sup>2</sup> (25 to 30 kg/cm<sup>2</sup>) at 28 days.

- Field tests and laboratory tests are carried out to check the quality of the block.

### **Stacking of the Blocks**

The following steps are involved in stacking of the blocks.

- Freshly prepared blocks should be kept in a row, with a gap of 5 cm or 7 cm gap, for at least 24 hours, without any disturbance for initial setting of the concrete.
- After 24 hours, the pallets can be removed from the base of the block by turning the block slowly on its side.
- The block should be allowed to lie in the same position for another 12 hours before stacking it in the stacking yard. Curing of these blocks should be done at least four times a day.
- The blocks should then be carried to the stacking yard for stacking and curing.

### **Requirements of a Good Stacking Yard**

- Good stacking yard should be properly leveled with ample space with shade.
- Generally the parking place of the building or the shaded area under a big tree makes good stacking yards.
- Water connections should be provided in the stacking yard at convenient places for easy curing.
- The blocks should be stacked in rows and heaps, with a gap of 5 cm between each stack for ventilation.
- There should be a gap of 1 m after every 20–25 rows for easy lifting of the blocks.
- Each stack of block should contain six numbers of blocks placed one above the other.
- Blocks should be stacked in such a way that the edges of every individual block remain intact.

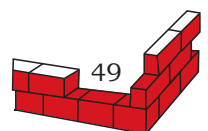

- The casting date number plate should be kept on the stack for ensuring the curing days of the blocks.

### Flow chart of Block Manufacturing

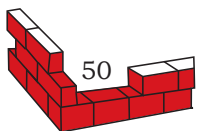
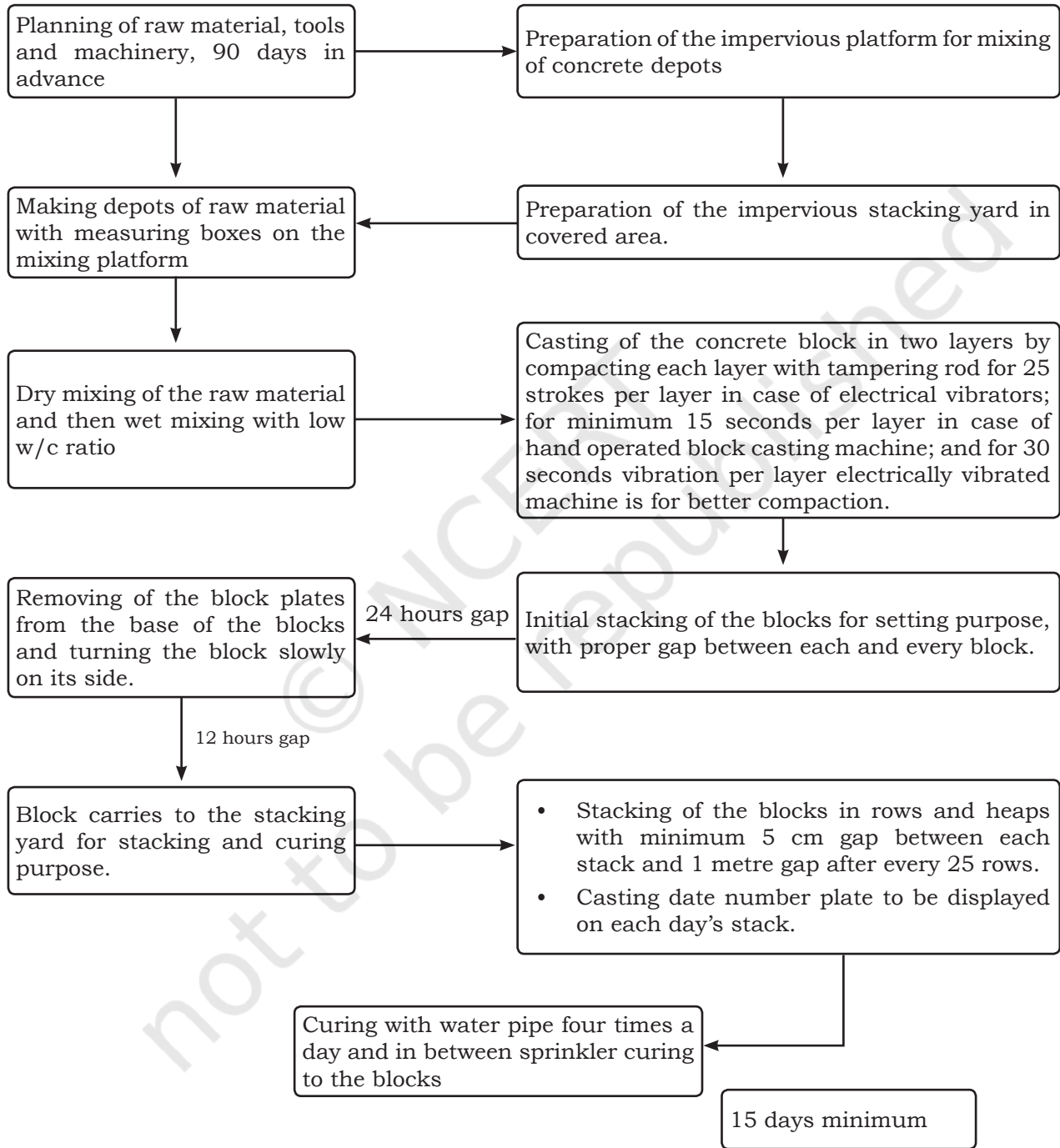

## Curing of the Blocks

Curing is the most important activity for the production of blocks. All efforts to produce quality blocks will be useless if curing is not done properly.

The following steps should be observed during the curing of the blocks.

- Cure the individual stack.
- Ensure that the lowermost block in the stack has soaked water.
- Generally, to finish the work quickly, the curing person waters only the top layer of the stack and the remaining layers remain uncured.
- Curing of the blocks should start immediately after stacking and it should continue for at least fifteen days after the casting date.
- Curing with a water pipe at least four times a day is essential for every block.
- In addition to pipe curing, sprinkler curing is also advisable.
- Due to sprinkler curing, the blocks remain moist all the time, resulting in an increase in the ultimate strength.
- Number plates indicating casting date should be strictly displayed every day on the stack for easy supervision of curing.

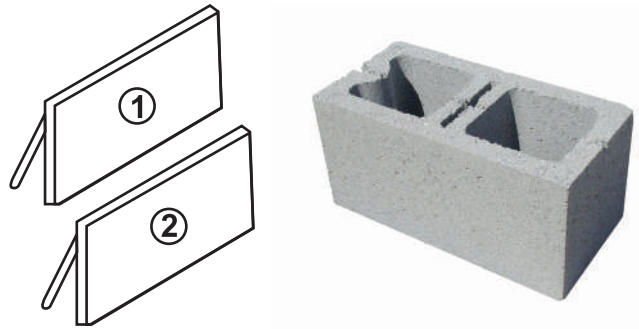

Fig. 4.2: Block mould



Fig. 4.3: Curing pipes



Fig. 4.4: Block pallet



Fig. 4.5: Block casting machine

## Precast cement concrete blocks construction

Precast cement concrete blocks are prepared by the following procedure.

### Manufacturing of concrete block

#### **Mould**

For manufacturing of concrete block, moulds are fabricated. These moulds should be made of mild steel plates. These moulds may be either fixed type (box with four side walls fixed at corners and top and bottom open) or split type.

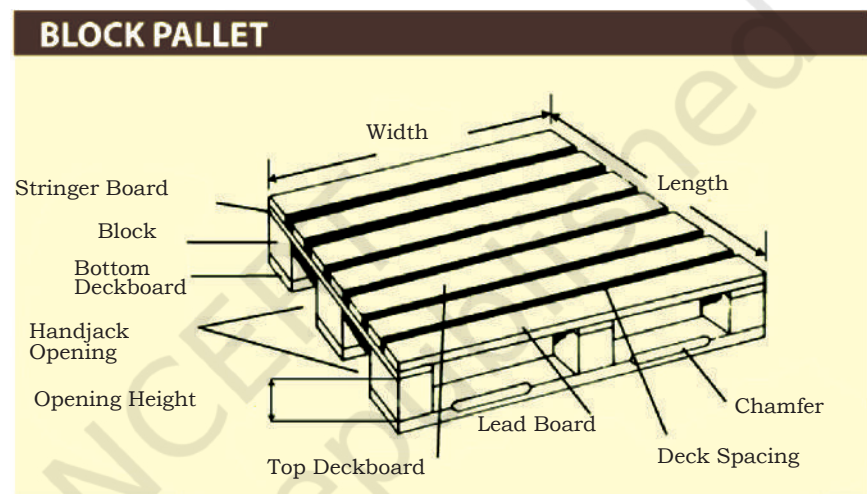

Fig. 4.6: Machinery used for precast concrete block making



Fig. 4.7: Block making machine

When the manual compaction of concrete is done, the mould may be fixed type or split type. Whereas when compression is done with surface vibrator, then split type moulds should be used.

After filling the mould with concrete, compaction is done for 5 to 10 minutes, demoulding should be done after 10 minutes of

compaction only. In case of fixed type of moulds, demoulding is done by opening one side handle and pressing down the blocks. Whereas, in case of split type moulds, the side of mould should be opened first and other sides and the partition plates shall be removed subsequently.

The block should be kept properly after demoulding till it gets hardened properly.



Fig. 4.8: Steps in moulding of concrete block

### **Proportion**

For preparation of mixture, standard proportion of cement, fine aggregate and coarse aggregate in the ratio of 1:5:10 is generally recommended. It may vary as per specific type of product. Proper compaction of concrete, water cement ratio, workability of the mixture and maximum strength are important aspects of mixture preparation.

### **Casting**

Concrete mixer should be used for mixture preparation. Water cement ratio should be minimum. After mixing the mixture, the concrete should be poured in moulds

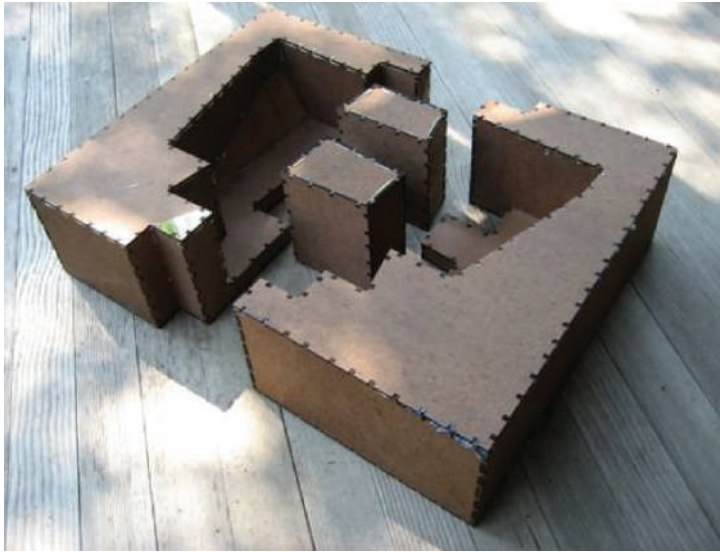

Fig. 4.9: Concrete Block Mould



Fig. 4.10: Curing Tank For Concrete Block

with a metal basket or a pot. Small immersion vibrator or table vibrator should be used for compaction of concrete. Demoulding should be done after 10 minutes as told earlier.

### **Curing**

In the process of curing, blocks are stored in the water tank. Curing of block is done for minimum 14 days to get good strength.

### **Drying**

Blocks are dried for two to four weeks after curing. Drying is done to reduce shrinkage, if any, in the block.

The blocks shall be allowed to complete their initial shrinkage before they are laid in a wall.

### **Dimensions**

As per construction requirements, blocks or units in different sizes and shapes are manufactured. Dimensions of concrete block may be kept length, height and width wise.

The nominal dimensions of concrete block is, as follows:

Length: 400, 500 or 600 mm

Height: 200 or 100 mm

Width: 50, 75, 100, 200, 250 or 300 mm in addition, block shall be manufactured in half lengths of 200, 250 or 300 mm to correspond to the full lengths.

### **Tolerances**

A provision for tolerance is also kept in length, height and width wise of unit. About +5 mm lengthwise, +3 mm for height and width should be kept as per tolerance while casting the product.

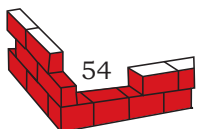



## **Density**

The mechanical properties of concrete are highly influenced by its density. A denser concrete generally provides higher strength and fewer amount of voids and porosity. Block density of  $1600 \text{ kg/m}^3$  must be ensured.

## **Laying of Precast Concrete Blocks to construct a Wall**

### **Construction of masonry**

Hollow bricks are used in foundation and basement masonry whereas solid bricks are used for top foundation for single storied buildings. Hollow blocks are filled with sand for stability. Solid concrete block is used in foundation, plint and basement wall in two storied buildings. When hollow bricks are used, then their hollow parts should be filled with cement concrete having proportion of 1:3:6 with 12.5 mm size aggregate.



Fig. 4.11: Concrete Block Wall

### **Wetting of Blocks**

As concrete blocks are prepared with curing process, they need not be wetted during laying in the walls. However in special condition, to prevent absorption of water from the mortar, top and side of the block may be little wetted.

### **Laying**

First course of blocks should be installed below floor level and inside the foundation trench. Then first line of blocks will be fixed on top with a layer of mortar mix. Mortar will be spreaded along the sides of the blocks. With the help of trowel, excess mortar should be removed. Repeat until the first course has been installed. Check the course with a level. Precast half length closer should be used instead of cutting from

full size blocks. Special care should be taken to avoid damaging of edges of block.

### ***Provision for Door and Window Frames***

For door and window opening, a course of solid concrete block must be placed. A 10 cm thick precast concrete may also be laid below windows. 20 cm provision should be done in concrete block laying below door and window.

### ***Intersecting Walls***

When two walls cross each other at a point, they are referred as intersecting walls. During the intersection of walls, a provision of 20 mm vertical spacing is left in the first wall. Courses of both intersecting walls are laid up at the same time.



*Fig. 4.12: Concrete block wall in house construction*

### ***Provisions for roof***

Solid blocks should be used below the roof slab. A layer of cement and coarse sand mortar, in standard proportion, should be placed at the top of course. It should be covered with a thick coat of white wash so that the movement of slab is not affected.

### ***Piers***

Solid blocks are used for making the top course of block in the pier. Hollow blocks are not recommended for isolated piers. Holdfast must be inserted into joints of masonry for better stability. Use of cement and coarse sand mortar in 1:3 proportion must be prepared while laying the blocks.

Various parts like holes, sleeves, chases, opening, etc., of desired size and shape should be developed in the masonry with special blocks. It should be used while fixing pipes, service lines, passage of water, etc.

### **Finishes**

The process of external wall plastering is known as Rendering. Rendering should be avoided when the walls are wet. Joints for plastering or pointing should be raked upto a depth of 12 mm. Joints on internal faces, should be raked for plastering. When the internal faces are not plastered, then the joints should be finished with flush or pointed flush as per the need.

### **Precautions during precast concrete construction**

#### **DOs**

1. For quality control, three blocks out of every 1000 may be tested for compressive strength.
2. Through stones should be provided at regular intervals of 1.5 meter height.
3. Natural bed of stone should be always perpendicular to the loading.
4. Mortar should be consumed within 30 minutes of adding water to the mortar mix.

#### **DON'Ts**

1. Fine sand should not be used for block production.
2. Wetting of blocks is not necessary, they should be laid dry. Only in hot weather, the blocks should be wetted on the surface to reduce their suction of moisture from the mortar.
3. Rounded stones should not be used for masonry.
4. Don't make holes in the masonry for scaffolding. Only double scaffolding should be used.
5. Bonding of the wall should not be filled with small stone pieces.

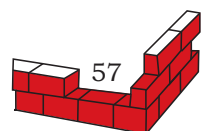

## Practical Exercise

1. Visit the precast concrete block construction site, observe the activities, then, prepare and submit a report of your observation.
2. Calculate the number of precast concrete blocks required to prepare a wall of 20cm thickness 4m height and 6m length.

## Check Your Progress

### A. Short Answer Questions

1. Give the advantages and disadvantages of precast concrete block.
2. Draw a neat diagram of the concrete block mould.
3. Mention the dimensions for precast concrete block.
4. Write down the procedure of laying concrete blocks in the construction of wall.
5. Why the precast concrete blocks are used in construction?

### B. Fill in the blanks

1. \_\_\_\_\_ is a construction product produced by casting concrete in a mould or form.
2. Cement mortar used in the construction of concrete block wall construction is of \_\_\_\_\_ ratio.
3. The top course of block in the pier shall be built in \_\_\_\_\_ blocks.
4. The concrete block is cured for \_\_\_\_\_ days.
5. \_\_\_\_\_ and \_\_\_\_\_ are carried out to check the quality of the block.

### C. Multiple Choice Questions

1. Precast concrete is a construction product produced by casting concrete in a \_\_\_\_\_.  
(a) reusable mould (b) plastic mould  
(c) sand mould (d) None of these
2. Block making machine is \_\_\_\_\_ operated.  
(a) manually (b) motor  
(c) electrically (d) All of the above
3. Curing of blocks should be done for minimum \_\_\_\_\_.  
(a) 07 days (b) 15 days  
(c) 28 days (d) 35 days

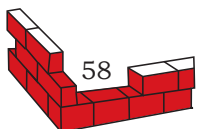

4. Ideal mixture for mix for concrete block is \_\_\_\_\_.
- (a) 1:4:8 (b) 1:5:10  
(c) 1:6:10 (d) 1:8:16
5. Maximum block density of hollow block is \_\_\_\_\_.
- (a) 1000 kg/m<sup>3</sup> (b) 1400 kg/m<sup>3</sup>  
(c) 1600 kg/m<sup>3</sup> (d) 2000 kg/m<sup>3</sup>

**D. Write a paragraph on the following**

1. The manufacturing process of precast concrete block.
2. The tools used in precast concrete block construction with the help of diagrams.



# Waterproofing Works for Structures using Cementitious Materials



171103CH05



Fig. 5.1: Standard practices for waterproofing

## IMPORTANCE OF WATERPROOFING IN A BUILDING

To prevent water seepage and rainwater penetrating in a building, treatment is given to check water entry in the wall, bathroom and roof. This treatment is known as waterproofing. Waterproofing increases the life of the structure.

During the construction of a structure or building, special care is taken to make it waterproof. Waterproofing is done in basements, podiums, damp areas, water-bodies, terraces, roofs and external walls. When a building shows signs of seepage in any of its areas, then waterproofing treatment is done. Waterproofing can be done during as well as after the construction.

## BASIC TERMINOLOGY USED IN WATERPROOFING

### Waterproofing

This is the process of making an object and structure in such a manner that no water seeps in. Water-resistant under specified conditions means that it remains relatively unaffected by water. This process can be used in wet and underwater conditions of specified depths.

### Bitumen Mastic

This is a multi-purpose trowel grade bituminous material for waterproofing, stopping, bedding, pointing and sealing. For waterproofing of roofs, bitumen mastic is used with material code number IS:3037-1965.

### Bonding Material

Any material that connects two substrates on application in layers is a bonding material. Roof surface requires a mixture, which is selected for local conditions of prevailing gradient and temperature, and it consists of blown bitumen conforming to the code number IS: 702-1961 or residual bitumen conforming to the code number IS 73-1961. When tested in accordance with IS: 1203-1958, the blown type bitumen penetration should be limited to 45.

### Reinforcement

Bitumen coated plain expanded metal lathing used for laying bitumen mastic to sloping or vertical surfaces.

### Underlay or Isolating Membrane

It is a layer of bitumen felt (sheet) conforming to IS: 1322-1965.

### Vapour Barrier

The function of a vapour barrier is to retard the migration of water.



Fig. 5.2: Execution process of waterproofing works

A vapour barrier can be as simple as a heavy gauge plastic sheet or an aluminium foil bonded to insulation sheets.

It consists of hessian based type 3 felt conforming to IS: 1322-1965 and with minimum overlaps of 100 and 75 mm at the end and the sides of strips of felt. It is also used as an isolating layer between the roof deck and insulating materials, which protect the insulation against the absorption and the effects of moisture from below.

## TOOLS AND EQUIPMENT USED FOR WATERPROOFING

- Brooms
- Brushes
- Buckets
- Caulking guns
- Chisels, including cold chisels
- Cutting blades
- Dumpy, laser and water levels
- Electric drills and screwdrivers
- Electric hammers
- Extension leads
- Fusion rollers
- Gas burners and torches
- Hammers
- Hoses
- Measuring tapes and rules
- Mixers and mixing apparatus
- Moisture meters
- Nylon rollers
- Wood floats
- Vacuum cleaners
- Plant, including:
  - Excavating equipment
  - High pressure water equipment
  - Pumps
  - Heat welders
  - Hot air welders
  - Impact drills
  - Pressure injection equipment
  - Compressors
  - Cartridge applications
  - Vacuum pumps
- Pressure rollers
- Scissors
- Seam probes
- Solvent applicators
- Spirit levels
- Straight edges
- Trowels

### Basic Levelling Tools used for Masonry

In construction work, level is the second most important tool after trowel. A good level is lightweight and absolutely straight and for getting better levels,

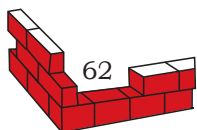



spirit level tool is used. The purpose of the level is to keep the work you are doing plumb (even high and low, or vertically and even straight across, or horizontally). The following are the important tools that are used for levelling.

### Spirit level

A good level has usually six vials, first two in the center and two at each end. In order to be straight or levelled, the bubble must line up between the two red or black lines. You might want to get a level that is at least 36" long while laying more than one block at a time.



Fig.5.3: Spirit Level

### Plumb bob

A plumb bob or plummet, is a weight, having a pointed tip on the bottom, which is suspended from a string and used as a vertical reference line, or plumb-line. It is essentially the vertical equivalent of a 'water level'.

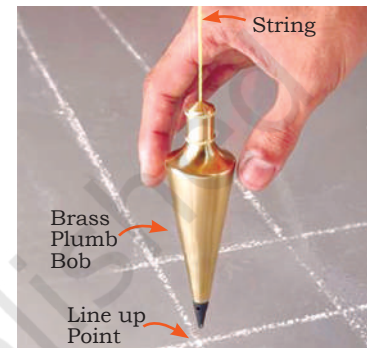

Fig. 5.4: Plumb Bob

### Water level

A water level is a device used for matching elevations of locations that are too far apart for a spirit level to span. The simplest water level is a section of clear tubing, partially filled with water.

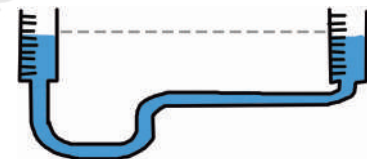

Fig. 5.5: Water Level

### Mason line

It is used to create straight lines and a level surface and this line will let you build walls without bulges or hollows. A mason's line is placed very close to the block that is being laid, but there is enough room to still permit you to swipe off the excess mortar without disturbing the line.



Fig. 5.6: Mason line

### Material Required for Waterproofing

- Cement
- Sand
- Metal

- Brick bats
- Waterproofing powder chemical
- Geruor Red colour
- Shahabad tiles
- G. I. Sockets



Fig. 5.7: Bitumen

## Waterproofing chemicals

### **Bitumen**

Limestone or sand is mixed with a filler component. Polymers are added to the bitumen such as APP (Atactic Polypropylene), a plastic additive that gives rigidity and tear resistance, or SBS (Styrene Butadiene Styrene), a rubber additive which gives more elastic benefits.

### **Base products**

Polyester, fiber glass, rag fiber (hessian) and paper are used as base products in waterproofing chemicals. These products are bought in the form of roll format and are pulled through the bitumen mixes on huge rollers. The base product becomes saturated in huge tanks by the tar like bitumen substance, thus creating a roll of waterproof material.

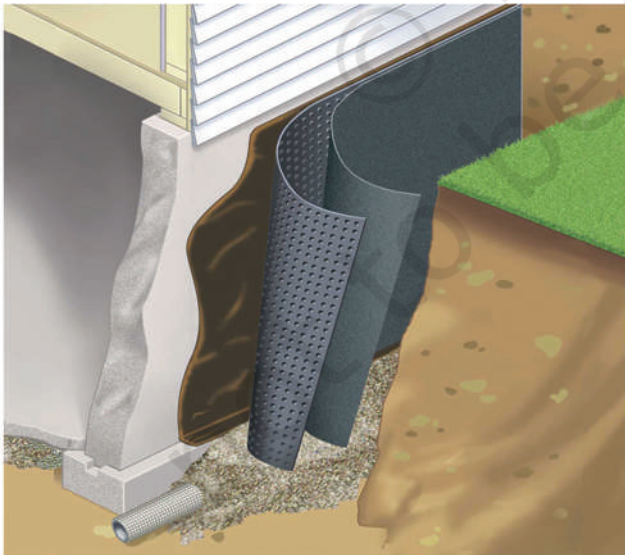

Fig. 5.8: Waterproofing membranes

## Waterproofing membranes

- In this waterproofing membrane system, it includes both negative and positive side waterproofing works.
- The positive side waterproofing systems are applied to the face of the element that is directly exposed to moisture, i.e. the exterior side.
- The negative side waterproofing systems are

applied to the surface of the element opposite to the surface which is exposed to moisture, i.e. the interior side. Positive systems are available in different types of materials and forms but negative systems are limited to cementitious systems.

## Waterproofing compounds

Different types of waterproofing compounds used for waterproofing works.

### **Wonder-seal**

It is an integral waterproofing compound used for plaster and concrete. It makes the concrete dense and cohesive and can be used with all types of cement. It is free from any sulphates and chlorides. Wonder-seal cement waterproofing compound is ideal for buildings, industrial constructions, reservoirs, sewers, swimming pools, cellars, etc. In these areas, impermeability is a must. It contains an active water repellent admixture which fills the pores in cement concrete or mortar and also overcomes the capillary absorption of moisture to prevent the passage of water. Proper ramming or the use of vibrator is strongly recommended for best results.

### **Crystal Sealer**

It is a cement based waterproofing compound that chemically reacts with moist cement based substrates. Crystal sealer forms insoluble crystals in the capillary tracts of the substrate permanently waterproofing the surface yet still allowing the surface to breathe.

- Various range of products for waterproofing and repairs are available for use in construction. This range includes Waterproofing Compounds, Repair Products, Tile Fixing Products, Sealants



Fig. 5.9: Spraying waterproofing material



Fig. 5.10: Waterproofing compounds

and Putties, Concrete Admixtures, Flooring Products and Grouts.

## **Water Based Exterior Wall Emulsion Paint Series**

Nowadays for new or old exterior surface of brickworks, plaster and concrete Water based exterior wall emulsion paint series are available in the market. Important features of these paints are dust proof, alkali fungus resistant, weathering resistant, strong adhesion, and long service life. These paints are characterised by model number like:

VB1200- Project Use Exterior Wall Emulsion Paint  
1900-Superfine Exterior Wall Emulsion Paint  
2900-Superfine Exterior Wall Emulsion Paint  
5900-Superfine Exterior Wall Emulsion Paint  
VH1001-High Glossy Exterior Wall Emulsion Paint  
V0000A-Elastic Exterior Wall Paint



*Fig. 5.11: Cementitious waterproofing*

## **Different Types of Waterproofing Methods**

### **Cementitious waterproofing**

It is the easiest method of waterproofing used in construction. The materials for cementitious waterproofing are easily available from the suppliers of masonry products, and they're easy to mix and apply.

This method is often used in the internal wet areas such as toilets. This method is usually a rigid or semi-flexible type waterproofing, but since it is used in internal areas such as toilets, it is not exposed to sunlight and weathering. Thus cementitious waterproofing does not go through contract and expansion process.

### **Application of cementitious waterproofing**

Cementitious waterproofing is used in the following type of structures:

- Water treatment plants
- Sewage treatment plants
- Bridges

- Dams
- Railway and Subway system
- Marine cargo ports and Docks
- River locks or Channels and Concrete dykes
- Parking structures and lots
- Tunnels

### Liquid waterproofing membrane method

Liquid membrane is a thin coating which usually consists of a primer coat and two coats of top coats which are applied by spray, roller, or trowel. It offers more flexibility than the cementitious type of waterproofing. The liquid cures into a rubbery coating on the wall. The elongation properties of the coating can reach as high as 280%. The durability of the waterproofing coating depends on the type of polymer that the manufacturer uses for making the liquid waterproofing.

Liquid waterproofing membrane can be spray-applied liquid membrane composed of polymer-modified asphalt. Polyurethane liquid membranes in separate grades for trowel, roller, or spray are also available from various manufacturers.



*Fig. 5.12: Liquid waterproofing*

### Bituminous coating waterproofing method

Bituminous coating is a type of coating used for waterproofing and flexible protective coating in accordance with its formulation and polymerisation grade. Its flexibility and protection against water can be influenced by the polymer grade as well as the reinforcement of fiber.

Bituminous coating is also called asphalt coating. The most common applications of bituminous coating include areas that are beneath screed wet. It is an excellent protective coating



*Fig.5.13: Bituminous Coating*

and waterproofing agent, especially on surfaces such as concrete foundations. Bituminous coating is made of bitumen based materials and it is not suitable to be exposed to sunlight. It becomes very brittle and fragile when long exposed to the sunlight unless it is modified with more flexible material such as polyurethane or acrylic based polymers. The flexibility of the finished products depends on the solid content of the polymer added to the bitumen.

### Bituminous membrane waterproofing method

Bituminous membrane waterproofing is a popular method used for low-sloped roofs due to their proven performance. Types of bituminous waterproofing membranes are torch-on membrane and self-adhesive membrane.

Self-adhesive compounds comprise asphalt, polymers and filler; additionally, certain resins and oils may be added to improve adhesion characteristics. The self-adhesive type has low shelf life as bonding properties of the membrane reduces with time.



Fig. 5.14: Bituminous Membrane Laying

Torch-on membranes have exposed and covered types. Exposed membrane often has mineral granular aggregate to withstand the wear and tear of the weathering. In the other types of membrane, the contractor needs to apply one protective screed to prevent the puncture of the membrane.



Fig. 5.15: Polyurethane Liquid Membrane

### Polyurethane liquid membrane waterproofing method

Polyurethane liquid membrane method of waterproofing is used for the flat roof area and exposed to weathering. This waterproofing method is expensive.

Polyurethane liquid membrane can offer higher flexibility. Polyurethane is very sensitive to the moisture content present, therefore before application, one has to be very careful evaluating the moisture content of the concrete slab, otherwise

peeling or de-bonding of membranes may happen after some time.

### Brick Bat coba waterproofing method

Brick bat coba waterproofing method helps to seal the cracks and water leakages and hides the untidy marks. It also provides aesthetically appealing coverage using china mosaic tiles.

The steps of brick bat coba waterproofing method are as follows:

1. First, the debris is removed and the whole surface is cleaned.
2. Then apply raddo of water, chemical and cement on the surface.
3. Lastly, the china mosaic tiles are put and fixed.



Fig. 5.16: Brick Bat coba waterproofing

### Poly acrylic chemical coating waterproofing

It is one of the superior levels of waterproofing solutions. First, the solution of poly acrylic chemical is prepared to seal the breakage or leakage on the wall and terrace, which gives a strong waterproof base as well as protect and preserve the strength of any structure. This is done by a highly trained professional team. You need to make sure that high-quality products are used in the procedure.

In this type of waterproofing you need to clean the place before closing the cracks with poly acrylic chemical coating. Then put two coats of poly acrylic chemical with white cement on the surface.



Fig. 5.17: Poly Acrylic chemical coating waterproofing

## Pre-monsoon roof repairing

This method is ideal for buildings and structures that are already having leakage or damage as well as for new structures to avoid leakage in the future. This process helps in maintaining the life and quality of the building and it ensures that there is no damage to the building because of the rainfall. You can try this method once in a year in a building.



Fig. 5.18: Pre-monsoon roof repairing

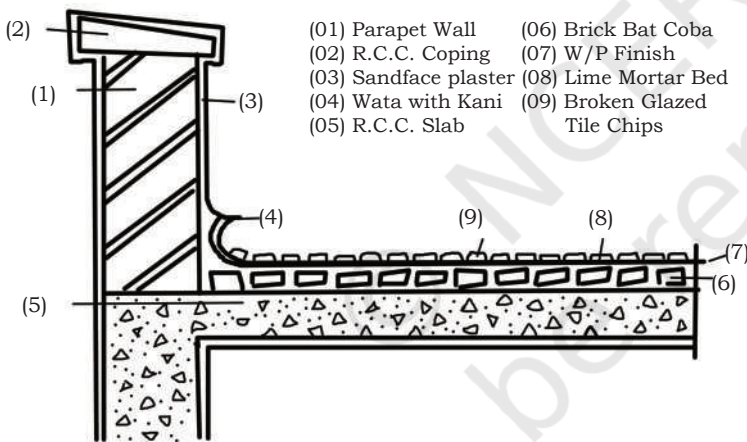

Fig. 5.19: China mosaic tile waterproofing

## China Mosaic Tile Waterproofing

There are many construction materials which are not highly resistant to moisture. Therefore, a very important aspect of any construction process is to ensure the protection of materials. The modern market of construction materials is represented by various types of

waterproofing materials, which are designed to effectively protect the foundation, roof, walls and floor structures from the damaging effect of groundwater moisture or precipitation.

## Rigid waterproofing

It comprises waterproof dense concrete, shotcrete, metal and sand-cement plaster waterproofing, which is done by hand or by using compressed air.



Polymeric or metal sheets are used for making stiff sheet waterproofing. They are fastened to the building envelope by the means of anchors, screws, glue, pins or by welding.

### Paintable waterproofing

It is a waterproof film which is formed by coating the surface with liquid or plastic materials, such as bitumen, mastic or special paint and varnish, which have corresponding properties, i.e., resistance to moisture. Modern waterproofing paints or varnishes have synthetic resins and plastics, which also create excellent protection against moisture.

### Lining waterproofing

This type of waterproofing combines two different types—paintable protection and lining waterproofing. It has greater efficiency and perfectly protects brick, concrete, metal and other surfaces. Lining Waterproofing involves coating the surface with roll or sheet material. Roofing felt is the best example of such coating. Nowadays it is also possible to use extruded polystyrene, which is glued to the bitumen mastic by hot or cold application method.

### Waterproofing with wall putty

This type of waterproofing consists of different liquid compositions of mastics and mortars (mud) to create continuous seamless waterproofing layers. This is a durable waterproofing method often used in construction and trimming, as it is resistant to physical, mechanical and chemical influences. It does not crack under the influence of weather conditions or differential house settlement and it is also sufficiently elastic.

### Plaster waterproofing

Plaster waterproofing can be divided into three categories on the basis of material used.

1. Cement plaster, it is applied in a layer of 5 to 40 mm to the surface.
2. Asphalt plaster, which is applied in several layers, each one of them being 4 mm thick. The

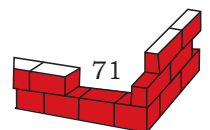

coating represents protection made of hot or cold mastics.

3. Molded asphalt waterproofing—it is a solution of hot mastic, which is poured into the cavity between the protective wall and the insulated surface.



Fig. 5.20: Penetrating waterproofing

### Penetrating waterproofing

This kind of waterproofing provides good water resistance to concrete structures. It can be applied at the beginning of the building process and at the final stage. Compositions deeply penetrate into the surface with a porous structure.

Also, this waterproofing has the properties of prevention from corrosive processes in the reinforcing structures. The penetrating protection compositions can withstand chemical attack and significantly increase resistance of the surface.

### Process of Performing Various Visual Checks on Materials and Surface for Waterproofing

1. Materials used should be of standard specification and manufacturing quality.
2. Materials to be used on various surfaces should match the properties of waterproofing materials.
3. Surface has to be cleaned with water and the debris stuck on surface should be cleaned thoroughly.
4. Relevant tools are used for the application of waterproofing materials on different surfaces.

## **Different Surface Preparation Method Prior to Waterproofing such as Prime Coating**

A prime coat is an application of a low viscosity asphalt to a granular base in preparation for an initial layer (or surface course layer) of asphalt. The purpose of the prime coat is— to coat and bond loose material particles on the surface of the base, to harden or toughen the base surface to provide a work platform for construction equipment, to plug capillary voids in the base course surface to prevent migration of moisture, and to provide adhesion between the base course and succeeding asphalt course. After applying the prime coat, it must cure for a minimum of 48–72 hours before asphalt is placed, assuring no rain in the forecast.

At one time, prime coat was thought to be an essential the element of good pavement construction. However, in the recent years many engineers have eliminated the use of prime coat in their specifications, especially when asphalt layer(s) is 04 inches or more in thickness. Also, it is not used even when the surface thickness has been as thin as 02 inches.

## **Filling holes or depressions by cementitious material**

One of the easiest waterproofing materials to fill the holes or depressions is called cementitious material. They are readily available from the suppliers of masonry products, also they are easy to be mixed and applied. One can get a stronger bonding and durable coating by using this material.

## **Hacking of existing RCC surface**

Hacking means removing the surface or outer layer, whether it is of paint, cement, tile, etc.

### **Procedure**

- The person supervising the hacking must make a detailed study of the structure to be hacked and implement a hacking plan that will ensure that the sequence of hacking does not possess risks and hazards both to the operator and the workers.

- Explain the risks and hazards involved and the basis of safety measures to be taken to address any potential hazards or danger that may arise, and provide standing supervision to all the workers.
- Barricades should be put prior to the beginning of operations and warning sign should be displayed.
- It should be ensured that no person shall enter or work near the hacking area.
- When necessary, provide direct sufficient amount of water at breaking point to reduce dust. From protection point of view, workers must wear the basic Personal Protective Equipment (PPE), protective gloves, ear plug, dust mask and safety goggles.

### Cleansing free of dust

To remove loose dust, the surface is washed with normal water. A heavy-duty, wet and dry vacuum can be used for getting water and dust off from the surface. After the floor dries, a concrete surface treatment containing magnesium fluosilicate, zinc fluosilicate or sodium silicate is applied. These preparations form a chemical bond with the cement on the surface. This treatment is usually applied in two or three coats, letting the surface dry between each application.

### Priming or sealing of surface

Sealing is particularly important in concrete construction where construction joints need to be finished in a day. They occur when a structure is built of successive concrete sections. In new buildings, construction joints are sealed with suitable hydrophilic water bars, metal water stops or joint sealing strips.

For the post-construction sealing of damaged construction joints, the injection technique is used. Here, boreholes are drilled following a set pattern whereby the drilling axis should cross the joint directly in its middle. The holes are then equipped with injection

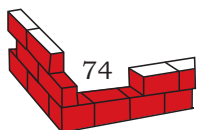

lances through which the grouting material is injected under pressure into the joint.

During the injection process, first the injection channel is filled followed by the joint and later the cracks and gaps in the area closest to the joint. The grout then forces its way into large pores and cavities and later on during the injection process, penetrates the capillary pores. Injection process continues until counter pressure has built up in the structure, and grout discharge is evident in the area of the joint, or from the neighbouring injection lance.

## Removing sharp edges

### **Step 1**

The surface near the damaged area is cleaned by removing any loose material such as dirt, oil, or grease and unsound or flaking concrete.

**Tip:** Unsound or flaking concrete can be removed by using a hammer and chisel or with a masonry grinding disk and portable drill.

### **Step 2**

The surface is scrubbed and cleaned with a stiff bristle brush to repair the area.

### **Step 3**

After cleaning, the repairing area is rinsed thoroughly.

Following process is applied to repair concrete edges after removing sharp edges:

### **Step 4**

Mix the quick-setting cement using a margin trowel by adding five parts of cement and one part QUIKRETE (Acrylic Fortifier) until a lump-free, putty consistency is achieved. It is important not to add more water or Acrylic Fortifier after the material has begun to set.

**Tip:** If the mix is too wet, adding additional Quick-Setting Cement and mixing thoroughly will help reach the desired consistency; if the mix is too dry then adding small amounts of Acrylic Fortifier works.

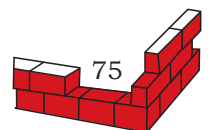

### **Step 5**

The repair area is then dampened with water to saturate the surface (standing water, if any, is removed).

### **Step 6**

A masonry brush is used to apply a thin coating of the Quick-setting Cement and Acrylic Fortifier mixture on the surface.

### **Step 7**

Using a margin trowel, the cement is pressed into the repair area using firm trowel pressure.

### **Step 8**

Building and sculpting the Quick-setting Cement is continued so that the surface of the repair is above the surrounding concrete.

### **Step 9**

Once the patch has become thumb-print hard in about 5 to 10 minutes, the edge of a margin trowel is used to mould and shape the repair to match the contour of the surrounding concrete.

## **Procedure for Checking Water Leakage in Waterproofed Surface**

### **Testing of waterproofing**

- Waterproofing of slabs is tested by ponding the surface with water to a depth of 25 mm for 24 hours or longer.
- The waterproofing is considered to be satisfactory, if no leaks or damp patches show on the soffit.
- IS: 2645:2003—Specification of Integral Waterproofing Compounds for cement mortar and concrete provides specifications for this waterproofing.

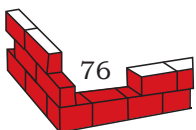

## Procedure for Carrying Out Horizontal and Vertical Alignment of Waterproofed Course

### Surface Condition

The waterproofing membrane is kept free from sharp projections, dirt, and dust. If water testing is desired, then it is made prior to placing in protection course.

**Tip:** Protection course is applied at the end of each day's waterproofing to both horizontal and vertical surfaces.

### Horizontal Surfaces

Protection course is installed over the waterproofing membrane as soon as possible from the membrane applicator or manufacturer. Protection course sheets are butted together and then cut to fit all the intersecting surfaces and protrusions.

### Vertical Surfaces

For damp-proofed or waterproofed vertical walls to receive backfill, Protection Course are butt jointed and, if necessary, temporarily held in place while backfilling is done.

### Backfilling

Backfilling against vertical walls is done immediately using care and caution to avoid damaging the waterproofing. Backfill material is not dropped against protection course in such a manner that it could drag the sheet down as the backfill drops. In horizontal applications, the waterproofing and protection course is installed just prior to the installation of the draining or wearing surface.

### Precautions

An approved adhesive must be used when protection course is adhered to a waterproofing membrane. Where taped joints are desired with tape set in hot asphalt, consult a membrane manufacturer. Protection course is shipped on pallets with the polyethylene anti-stick sheet on the top or exposed

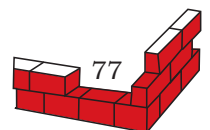

side, and it is stored on pallets and placed on a level surface.

### Procedure for Transferring Levels on Floor for Maintaining the Desired Slope

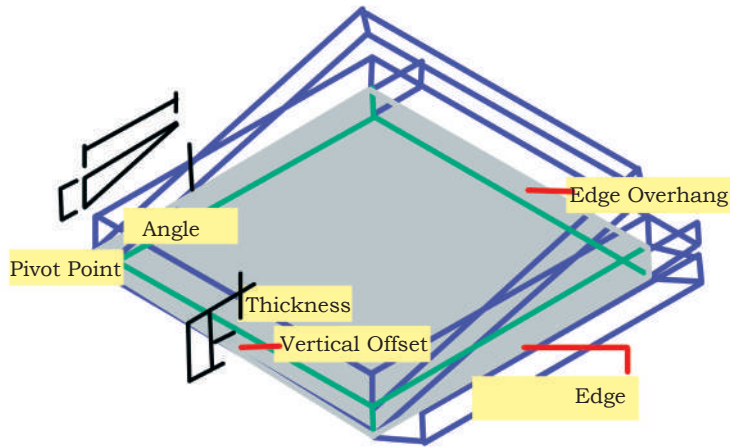

Fig. 5.21: Maintaining desired slope

First transfer the lines from temporary bench using strings or water level to column or plinth level. Mark the signage of bench on each corner of the room or building.

According to defined gradient suggested in the drawing, we can easily maintain the slopes on floors for various purposes like drain, etc.

### Procedure for Carrying Out Brick Bat Coba Waterproofing

#### Waterproofing by brick bat coba

In brick bat coba, roof slabs constructed either by RC or RCC, need insulation for thermal comfort and waterproofing treatment to prevent leakage of water. Both these requirements are effectively fulfilled by brick bat coba treatment, the details of which are given below: The existing treatment and coating is removed and the surface is cleaned by hard wire brush and also washed with water. The surface is made free from any oil, grease, dust and such material. Expansion joints are treated on the basis of standard practice.

All non-structural cracks more than 0.5 mm wide and construction joints, if any, are cut in 'V' shape, cleaned with wire brush and washed, and then the cracks are filled by polymer modified cement or mortar using acrylic polymer, with the additional cement slurry mix spread upon cleaned SSD roof surface. Over this 15 mm thick cement, sand mortar that is mixed in the ratio of 1:4 is laid with water proofer.

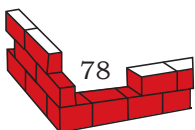



## Brick bat laying

A layer of brick bats, which have been soaked overnight in water, is laid on the green mortar, having an average thickness of about 110 mm, about 70 mm near rainwater pipe and 150 mm at ridge. The gaps between the brick bats are generally kept between 15 and 20 mm; these gaps are filled with cement sand mortar in the ratio of 1:4 with water-proofer. In hot and dry weather, the surface is covered with wet gunny bags immediately after finishing. Curing starts the next day and continued for seven days.

## Finishing layer

The top surface is then given a smooth finish with 20 mm thick cement sand mortar in the ratio of 1:4, admixed with a water-proofer. All liquid admixtures are mixed with the mixing water. The surface when green is marked with 300 mm false squares. Curing is to be done by ponding.

## Methods and Techniques to Protect Waterproofing as per the Site Requirements

- (a) If the roofs are made for home or for any machinery purposes, it requires periodic maintenance or cleaning, it is recommended to produce walkways using concrete pavements laid on supports, or a concrete screed, to give all the operators a safe access route to follow. Before installing walkways, a suitable separating layer must be placed between the membrane and the in-situ concrete deck.
- (b) Special footwear is worn when walking directly on the waterproofing membrane, both for the safety of the person and to avoid damaging the membrane.
- (c) If it is needed to walk on the waterproofing membranes, the hottest part of the day in summer is avoided and similarly, the coldest part of the day in winter. To avoid putting membranes under particularly high mechanical stress, footwear with very thick soles (cleated sole footwear) is used, instead

of the use of footwear with smooth soles is recommended. Prior to using cleated sole footwear, a check is done that no fine gravel or other abrasive material has accidentally stuck to or become lodged in the sole before walking on the waterproofing membrane to avoid the risk of scraping or piercing the membrane in question.

- (d) Extreme care is taken to avoid the risk of slipping when accessing a roof during rain or if the roof has pooling water or is icy.
- (e) Utmost care is taken to never place anything heavy or sharp directly on the waterproofing membrane, unless a suitable protective surface has been prepared first to set the object down on and distribute the load (such as wooden planks or other suitable devices).

### Application of waterproofing

Waterproofing is done in various parts of the building which includes:

1. Water Closet (W.C.)
2. Bathrooms
3. Terrace
4. Roofs and *Chajjas*
5. Basement, swimming pools and underground ducts
6. Underground and overhead water tanks
7. R.C.C. Roof slab

### **Water Closet (W.C.) waterproofing**

(A) *Following pre-work is completed before beginning the waterproofing work*

1. Plastering of the internal wall is completed leaving a margin of 18" from the final floor level of W.C. unit.
2. Grooving work for concealed G.I. piping or electrical conduit piping in W.C. is completed.
3. The work of making holes for connecting *nahani* trap, P-trap, floor trap, etc., to external drainage line in the external wall is completed.

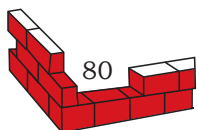

4. All the debris is removed from the floor of W.C.
5. W.C. is cleaned thoroughly with water.
6. Marking is done on the walls for setting up of trap level.
7. Sufficient amount of water is used for cleaning of W.C.

*(B) Base Coat for W.C. waterproofing*

1. A thick cement mortar base coat with 25 mm to 40 mm thickness in proportion of 1:4 is provided in W.C.
2. The above mentioned coat is provided with a slope of 1:100 from entrance door towards the water escape pipe.
3. Similarly, this basecoat is provided on all the walls up to 45 cm height above toilet finished floor level.
4. Water is filled up to the height of base for minimum four days. The purpose of filling water is for curing and testing of waterproofing.
5. It is checked and tested after four days.

*(C) Topping Coat for W.C. waterproofing*

- The coating of brick bat coat is done with 1:4 cement mortar mixed with waterproofing material. With the help of metal float, finishing is done with cement slurry.
- For better bonding, surface of the side wall is roughened with wire brush up to 45 cm above W.C. floor level. As the thickness of this material is very thin, it will not affect anything.
- After the final coat, water is filled up to 7.5 cm depth in the water closet for minimum seven days for better curing.

**Components of Topping Coat for W.C. Waterproofing**

1. Firstcoat W/P (*tapani*)
2. Water escape pipe

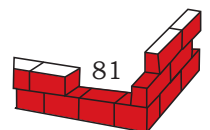

Polyflex WP is a flexible waterproof brush or roller applied on cementitious coating seepage of water, salts and pollutants, whilst still allowing the substrate to breathe.

3. Wire mesh and filter media
4. 'P' trap
5. Brick bat coba coat
6. Final coat W/P (Topping coat)
7. W/C pan
8. Filling material
9. Top finishing by mortar
10. Mortar bed
11. Glazed tile flooring

### **Bathroom waterproofing**

#### *(A) Preparation of bathroom waterproofing*

- After completing the plastering work of internal wall, a margin of 18" from the final floor level of the bathroom is kept.
- The grooving work for concealed G.I. and electrical conduit piping in the bathroom is completed.
- The holes for connecting *nahani* trap, P-trap, floor trap, etc., to the external drainage line in external wall are made.
- All the debris from the floor of the bathroom is removed.
- The bathroom is cleaned thoroughly with water.
- The level is marked in red on the walls for setting up of the trap level.

*Nahani* trap is provided in the floor to collect waste water from washbasin, shower, sink and bathroom, etc. These are available in cast iron or UPVC material and have removable grafting (*jali*) on the top of the trap.

#### *(B) Base coat for bathroom waterproofing*

1. Provide cement mortar base coat of 15 mm to 25 mm thickness in proportion of 1:4 in the bathroom.

This coat is prepared with a slope of 1:100 from entrance door to water escape pipe.

2. The base coat will cover all the walls up to the outer face wall line at the entrance door and the bottom portion of the *nahani* trap connection hole made in the wall.

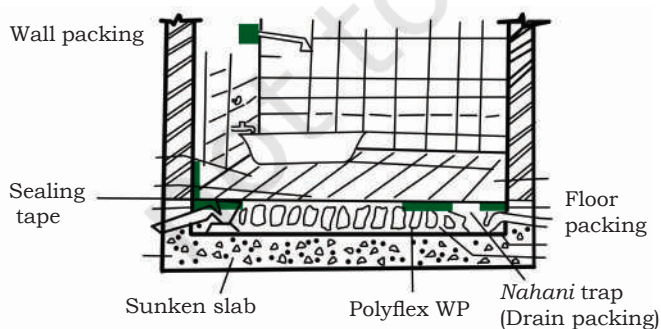

Fig. 5.22: Base coat for bathroom waterproofing

3. Water is filled up to the height of base for minimum four days. The purpose of filling water is for curing and testing of waterproofing quality.
4. Fix the *nahani* trap and water escape pipe or leakage drain pip over the base coat. Also all the concealed pipes such as G.I. outlet pipe for wash basin, etc., are laid.

### **Terrace waterproofing**

It is a tricky problem in building construction, mainly because the surfaces are flat. This means that water cannot run off the structure quickly, and will move slowly or pool above the surface, creating opportunities for leakage.

Terrace waterproofing is able to resist leakage during heavy rainfall. It also provides insulation against heat loss during summers and winters and avoids humidity.

In addition, these flat surfaces require sumps or collection pits for water to flow into before entering the vertical drainage pipes, which could be a source of leaks.

The best way to waterproof a flat terrace is to use a waterproofing coating. This is a thin layer of waterproof material that is continuous, and offers no path for water to enter the structure. The membrane is laid on top of the structural slab. On top of the membrane, a filler material is laid. The filler material is necessary to give a slope to the finish of the terrace. This slope runs towards the drainage outlets.

### **Roof and Chajjas (awnings) waterproofing method**

1. Wash the roof surface making it dust free.
2. Fill all the visible cracks by way of specially prepared silicone crack filler.
3. Apply the first coat for filling the invisible cracks and small holes with diluted silicone.
4. Apply the second and third coat of silicone based cement waterproofing to strengthen the surface.

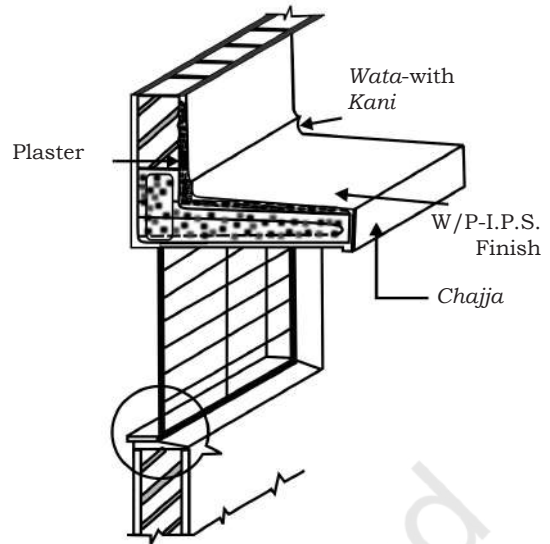

Fig. 5.23: Terrace and chhajja waterproofing

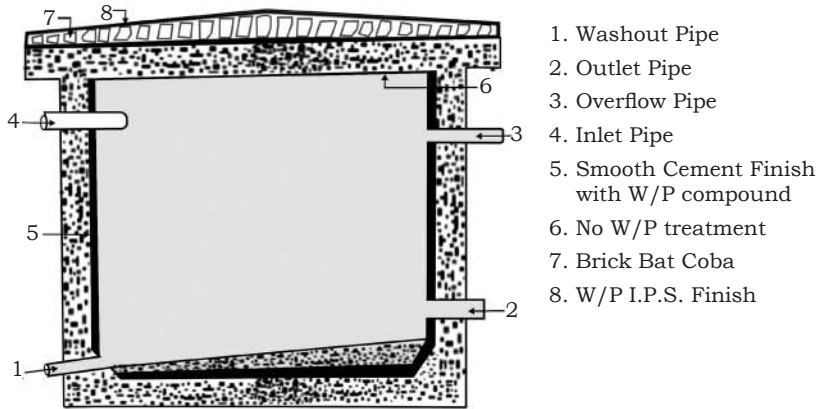

Fig. 5.24: Overhead tank waterproofing

1. Washout Pipe
  2. Outlet Pipe
  3. Overflow Pipe
  4. Inlet Pipe
  5. Smooth Cement Finish with W/P compound
  6. No W/P treatment
  7. Brick Bat Coba
  8. W/P I.P.S. Finish
5. Apply the fourth (final) coat of silicone based cement waterproofing.

Clean the top of the *chajja* and chisel extra mortar, if any.

- Apply thick cement slurry over the top of the *chajja*.
- Apply 1:1.5:3 screen coat.

- Make rounding at the junction of *chajja* and wall of the building.
- Cure this coat for seven days.
- Apply a finishing coat with C.M. 1:4 with a waterproofing compound.
- Cure the waterproofing for atleast seven days.

The final layer is the finish layer. This may be a tile, or a stone, or any material that can withstand outdoor conditions. The finish and the filler layers themselves do not contribute to waterproofing.

### **Basement, swimming pools and underground ducts**

For basement, swimming pools and underground ducts such as lift pits, the waterproofing has to withstand the water pressure in addition to its basic stress.

#### *Work procedure*

- Carry out the work of PCC bed and provide a cement mix 1:4 base coat with waterproofing compound, and above this fix rough Shahabad tiles.
- Maintain the break joint pattern while fixing the tile for base.
- After fixing the tiles, grout the joints with cement slurry completely.
- Apply a jointless layer of cement mortar 1:3 25mm thick and cure it for seven days.

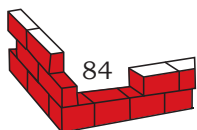

- For basement, provision of gutter and sump is made in PCC itself and Shahabad base is also prepared in the same way. The gutter is given proper slope towards the sump. This is done as a preventive measure against occasional entry of rain water into the basement.
- After curing, provide the final jointless waterproof plaster coat in cement mortar 1:4 over the rough shahabad tiles.

### **Overhead tank waterproofing**

Chisel the extra concrete in the tank, particularly in the corners around the chambers. Clean the entire tank, along with the bottom slab and side walls and throw away the debris. Allow the cement slurry to penetrate all the holes and cracks of the bottom slab. Check the hacking of vertical walls from inside for better bonding with waterproofing.

### **Waterproofing of R.C.C. roof slab**

The given steps are followed for waterproofing of the sloping terrace or *chajja*:

1. First, the surface of the sloping terrace or *chajja* is cleaned.
2. After that thick cement slurry is applied over the surface of the slab and then 1: 1½: 3 metal screen coat is applied.
3. This coat is protected for at least seven days by putting wet gunny bags on it.
4. Over this coat, a finishing coat with cement sand mortar in the ratio of 1:4 and waterproofing compound is applied as per the design.
5. Finally, the cement slurry with the waterproofing compound is applied and then colour pigments such as red, green, etc., are added.

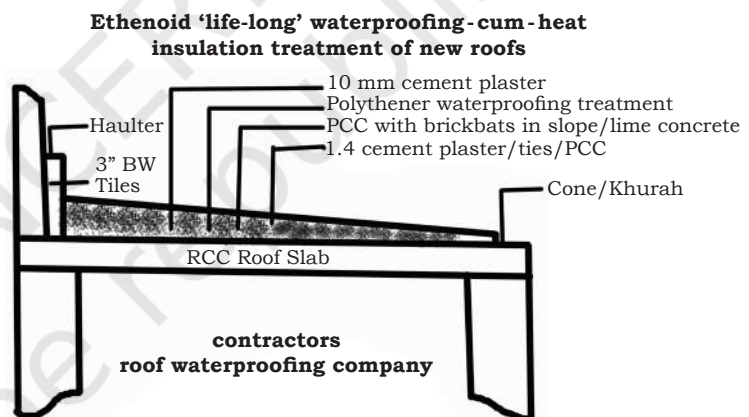

Fig. 5.25: Waterproofing of R.C.C. Roof Slab

6. On the second day, an edge is made between the parapet wall and sloping slab.
7. This waterproofing is cured for fifteen days with wet gunny bags spread over it.

### Check Your Progress

#### A. Answer the following

1. What is meant by waterproofing?
2. What are the different types of waterproofing?
3. Give the cement mortar mix proportions used for waterproofing works.
4. Enlist the surface preparation methods prior to waterproofing works.
5. How cementitious waterproofing course is laid?
6. Explain the method of brick bat coba waterproofing for RCC terrace roof.
7. Name any three types of waterproofing compounds used in waterproofing works.

#### B. Fill in the blanks

1. Wonder-seal is an integral \_\_\_\_\_ compound for plaster and concrete.
2. Brick bat waterproofing helps seal the \_\_\_\_\_ and \_\_\_\_\_ leakages.
3. Cementitious materials are probably the \_\_\_\_\_ waterproofing materials to fill the holes or depressions.
4. All existing treatment, coatings on roof slab top is to be removed and surface cleaned by a \_\_\_\_\_ and washed with water.
5. Bituminous membrane waterproofing method is used for \_\_\_\_\_ sloped roofs due to their proven performance.

#### C. Multiple choice questions

1. After stopping the leakage of the base slab, provide \_\_\_\_\_ mm to \_\_\_\_\_ mm thick cement mortar base coat in proportion of (1:4).
 

(a) 25 to 40	(b) 25 to 50
(c) 30 to 40	(d) 40 to 25
2. Tools required for waterproofing work are \_\_\_\_\_.
 

(a) Trowel	(b) Wooden float
(c) Plumb bob	(d) All of these
3. Bituminous membrane waterproofing is a popular method used for \_\_\_\_\_ roofs.
 

(a) low-sloped	(b) high-sloped
(c) medium-sloped	(d) None of these

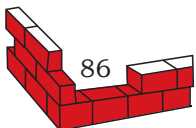



4. Chemical attack can occur because concrete is\_\_\_\_\_.
- |              |                   |
|--------------|-------------------|
| (a) alkaline | (b) acidic        |
| (c) hydrant  | (d) less reactive |
5. Concrete is very strong in compression but relatively weak in\_\_\_\_\_.
- |                 |                   |
|-----------------|-------------------|
| (a) elasticity  | (b) tension       |
| (c) flexibility | (d) None of these |

© NCERT  
not to be republished

## Answer Key

### Unit 1: Stone Masonry

#### B. Fill in the blanks

- |                     |              |
|---------------------|--------------|
| 1. mortar           | 2. dowels    |
| 3. common, ordinary | 4. irregular |
| 5. construction     | 6. two       |

#### C. Multiple choice questions

- |      |      |      |      |      |
|------|------|------|------|------|
| 1. c | 2. d | 3. a | 4. c | 5. c |
|------|------|------|------|------|

### Unit 2: Brick Masonry

#### B. Fill in the blanks

- |                    |                          |
|--------------------|--------------------------|
| 1. course          | 2. Header                |
| 3. moulding        | 4. lifting and spreading |
| 5. verticality     | 6. bricks                |
| 7. alignment, wall | 8. Header                |

#### C. Multiple choice questions

- |      |      |      |      |      |
|------|------|------|------|------|
| 1. a | 2. b | 3. b | 4. a | 5. b |
|------|------|------|------|------|

### Unit 3: Plastering Work

#### B. Fill in the blanks

- |            |         |          |            |
|------------|---------|----------|------------|
| 1. plaster | 2. sand | 3. 10 mm | 4. peeling |
| 5. brush   |         |          |            |

#### C. Multiple choice questions

- |      |      |      |      |      |
|------|------|------|------|------|
| 1. a | 2. a | 3. b | 4. a | 5. b |
|------|------|------|------|------|

### Unit 4: Precast Block Masonry

#### B. Fill in the blanks

- |                                |        |
|--------------------------------|--------|
| 1. Precast concrete block      | 2. 1:3 |
| 3. Solid                       | 4. 14  |
| 5. Field test, Laboratory test |        |

#### C. Multiple choice questions

- |      |      |      |      |      |
|------|------|------|------|------|
| 1. a | 2. d | 3. c | 4. b | 5. c |
|------|------|------|------|------|

### Unit 5: Waterproofing Works for Structures using Cementitious Materials

#### B. Fill in the blanks

- |                      |                    |
|----------------------|--------------------|
| 1. waterproofing     | 2. cracks, water   |
| 3. easiest available | 4. hard wire brush |
| 5. low               |                    |

#### C. Multiple choice questions

- |      |      |      |      |      |
|------|------|------|------|------|
| 1. a | 2. d | 3. a | 4. a | 5. b |
|------|------|------|------|------|

## Glossary

**Abutment:** a structure built to support the lateral pressure of an arch or span, e.g. at the ends of a bridge.

**Abutment:** a structure built to support the lateral pressure of an arch or span.

**Ashlar:** masonry made of large square-cut stones, used as a facing on walls of brick or stone rubble.

**Break water:** refers to a wall built out into the sea to protect the shore or harbour from the force of waves.

**Brick bat:** refers to the broken pieces of bricks.

**Brick bats:** is defined as the cut portion of a brick

**Bridge piers:** refers to structures used for supporting a bridge, embedded into the ground surface or into water under the bridge.

**Ballast:** is a material that is used to provide stability to a structure.

**Bed:** is the mortar upon which a brick is laid.

**Cleated:** a strip of wood or iron used to strengthen or support the surface to which it is attached.

**Deliquescent:** is the process by which a substance absorbs moisture from the atmosphere until it dissolves in the absorbed water and forms a solution

**Gneiss:** is a metamorphic rock with a banded or foliated structure, typically coarse-grained and consisting mainly of feldspar, quartz, and mica.

**Kiln dust (CKD):** is a fine, powdery material, portions of which contain some reactive calcium oxide, depending on the location within the dust collection system, the type of operation, the dust collection facility, and the type of fuel used. Kiln dust may be produced from cement or lime industry also.

**Lances:** a piece of glass or other transparent material with curved sides for concentrating or dispensing light rays.

**Mortises:** a rectangular hole in a piece of wood, stone, etc. into which another piece is fixed.

**Plinth:** base course of a building

**Pier:** is a solid support designed to sustain vertical pressure.

**Ponding:** refers to the act of pooling of unwanted water on a flat roof or road.

**Pumice:** is a very light weight, porous and abrasive material and it has been used for centuries in the construction and beauty industry as well as in early medicine.

**Sandstone:** is a stone that is formed of grains of sand tightly pressed together, used in building construction.

**Screeds:** A strip of wood, plaster, or metal placed on a wall or pavement as a guide for the even application of plaster or concrete.

**Spalling:** is the result of water entering brick, concrete, or natural stone.

**Sump:** is a pit or low space that often collects undesirable liquids such as water or chemicals.

**Trowel:** is a small tool with a flat blade used in building construction for spreading cement or plaster.

© NCERT  
not to be republished

