

Automotive Service Technician

(Job Role)

Qualification Pack: Ref. Id. ASC/Q1401

Sector: Automotive

Textbook for Class IX



17969

विद्यया ऽ मृतमश्नुते



एन सी ई आर टी
NCERT

राष्ट्रीय शैक्षिक अनुसंधान और प्रशिक्षण परिषद्
NATIONAL COUNCIL OF EDUCATIONAL RESEARCH AND TRAINING

ISBN 978-93-5292-123-2

First Edition

March 2019 Phalguna 1940

PD 5T SU

© **National Council of Educational
Research and Training, 2019**

₹ **200.00**

Printed on 80 GSM paper with NCERT
watermark

Published at the Publication Division
by the Secretary, National Council of
Educational Research and Training,
Sri Aurobindo Marg, New Delhi 110016
and printed at Gita Offset Printers (P.)
Ltd., C-90 & C-86, Okhla Industrial Area,
Phase-I, New Delhi - 110020

ALL RIGHTS RESERVED

- ❑ No part of this publication may be reproduced, stored in a retrieval system or transmitted, in any form or by any means, electronic, mechanical, photocopying, recording or otherwise without the prior permission of the publisher.
- ❑ This book is sold subject to the condition that it shall not, by way of trade, be lent, re-sold, hired out or otherwise disposed of without the publisher's consent, in any form of binding or cover other than that in which it is published.
- ❑ The correct price of this publication is the price printed on this page, Any revised price indicated by a rubber stamp or by a sticker or by any other means is incorrect and should be unacceptable.

OFFICES OF THE PUBLICATION

DIVISION, NCERT

NCERT Campus
Sri Aurobindo Marg
New Delhi 110 016

Phone : 011-26562708

108, 100 Feet Road
Hosdakere Halli Extension
Banashankari III Stage
Bengaluru 560 085

Phone : 080-26725740

Navjivan Trust Building
P.O.Navjivan
Ahmedabad 380 014

Phone : 079-27541446

CWC Campus
Opp. Dhankal Bus Stop
Panihati
Kolkata 700 114

Phone : 033-25530454

CWC Complex
Maligaon
Guwahati 781 021

Phone : 0361-2674869

Publication Team

Head, Publication Division : *M. Siraj Anwar*

Chief Editor : *Shveta Uppal*

Chief Production Officer : *Arun Chitkara*

Chief Business Manager : *Abinash Kullu*

Production Officer : *Abdul Naim*

Cover and Layout

DTP Cell, Publication Division

FOREWORD

The National Curriculum Framework–2005 (NCF–2005) recommends bringing work and education into the domain of the curricular, infusing it in all areas of learning while giving it an identity of its own at relevant stages. It explains that work transforms knowledge into experience and generates important personal and social values such as self-reliance, creativity and cooperation. Through work one learns to find one’s place in the society. It is an educational activity with an inherent potential for inclusion. Therefore, an experience of involvement in productive work in an educational setting will make one appreciate the worth of social life and what is valued and appreciated in society. Work involves interaction with material or other people (mostly both), thus creating a deeper comprehension and increased practical knowledge of natural substances and social relationships.

Through work and education, school knowledge can be easily linked to learners’ life outside the school. This also makes a departure from the legacy of bookish learning and bridges the gap between the school, home, community and the workplace. The NCF–2005 also emphasises on Vocational Education and Training (VET) for all those children who wish to acquire additional skills and/or seek livelihood through vocational education after either discontinuing or completing their school education. VET is expected to provide a ‘preferred and dignified’ choice rather than a terminal or ‘last-resort’ option.

As a follow-up of this, NCERT has attempted to infuse work across the subject areas and also contributed in the development of the National Skill Qualification Framework (NSQF) for the country, which was notified on 27 December 2013. It is a quality assurance framework that organises all qualifications according to levels of knowledge, skills and attitude. These levels, graded from one to ten, are defined in terms of learning outcomes, which the learner must possess regardless of whether they are obtained through formal, non-formal or informal learning. The NSQF sets common principles and guidelines for a nationally recognised qualification system covering Schools, Vocational Education and Training Institutions, Technical Education Institutions, Colleges and Universities.

It is under this backdrop that Pandit Sunderlal Sharma Central Institute of Vocational Education (PSSCIVE), Bhopal, a constituent of NCERT has developed learning outcomes based modular curricula for the vocational subjects from Classes IX to XII. This has been developed

under the Centrally Sponsored Scheme of Vocationalisation of Secondary and Higher Secondary Education of the Ministry of Human Resource Development.

This textbook has been developed as per the learning outcomes based curriculum, keeping in view the National Occupational Standards (NOS) for the job role and to promote experiential learning related to the vocation. This will enable the students to acquire necessary skills, knowledge and attitude.

I acknowledge the contribution of the development team, reviewers and all the institutions and organisations, which have supported in the development of this textbook.

NCERT would welcome suggestions from students, teachers and parents, which would help us to further improve the quality of the material in subsequent editions.

New Delhi
June 2018

HRUSHIKESH SENAPATY
Director

National Council of Educational
Research and Training

ABOUT THE TEXTBOOK

Our country has been witnessing growth in the automotive sector with new developments taking place in all components of automobiles. The automotive manufacturing industry comprises the production of commercial vehicles, passenger cars, three- and two-wheelers, etc. We need trained manpower to carry out the various activities in sales, service and production of automotive products.

Automotive Service Technician Level III is an important job role involving repairing and servicing of automobile vehicle and accessories. An Automotive Service Technician is responsible for installation, minor repair, maintenance and servicing of vehicles. The person should be able to work independently, perform laborious tasks, should be a good listener, good at taking and following instructions, a good team player and result-oriented, with a positive attitude. Automotive Service Technician Level III is a beginner-level course. On completion of this course, a student can take up an intermediate-level course for a job role in the automotive sector, such as Automotive Service Technician Level IV in Class XI and Class XII.

This textbook for the job role of Automotive Service Technician has been developed to impart knowledge skills through hands-on learning experience, which forms a part of the experimental learning. The textbook has been developed with the contribution from the subject experts, vocational teachers and industry experts and academicians for making it a useful and inspiring teaching-learning resource material for the vocational students. Adequate care has been taken to align the contents of the textbook with the National Occupational Standards (NOS) for the job role so that the student acquires the necessary knowledge and skills as per performance criteria mentioned in the respective NOS of the Qualification Pack (QP).

The NOS for the job role of 'Automotive Service Technician' covered through this textbook are as follows:

1. ASC/N 1401: Assist in service, maintenance and repair of the vehicle
2. ASC/N 0001: Plan and organise work to meet expected outcomes
3. ASC/N 0002: Work effectively in a team
4. ASC/N 0003: Maintain a healthy, safe and secure working environment

Unit 1 of the textbook gives the history and evolution of automobiles. Unit 2 focusses on various types of automobiles used in the automobile sector. Unit 3 covers the major systems and components of automobiles. Unit 4 deals with road safety, while Unit 5 deals with automobiles and the environment. Unit 6 gives an introduction to vehicle maintenance and servicing and Unit 7 deals with innovation and development in automobiles.

Some model names of vehicles have been discussed in the textbook with the purpose of creating awareness among the students.

SAURABH PRAKASH
Professor

Department of Engineering and Technology
PSSCIVE, Bhopal

TEXTBOOK DEVELOPMENT TEAM

MEMBERS

A.C. Deb, *Lecturer (Auto)*, Pusa Polytechnic Pusa, New Delhi

A.P. Verma, *Professor (Retd)*, Department of Engineering and Technology, PSSCIVE, Bhopal, M.P.

Deepak Shudhalwar, *Associate Professor*, Department of Engineering and Technology, PSSCIVE, Bhopal, M.P.

Dhrendra Chandra, *General Manager (Retd.)*, UT Roadways, Haldwani, Uttarakhand

Nagendra D. Kore, *Vice Principal and Head*, Automobile Technology Section, P.W. Higher Secondary School, Khorlim, Mapusa, Goa

Sudhir Vishwakatma, *Consultant*, CRISP, Shyamala Hills, Bhopal, M.P.

Sunil K. Chaturvedi, *CEO*, Automotive Skills Development Council, India Habitat Centre, Lodhi Road, New Delhi

Vikas Gautam, *Vocational Trainer*, Sarvodaya Bal Vidyalaya (SBV), Mori Gate, No.1, Delhi

MEMBER-COORDINATOR

Saurabh Prakash, *Professor*, Department of Engineering and Technology, PSSCIVE, Bhopal, M.P.

ACKNOWLEDGEMENTS

The National Council of Educational Research and Training (NCERT) expresses its gratitude to all members of the Project Approval Board (PAB) and officials of the Ministry of Human Resource Development (MHRD), Government of India, for their cooperation in the development of this textbook. The Council also extends gratitude to all the contributors for sharing their expertise and valuable time by positively responding to the request for the development of this textbook. The Council expresses its gratitude towards Rajesh Khambayat, *Joint Director*, PSSCIVE, Bhopal, for providing support and guidance in the development of this textbook. We are thankful to the course coordinator Saurabh Prakash *Professor*, Department of Engineering and Technology, PSSCIVE, NCERT, Bhopal, for his untiring efforts towards solely developing the content for this textbook and also providing photographs used in the textbook. The images used other than these are under Creative Commons License. Kuber Singh Patel, *Junior Project Fellow* and Avinash Singh, *Consultant*, Department of Engineering and Technology, PSSCIVE, Bhopal, are also duly acknowledged for their contribution in the development of this textbook for vocational skills.

The Council is grateful to Saroj Yadav, *Professor and Dean (Academic)*, NCERT, and Ranjana Arora, *Professor and Head*, Department of Curriculum Studies, for evaluating and giving suggestions for the improvement of this book and its finalisation. The Council acknowledges the copy editing and valuable contribution of Madhavi Ratnaparkhi, *Assistant Editor (Contractual)*, Shilpa Mohan, *Assistant Editor (Contractual)* and Garima Syal, *Proofreader (Contractual)* in shaping this book. The efforts of Pawan Kumar Barriar, *DTP Operator*, and Haridarshan Lodhi, *DTP Operator (Contractual)*, Publication Division, Akhilesh Kashiv, *Computer Operator*, Vikas Kumar Koge, *Graphic Artist (Contractual)*, and Pinki Tiwari, *Graphic Designer (Contractual)* and PSSCIVE, NCERT, for flawless layout design are also acknowledged. The Council is also grateful for the support by Automotive Skill Development Council, New Delhi.

CONTENTS

<i>Foreword</i>	<i>iii</i>
<i>About the Textbook</i>	<i>v</i>
Unit 1: History and Evolution of Automobiles	1
Session 1: Invention of Wheel	2
Session 2: Wheel Cart	6
Session 3: Invention of Automobiles	8
Session 4: Invention of Automobiles(Post World War II)	14
Unit 2: Various Types of Automobiles	21
Session 1: Two-wheelers and Three-wheelers	22
Session 2: Passenger Vehicles and Commercial Vehicles	26
Session 3: Agricultural Vehicles	29
Session 4: Construction Equipment Vehicles	31
Session 5: Special Vehicles	35
Unit 3: Major Systems and Components of an Automobile	39
Session 1: Chassis and Auto Body	40
Session 2: Engine and Its Components	44
Session 3: Lubrication System	58
Session 4: Cooling System	60
Session 5: Fuel Supply System	63
Session 6: Transmission System	66
Session 7: Front and Rear Axle	71

Session 8: Steering and Suspension System	74
Session 9: Wheel, Tyre and Brake	81
Session 10: Electrical or Electronic and Air Conditioning Systems	89
Session 11: Active and Passive Safety	94
Unit 4: Road Safety	98
Session 1: Importance of Road Safety	99
Session 2: Safe and Responsible Driving	104
Session 3: Road Signs	109
Session 4: Driving Rules and Registration	130
Session 5: Driving License	138
Unit 5: Automobile and Environment	142
Session 1: Air Pollution	143
Session 2: Auto Emissions and EU/BS Standards	147
Session 3: PUC Certification	152
Unit 6: Introduction to Vehicle Maintenance and Servicing	156
Session 1: Importance of Vehicle Maintenance and Servicing	156
Session 2: Tips to Extend the Life of a Vehicle	162
Session 3: Introduction to Vehicle Service Procedure	165
Unit 7: Innovation and Development in Automobiles	169
Session 1: Innovation and Development	170
<i>Answer Key</i>	179
<i>Glossary</i>	183
<i>List of Credits</i>	186

Unit



History and Evolution of Automobiles

INTRODUCTION

You must have heard the word automobile. The meaning of automobile can be an auto car, motor car or car. It is a wheeled motor vehicle used for transporting goods or passengers, which also carries its own engine or motor. The word automobile comes from the ancient Greek word αὐτός (*autós*, meaning 'self') and the Latin word *mobilis* (movable), therefore automobile means a vehicle that moves itself. The alternative name, 'car' is believed to have originated from the Latin word *carrus* or *carrum* (wheeled vehicle), or the Middle English word *carre* (cart) (from Old North French). These words in turn are said to have originated from the Gaulish word *karros* (a Gallic chariot).

Most definitions of the term specify that automobiles are designed to run primarily on roads, have seating for one or more people, typically have four wheels and are constructed principally for the transport of people and goods.

In this Unit, you will understand the concept of a wheel and the role of a wheel cart. You will also learn the various stages of development over several hundred



17969CH01

years that made possible the invention of an automobile as we know it today.

SESSION 1: INVENTION OF WHEEL

The wheel is considered as one of the most important mechanical inventions of all times. The wheel has been used by man since the beginning of civilisation. Most primitive technologies since the invention of the wheel have been based on its principles.

The invention of the wheel perhaps happened in the late Neolithic age. It is likely that along with other technological advancements, it gave rise to the early Bronze Age.

4500 BC: Invention of the potter's wheel, Chalcolithic (Ubaid period)

4500–3300 BC: Chalcolithic, earliest wheeled vehicles, domestication of the horse

3300–2200 BC: Early Bronze Age

2200–1550 BC: Middle Bronze Age, invention of the spoked wheel and the chariot

Since the Industrial Revolution, the wheel has been a basic element of nearly every machine constructed by mankind. While the exact time and place of the invention of the wheel has been disputed, its beginnings can be seen across ancient civilisations.

History tells us that wheel was most likely invented in Mesopotamia (modern day Iraq) around 3500 BC. This means that the wheel (Fig.1.1) is about 5500 years old!

The first use of the wheel for transportation was in Mesopotamian chariots in 3200 BC. There are many references to wheeled chariots in Indian mythology also, dating to around 3000 BC. It is interesting to note that wheels may have been used in industrial or manufacturing applications before they were used on vehicles. Egyptians started using wheel with spokes, first in chariots around 2000 BC and use of wheels is believed to have started in Europe by 1400 BC.

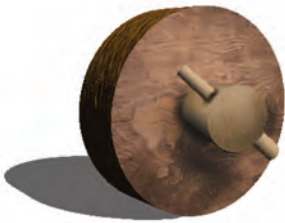
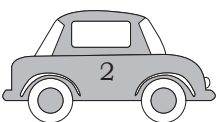

Fig.1.1: Wooden wheel



Wheel and Its Structure

It is hard to imagine any mechanised system that would be possible without a wheel or a idea of a symmetrical component moving in a circular motion about an axis. From tiny watch gears to automobiles, jet engines and computer disk drives, the principle is the same.

Early wheels were simple wooden disks with a hole for the axle. Due to the structure of wood, a horizontal slice of a tree trunk is not suitable, as it does not have the structural strength to support weight without collapsing; rounded pieces of longitudinal boards are required.

The oldest known example of a wooden wheel and its axle was found in 2003 in the Ljubljana Marshes some 20 km south of Ljubljana, the capital of Slovenia. According to the radiocarbon dating, it is between 5100 and 5350 years old. It has a diameter of 72 centimetres (28") and is made of ash wood, whereas its axle is made of oak.

The spoked wheel (Fig. 1.2) was invented much recently, and allowed the construction of lighter and swifter vehicles. Some noteworthy artefacts belonging to the Harappan civilisation of the Indus Valley and North Western India are toy-cart wheels made of clay with spokes painted or in relief, and the symbol of the spoked wheel in the script of the seals.

The earliest known examples of wooden spoked wheels are in the context of the Andronovo culture, dating to circa 2000 BC. Soon after this, horse cultures of the Caucasus region used horse-drawn spoked-wheel war chariots for the greater part of three centuries. They moved deep into the Greek Peninsula where they joined the existing Mediterranean people to give rise, eventually, to classical Greece after the breaking of Minoan dominance and consolidations led by pre-classical Sparta and Athens. Celtic-chariots introduced an iron rim around the wheel in the first millennium BC. The spoked wheel was in continued use without major modification until the 1870s, when wire wheels and pneumatic tires were invented.



Fig.1.2: Wheel with spokes

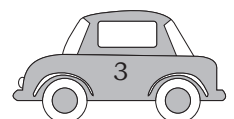



Fig. 1.3: Wheel—a circular component

The invention of the wheel has also been important for application in the water wheel, the cogwheel, the spinning wheel and the astrolabe or torquetum. More modern descendants of the wheel include the propeller, the jet engine, the flywheel (gyroscope) and the turbine. Therefore, we see that a wheel is a circular component (Fig.1.3) that can rotate on its centre. Wheels, in conjunction with axles, allow moving heavy objects with ease. The wheel is the main component of the wheel and axle assembly. Wheel and axle were used in the first carriages. We shall learn about these later.

A wheel greatly reduces friction by facilitating motion by rolling together with the use of axles. In order for wheels to rotate, a push is needed to rotate the wheel about its axis.

The wheel is a device that enables efficient movement of an object across a surface where there is a force pressing the object to the surface. Common examples are a cart pulled by a horse and the rollers on an aircraft flap mechanism.

The low resistance to motion (compared to dragging) is explained as follows.

- The normal force at the sliding interface is the same.
- The sliding distance is reduced for a given distance of travel.
- The coefficient of friction at the interface is usually lower.

The classic spoked wheel with hub and iron rim was in use from about 500 ACE (Iron Age Europe) until the twentieth century AD. We can see the importance of wheel in various places and its role in our day-to-day life. Our national flag also has a circle signifying a wheel with spokes.

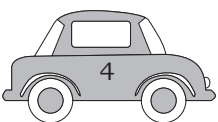

Practical Exercises

NOTES

Activity 1

List the items where wheel is used as a part of machinery.

S.No.	Items	No. of wheels

Activity 2

Identify any two types of wheels and draw their diagrams.

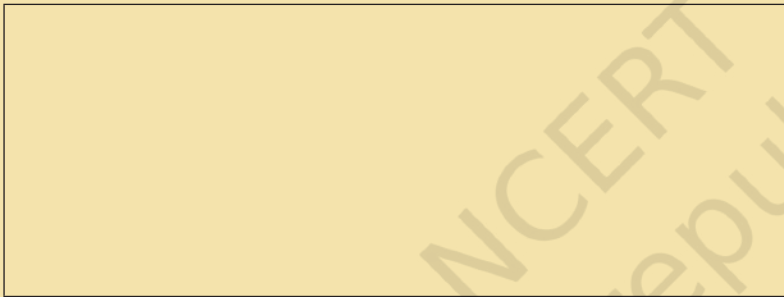

Check Your Progress

A. Fill in the blanks

- _____ is considered as one of the most important mechanical inventions of all times.
- Wheel was invented in _____ in around 3500 BC that is _____ years ago.
- A wheel is a _____ component that can rotate on its centre.
- Wheel is a _____ that enables efficient movement of an _____ across a surface where there is a force pressing it to the surface.
- The coefficient of friction at the interface of wheel is usually _____.

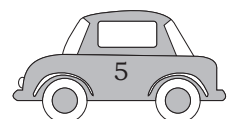

B. Multiple choice questions

1. How many years ago was the wheel invented?
 - (a) 2500 years
 - (b) 3500 years
 - (c) 5000 years
 - (d) 6000 years
2. Spoked wheel is used for which category of vehicle?
 - (a) Light
 - (b) Medium
 - (c) Heavy
 - (d) None of the above
3. Axle of wheel is fitted in the wheel in the _____.
 - (a) top
 - (b) bottom
 - (c) centre
 - (d) side

C. Short answer questions

1. Define a wheel's structure.
2. List the different types of wheel used in transport with examples.

SESSION 2: WHEEL CART

Wheel cart is a vehicle designed for transport, using two wheels. A handcart is pulled or pushed by one or more people. However, history tells us that animals, instead of men, were used for pulling the carts, as they were more powerful. Normally, a cart was pulled by a pair of draught animals. The draught animals used for carts could be horses or ponies, mules, oxen, water buffalo or donkeys, or even smaller animals, such as goats or large dogs.



Fig.1.4: Chariot

Carts have been mentioned in literature as far back as the 2nd millennium BC. The Indian epic Mahabharata, which depicts Lord Krishna as the *saarathi* (the charioteer of the *rath*) and the chariot (Fig.1.4) carrying *Pandava* prince Arjuna in the battlefield of Kurukshetra, are some of the examples. In the Mahabharata war, all the leaders used a *rath* for fighting in the war.

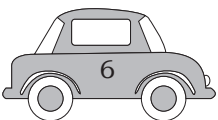

Types of Cart

Carts have been in continuous use since the invention of the wheel in 3500 BC. Carts may be named after the animal that pulls them, such as horse-cart or ox-cart. In present times, horse-carts are used in competitions. A dog-cart, however, is usually a cart designed to carry hunting dogs. It is an open cart with two cross-seats back to back; the dogs can be penned between the rear-facing seat and the back end.



Fig. 1.5: Bullock-cart

A bullock-cart or ox-cart (Fig.1.5) is a two-wheeled vehicle pulled by oxen (draught cattle). It is a means of transportation used since ancient times in many parts of the world. They are used even today in places where modern vehicles are too expensive or the infrastructure does not favour them.

Carts are used especially for carrying goods. Bullock-cart is pulled by one or two bullocks. The cart is attached to a bullock team by a special chain attached to yokes, but a rope may also be used for one or two animals. The driver and any other passenger can sit on the front of the cart, while the load is placed at the back.

Horse Power

How many men would be needed to equal the power of a horse?

After conducting some experiments, it was found that, on an average 10–12 men were needed to equal the power of one horse. This is the reason why mankind thought of using horses for pulling carts. This led to the development of a horse carriage.

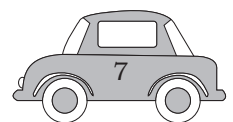

Practical Exercises

Activity 1

List the different types of cart you have seen in your locality.

S.No.	Types of carts	No. of wheels
1		
2		
3		
4		
5		

Check Your Progress

A. Fill in the blanks

1. Carts are driven by_____.
2. In Mahabharata, the chariot was pulled by_____.
3. A bullock-cart or ox-cart is a _____ pulled by oxen(draught animal).
4. An average _____ men are needed to equal the power of one horse.

B. Short answer questions

1. How does a wheel cart help the farmer?
2. Why were wheel carts used during Mahabharata?
3. List the different types of carts.
4. Define horsepower.

SESSION 3: INVENTION OF AUTOMOBILES

Till now, we have learnt how the wheel was used in carts and about horse carriages for transportation of goods and people. Engineers kept improving the horse carriage design bit by bit. At the same time, people were working on a system that could be self-propelled,

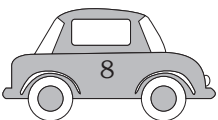

meaning that the system could be run without any man or animal force required for moving it.

In the year 1672, the very first such model (Fig.1.6) was developed in the form of a toy. This was actually a steam engine, in which the power of steam was used to provide momentum to the toy.

Further improvements continued in various parts of the world. Then in the year 1806, the first car (Fig.1.7) powered by an internal combustion engine appeared. The fuel used for running this was 'fuel gas' instead of 'steam'. The process of using fuel gas is different from that of steam. Steam engine requires 'external combustion', whereas fuel gas uses the principle of 'internal combustion'. We shall study this in detail later.

Meanwhile, engineers continued to improve designs till the year 1885 when the first modern gasoline-or petrol-fueled engine was developed in Europe. It is important to note that inventions in science and technology cannot often be used immediately by general public. One reason is that the cost of developing new technology is very high. Also, the first models usually do not have any comfort features. However, when more people raise demand for the new models, the cost starts to come down. More features can also be added for making it attractive to general consumers.

Karl Benz, a German engineer designed and patented the first practical model (Fig.1.8) in 1885. This model used internal combustion engine and was called Motorwagen. Although several other German engineers (including Gottlieb Daimler, Wilhelm Maybach and



Fig. 1.6: Cugnot Steam trolley



Fig. 1.7: First practical car model



Fig. 1.8: Photograph of the original Benz Patent—Motorwagen, first built in 1885

Siegfried Marcus) were working on the problem at about the same time, Karl Benz generally is acknowledged as the inventor of the modern automobile.

Karl Benz built an automobile powered by his own four-stroke cycle gasoline engine in Mannheim, Germany in 1885 and was granted a patent in January of the following year, under the auspices of his major company, Benz & Cie., which was founded in 1883. It was an integral design, without the adaptation of other existing components and included several new technological elements to create a new concept. Benz began to sell his production vehicles in 1888.



Fig. 1.9: Bertha Benz

In 1879, Benz was granted a patent for his first engine, designed in 1878. Many of his other inventions made the use of the internal combustion engine feasible for powering a vehicle. His first motor wagon was built in 1885, and he was awarded the patent for this invention, based on his application on 29 January 1886. Benz began promotion of the vehicle on 3 July 1886, and about 25 Benz vehicles were sold between 1888 and 1893, when his first four-wheeler was introduced along with a model intended for affordability. They were also powered with four-stroke engines of his own design. Emile Roger of France, already producing Benz engines under licence, also added the Benz automobile to his line of products. Since France was more open to the early automobiles, therefore, in the initial period more automobiles were built and sold in France through Roger, than Benz sold in Germany.

In August 1888, Bertha Benz, (Fig. 1.9) wife of Karl Benz, undertook the first roadtrip by car, to prove the road-worthiness of her husband's invention (Fig. 1.9). During the last years of the nineteenth century, Benz was the largest automobile company in the world with 572 units produced in 1899.

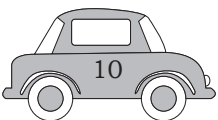

Towards the end of nineteenth century, many automobile companies came up in Europe and America. They started producing different models. But these automobiles were expensive and only a few rich people could afford them like kings, queens and *raj*as in India.

An average person could not afford to own a car. Many attempts were made in Europe and America for reducing the costs. The large-scale, production-line manufacturing of affordable automobiles was started by Ransom Olds at his Oldsmobile factory in 1902, based on the assembly line techniques pioneered by Marc Isambard Brunel at the Portsmouth Block Mills, England in 1802. The assembly line style of mass production and interchangeable parts had been pioneered in the U.S. by Thomas Blanchard in 1821, at the Springfield Armory in Springfield, Massachusetts. This concept was greatly expanded by Henry Ford, beginning in 1914. With the introduction of this new manufacturing process, Ford Motor company launched the first large-scale production of their Model T. (Fig. 1.10). In 1914, an assembly line worker could buy a Model T with four months' pay.



Fig. 1.10: Car Ford Model T

In Europe the same happened. Morris set up its production line at Cowley in 1924 and soon outsold Ford, while beginning in 1923 to follow Ford's practice of vertical integration. Morris bought Hotchkiss (engines), Wrigley (gearboxes), and Osberton (radiators). In 1925, Morris had 41 per cent of the total British car production. Most British small-car assemblers, from Abbey to Xtra, had failed. Citroën, a French automobile manufacturer, started building motor cars in 1919 and employing mass production techniques, within a year, was manufacturing 100 cars a year. Renault's 10CV and Peugeot's 5CV, produced 550,000 cars in 1925, and Mors, Hurtu and others could not compete. Germany's first mass-manufactured car,



Fig. 1.11: 1926 Austin 7 Box

the Opel 4PS Laubfrosch (Tree Frog), came off the line at Russelsheim in 1924, soon making Opel the top car builder in Germany, with 37.5 per cent of the market.



Fig. 1.12: Mark V Tank

In 1926, Austin 7 Box was an economy car produced by Austin company (see Fig. 1.11).

Between the World Wars I and II, a lot of attention of the automobile industry went towards development of defence vehicles. As a result, several new vehicles like battletanks and jeeps were developed. The tank (Fig. 1.12) became very popular in the war field. It is a very versatile vehicle which can run in any road conditions, i.e., in cross-country terrain, hills, deserts, trenches, etc.



Fig. 1.13: Jeweled one-millionth VW Beetle

However, during this period, there were some very interesting designs in the passenger segment also. Volkswagen in Germany developed a car in 1930s, which looked like a crawling creature and was therefore called 'Beetle' (Fig. 1.13). This model had the engine at the back and the front bonnet was used as the luggage compartment. The car was very convenient to drive and looked stylish. It became popular in Europe.



Fig. 1.14: Volkswagen type 1s model car

By 2002, over 21 million Volkswagen Type 1s (Fig. 1.14) had been produced, but by 2003, the annual production had dropped to 30,000 from a peak of 1.3 million in 1971. Volkswagen announced the end of production in June 2003. However, the opinion in the U.S. was not very good, perhaps because of the characteristic differences between the American and European

car markets. Henry Ford II, the grandson of Henry Ford, once described the car as 'a little box'.

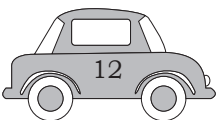

Practical Exercises

Activity 1

Make a list of the automobile vehicles developed in the past.

S.No.	Type of vehicle	Model

Check Your Progress

A. Fill in the blanks

1. In the year _____ the very first model of a self-propelled system was developed in the form of a toy.
2. In year 1806, the first cars powered by _____ appeared.
3. _____, a German engineer, designed and patented the first practical model of an engine in 1885.
4. Volkswagen developed a car in the 1930s which looked like a crawling creature and was therefore called _____.

B. Multiple choice questions

1. In which year was the first vehicle invented?
(a) 1885 (b) 1650
(c) 1806 (d) None of the above
2. Who was the inventor of the first patented car?
(a) Karl Benz (b) Ratan Tata
(c) Mohandas Singh (d) None of the above
3. Which of these is Germany's first mass-manufactured car?
(a) Opel 4PS *Laubfrosch* (b) Volkswagen
(c) Ambassador (d) None of the above

C. Assignment

1. Make a list of the important manufacturers of cars in India.

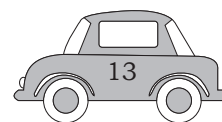

SESSION 4: INVENTION OF AUTOMOBILES (POST WORLD WAR II)

Till now we have studied about the developments in the automotive sector before World War II.

Post World War II, the automotive industry showed rapid modernisation in the 1950s and 1960s. Many new car models were introduced like Edsel, Chevrolet, etc.

In the U.S., road network was built after the World War II. This road network was quite modern with long highways stretching across the length and breadth of the country. It is noteworthy that U.S. has a large landmass and vast geography, which allows open and wide roads to be built. On these roads models like the Beetle do appear very tiny!

The Big Three of the car industry, namely General Motors, Ford and Chrysler set about to design big fast-moving cars for the American roads. Edsel, Buick, Pontiac Firebird, Chevrolet Impala, etc., were some of the big cars that came on American highways in the 1950s and 1960s. It may also be noted that these models used large amounts of petrol or gasoline as it is called in the U.S. But, petrol consumption was not a grave concern in those days. So, each car maker competed with the others in making bigger and better designs with more luxuries added for comfort. All this made owning and maintaining a car quite costly. However, more and more Americans bought these models. One very popular model from Ford was named 'Mustang'.

However, things changed after 1973. This was the year of the first 'Oil Crisis'. Petrol started becoming costlier as all the Arab nations got together in an alliance. Now, suddenly even Americans started looking for more economical designs.

Meanwhile, quietly but with determination, Japan was developing cars for marketing worldwide, mainly in the U.S. Actually, after the devastation of their country during World War II, several Japanese companies came into existence like Toyota, Mazda, Mitsubishi, Suzuki, etc. Some of these like Mazda, were using American technology. But these companies were also developing their own research capabilities. As a result, when the

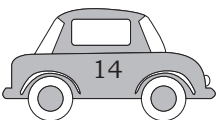

1973 oil crisis occurred, these companies were very well positioned to roll out smaller, compact, economical models in the U.S.

Since then, companies like Toyota, Honda have been steadily increasing their market presence worldwide. There are some technical and design aspects that differentiate modern cars from antiques. The modern era has been one of increasing standardisation, platform sharing and computer-aided design.

- (i) Toyota Corolla (1966–present)—a simple small Japanese saloon/sedan that has come to be the best-selling car of all time.
- (ii) Range Rover (1970–present)—the first take on the combination of luxury and four-wheeled drive utility, the original ‘SUV’. Such was the popularity of the original Range Rover Classic that a new model was not brought out until 1994.
- (iii) Mercedes-Benz S-Class (1973–present)—features like electronic anti-lock braking system, supplemental restraint airbags, seat belt pretensioners and electronic traction control systems made their debut in the S-Class. These features later became standard throughout the car industry.
- (iv) BMW 3 Series (1975–present)—the 3 Series has been on the Car and Driver magazine’s annual Ten Best list 17 times, making it the longest running entry in the list.
- (v) Honda Accord (1977–present)—this Japanese sedan became the most popular car in the U.S. in the 1990s, pushing the Ford Taurus aside, and setting the stage for today’s upscale Asian sedans.
- (vi) Dodge Aries and Plymouth Reliant (1981–89)—the ‘K-cars’ that saved Chrysler as a major manufacturer. These models were some of the first successful American front-wheel drive, fuel-efficient compact cars.
- (vii) Chrysler minivans (1983–present)—the two-box minivan design nearly pushed the station wagon out of the market, and presaged today’s crossover SUVs.

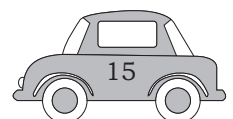

NOTES

- (viii) Renault Espace (1984–present)—first mass one-volume car of non-commercial MPV class.
- (ix) Ford Taurus (1986–present)—this mid-sized front-wheel drive sedan with modern computer-assisted design dominated the American market in the late 1980s, and created a design revolution in North America.
- (x) Pontiac Trans Sport (1989–99)—it was one of the first one-box cars.
- (xi) Toyota Prius (1997–present)—launched in the Japanese market, it reached a worldwide cumulative sales of 2 million units in September 2010, becoming the most iconic hybrid electric vehicle in the world.
- (xii) Ford Focus (1998–present)—one of the most popular hatchbacks across the globe, which is also one of Ford’s best-selling world cars.
- (xiii) Tata Nano (2008–present)—it is an inexpensive (₹1,00,000), rear-engine, four-passenger city car built by an Indian company, Tata Motors, and is aimed primarily at the Indian domestic market.
- (xiv) Nissan Leaf and Chevrolet Volt (2010–present)—all these electric cars were launched in the American and Japanese markets in December 2010, thereby becoming the first mass production vehicles of their kind.

Indian Automobile Scenario

The automotive industry in India started with the import of cars for royal families, which perhaps started in 1920s.

For many years, India did not have any manufacturing capability of its own. Hindustan Motors is one of the initial car manufacturers in India, founded in 1942 by B.M. Birla. It was a leader in car sales until the 1980s, when the industry was opened up from protection. Hindustan Motors was the producer of the Ambassador car (Fig. 1.15), widely used as a taxicab and as a government limousine. This car was based on the Morris Oxford, a British car that dates back to 1954. The production of Ambassador stopped in 2014.

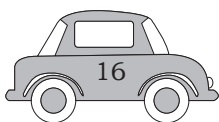

Another Indian company, Premier Automobiles was founded in 1944. The company first launched production of vehicles under licence from Dodge and Plymouth. In 1951, they began producing versions of Fiat 500 for the Indian market. This was followed by Fiat 1100 in 1954. In 1973, Premier renamed the Fiat 1100 as the 'Premier Padmini' (Fig. 1.16). Ambassador and Fiat/Padmini were the two dominant models of cars on the Indian roads till 1983.

In 1983, the Government of India started Maruti Udyog in collaboration with Suzuki of Japan. Maruti's first model called Maruti 800 (Fig. 1.17) became a huge success. Within 5–6 years the company reached an annual production of nearly 1,00,000 cars. They launched various models like 800, Gypsy, Omni van, Esteem, Zen, Baleno, etc.

By the end of 1990s, several other global multinational car makers also started manufacturing their models in India. Among them were General Motors, Ford, Hyundai, etc. In just a few years the Indian market for cars became a hotspot of global automotive activity.

As we see, the Indian auto industry started with the import of cars in the 1920s, followed by manufacturing in 1940s. With continued progress many Indian companies like Maruti, Tata, Mahindra have become big global names. They are not merely manufacturing European/American or Japanese designs, but are doing so with their own research and development capabilities. As a result of this, Nano model was developed by Tata Motors, which is the cheapest car in the world with all convenient and quality features. India also exports nearly 12 per cent of manufactured cars to Europe, U.S. and elsewhere in the world.



Fig. 1.15: Ambassador car



Fig. 1.16: Premium Padmini car



Fig. 1.17: Maruti 800 car

The automotive industry in India is one of the largest in the world and one of the fastest growing globally.

According to the Society of Indian Automobile Manufacturers, annual vehicle sales were projected to increase to 5 million by 2015 and more than 9 million by 2020. By 2050, the country is expected to top the world in car volumes with approximately 611 million vehicles on the nation's roads.

The majority of India's car manufacturing industry (Fig. 1.18) is based around three clusters in the south, west and north. The southern cluster near Chennai is the biggest with 40 per cent of the revenue share. The western hub near Pune is 33 per cent of the market. The northern cluster is primarily Haryana with 32 per cent. Chennai is also referred to as the 'Detroit of India' with the Indian operations of Ford, Hyundai, Renault and



Fig. 1.18: India's Car Manufacturing Industry

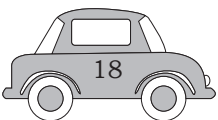

Nissan headquartered in the city and BMW having an assembly plant on the outskirts. Chennai accounts for 60 per cent of the country's automotive exports. Gurugram and Manesar in Haryana form the northern cluster where the country's largest car manufacturer Maruti Suzuki is based. The *Chakan* corridor near Pune, Maharashtra is the western cluster with companies like General Motors, Volkswagen, ŠKODA, Mahindra and Mahindra, Tata Motors, Mercedes Benz, Land Rover, Fiat and Force Motors having assembly plants in the area. Aurangabad with Audi, ŠKODA and Volkswagen also forms part of the western cluster. Another emerging cluster is in the state of Gujarat with manufacturing facility of General Motors in Halol and further planned for Tata Nano at Sanand. Ford, Maruti Suzuki and Peugeot-Citroen plants are also set to come up in Gujarat. Kolkata with Hindustan Motors, Noida with Honda and Bengaluru with Toyota are some of the other automotive manufacturing regions around the country.

Practical Exercises

Activity 1

List five models of cars of different companies.

S.No.	Name of model
1.	
2.	
3.	
4.	
5.	

Check Your Progress

A. Fill in the blanks

1. A very popular model from Ford was named _____.
2. The Big Three of the car industry, namely General Motors, Ford and Chrysler set out to design big fast, moving cars for the _____ roads.

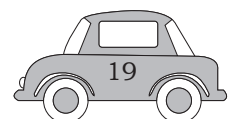

3. The first cars imported in India were in _____.
4. _____ and _____ were the two dominant models of cars on the Indian roads till 1983.
5. In 1983, the Government of India started Maruti Udyog in collaboration with _____ of Japan.
6. The first Indian car which is cheapest in the world is _____.

B. Multiple choice questions

1. In which year was the first car imported in India?
 - (a) 1920
 - (b) 1942
 - (c) 1970
 - (d) None of the above
2. Which of these is the first car manufactured in India?
 - (a) Ambassador
 - (b) Fiat
 - (c) Nano
 - (d) Padmini
3. Which city is referred to as the “*Detroit of India*”?
 - (a) Pune
 - (b) Gurugram
 - (c) Chennai
 - (d) Delhi
4. In which year was the India company Premier Automobiles founded?
 - (a) 1940
 - (b) 1944
 - (c) 1960
 - (d) 1970

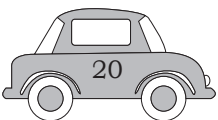

AUTOMOTIVE SERVICE TECHNICIAN - CLASS 9

UNIT 1 : HISTORY AND EVOLUTION OF AUTOMOBILES

SESSION 1: INVENTION OF WHEEL

Check Your Progress

A. Fill in the blanks

1. _____ is considered as one of the most important mechanical inventions of all times.
2. Wheel was invented in _____ in around 3500 BC that is _____ years ago.
3. A wheel is a _____ component that can rotate on its centre.
4. Wheel is a _____ that enables efficient movement of an _____ across a surface where there is a force pressing it to the surface.
5. The coefficient of friction at the interface of wheel is usually _____.

B. Multiple choice questions

1. How many years ago was the wheel invented?
(a) 2500 years
(b) 3500 years
(c) 5000 years
(d) 6000 years
2. Spoked wheel is used for which category of vehicle?
(a) Light
(b) Medium
(c) Heavy
(d) None of the above
3. Axle of wheel is fitted in the wheel in the _____.
(a) top
(b) bottom
(c) centre
(d) side

C. Short answer questions

1. Define a wheel's structure.
2. List the different types of wheel used in transport with examples.

SESSION 2: WHEEL CART

Check Your Progress

A. Fill in the blanks

1. Carts are driven by_____.
2. In Mahabharata, the chariot was pulled by_____.
3. A bullock-cart or ox-cart is a _____ pulled by oxen(draught animal).
4. An average _____ men are needed to equal the power of one horse.

B. Short answer questions

1. How does a wheel cart help the farmer?
2. Why were wheel carts used during Mahabharata?
3. List the different types of carts.
4. Define horsepower.

SESSION 3: INVENTION OF AUTOMOBILES

Check Your Progress

A. Fill in the blanks

1. In the year _____ the very first model of a self-propelled system was developed in the form of a toy.
2. In year 1806, the first cars powered by _____ appeared.
3. _____, a German engineer, designed and patented the first practical model of an engine in 1885.
4. Volkswagen developed a car in the 1930s which looked like a crawling creature and was therefore called _____.

B. Multiple choice questions

1. In which year was the first vehicle invented?
(a) 1885 (b) 1650
(c) 1806 (d) None of the above
2. Who was the inventor of the first patented car?
(a) Karl Benz (b) Ratan Tata
(c) Mohandas Singh (d) None of the above
3. Which of these is Germany's first mass-manufactured car?
(a) Opel 4PS *Laubfrosch* (b) Volkswagen
(c) Ambassador (d) None of the above

C. Assignment

1. Make a list of the important manufacturers of cars in India.

SESSION 4: INVENTION OF AUTOMOBILES (POST WORLD WAR II)

Check Your Progress

A. Fill in the blanks

1. A very popular model from Ford was named _____.
2. The Big Three of the car industry, namely General Motors, Ford and Chrysler set out to design big fast, moving cars for the _____ roads.
3. The first cars imported in India were in _____.
4. _____ and _____ were the two dominant models of cars on the Indian roads till 1983.
5. In 1983, the Government of India started Maruti Udyog in collaboration with _____ of Japan.
6. The first Indian car which is cheapest in the world is _____.

B. Multiple choice questions

1. In which year was the first car imported in India?
 - (a) 1920
 - (b) 1942
 - (c) 1970
 - (d) None of the above
2. Which of these is the first car manufactured in India?
 - (a) Ambassador
 - (b) Fiat
 - (c) Nano
 - (d) Padmini
3. Which city is referred to as the "Detroit of India"?
 - (a) Pune
 - (b) Gurugram
 - (c) Chennai
 - (d) Delhi
4. In which year was the India company Premier Automobiles founded?
 - (a) 1940
 - (b) 1944
 - (c) 1960
 - (d) 1970

Unit



Various Types of Automobiles

INTRODUCTION

The Indian automotive industry is one of the biggest in the world and growing rapidly globally. The Indian automobile industry produced 2,90,75,605 vehicles including passenger vehicles, commercial vehicles, three-wheelers, two-wheelers and quadricycle in April-March 2018 as against 2,53,30,967 in April-March 2017, registering a growth of 14.78 per cent over the same period last year. In terms of the global ranking in manufacturing output, India is the second largest in two-wheelers, eighth largest in commercial vehicle, sixth largest in passenger cars and the largest in tractors.

The automobile segment comprises the following four broad categories of vehicles.

- Two-wheelers and three-wheelers
- Passenger vehicles
- Commercial vehicles
- Special application vehicles

Two-wheelers, being the most popular means of personal transport, account for about 80 per cent



17969CH02

(as per 2015-16 data) of the total automobile production in India, while passenger vehicles account for nearly 16 per cent of the production. However, owing to their lower price, two-wheelers account for only around 32 per cent of the sales in terms of value, while passenger vehicles account for around 62 per cent of sales.

In this Unit, we will study the different types of vehicles used in our country *viz.*, two-wheeler, three-wheeler, passenger vehicles, commercial vehicles, agricultural vehicles, construction equipment vehicles and special application vehicles.

SESSION 1: TWO-WHEELERS AND THREE-WHEELERS

Two-wheelers

As the name suggests, two-wheeler refers to vehicles that run on two wheels (see Fig. 2.1). Two-wheelers are used all over the world. In developed, rich countries, two-wheelers are used more for recreational purpose, whereas in our country it is an important means of transportation of passengers, both in urban as well as rural areas. India has the largest population of two-wheelers. More than 5.4 million two-wheelers are produced in our country every year. Motorcycles, scooters and mopeds are the categories of two-wheelers used in our country. Motorcycles account for about 78 per cent in the two-wheeler segment. Remaining 22 per cent comprise scooters and mopeds.

India is the second largest manufacturer of two-wheelers in the world. In the last few years, the Indian two-wheeler industry has seen massive growth. The country stands next to China and Japan in terms of production and sales, respectively.

Majority of Indians, especially the youngsters, prefer motorcycles over cars. Holding a large share in the two-wheeler industry, motorcycles and scooters cover major areas, in terms of usage. Large varieties of two-wheelers are available in the market that adopt latest technology and provide enhanced mileage.

Benefits of Two-wheelers

A motorcycle is a motor-powered two-wheeler, similar in construction to bicycles.

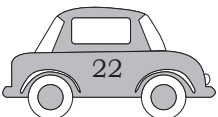

Two-wheelers are the most popular and highly sought after medium of transport in India, as they offer many benefits, like—

- (i) Economical price
- (ii) Safety
- (iii) Fuel-efficiency

There is an increasing trend of owning high-performance imported motorcycles like Suzuki Hayabusa, Kawasaki Ninja, Suzuki Zeus and Honda Unicorn.

Identification of Two-wheelers

You must have seen various types of two-wheelers in your locality or on the roads. Every two-wheeler has a sticker of its model type and name of the manufacturer. You can identify the make of the two-wheeler by the sticker or logo fixed on its body. Two-wheeler manufacturers produce different models each with different specifications. Popular brands of two-wheeler manufacturers are Hero, Honda, Bajaj, TVS and Suzuki. Some of their popular models include

- Hero — Impulse, Splendor, CDdawn, Pleasure, Passion Plus
- Bajaj — Pulsar, Discover, Platina
- TVS — Apache, Star, Scooty Streak, Scooty Pep, Star City
- Honda — Activa, Dio, Aviator
- Suzuki — Access, Intruder M800, Zeus

These models vary in size, weight, dimension type and engine capacity.



Fig. 2.1: Different types of two-wheelers

Three-wheelers

A three-wheeler is a vehicle (Figs 2.2 and 2.3) with three wheels, either 'human-or people-powered vehicles' (HPV or PPV) or motored vehicles in the form of a tri-motorcycle, all-terrain vehicle (ATV) or automobile.



Fig. 2.2: Autorickshaw

Autorickshaws (often called auto) are common all over India, and provide cheap and efficient transportation. Autorickshaws are found in villages, cities and in the countryside. The new autorickshaws operate on CNG (Compressed Natural Gas) and are environment-friendly. The average mileage of an Indian-made autorickshaw is around 35 kilometres per litre of petrol. Many major nationalised banks in India offer loans to self-employed individuals seeking to buy autorickshaws. Important autorickshaw manufacturers in India are Mahindra & Mahindra, Piaggio Ape, TVS Motors, Bajaj Auto, Kerala Auto Limited and Force Motors (previously *Bajaj Tempo*).

Mostly, two types of autorickshaws are used in India—the older versions in which the engine is fitted below the driver's seat, and the newer versions in which the engine is fitted in the rear portion. These autorickshaws run well on petrol, CNG and diesel. A three-wheeler autorickshaw can accommodate four persons including the driver. Some parts of Maharashtra have six-seater rickshaws. In cities and towns across India, autorickshaw is the backbone of city transport. Fare rates of these autorickshaws are controlled by government agencies.



Fig. 2.3: Battery-powered Three-wheeler

Several types of three-wheelers run with the support of motorcycle-based fitted machines, which are called trikes. These trikes have a front single wheel, the mechanics are quite similar to that of a motorcycle and the rear axle is similar to that of a car. Many times, these vehicles are constructed by local mechanics using a portion of the rear engine.

Similarly, many trikes including All Terrain Vehicles (ATVs) are specially constructed for off-road use. Mostly three-wheeled vehicles have either one wheel at the back and two at the front, or one wheel at the front and two at the back.

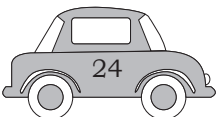

Practical Exercises

Activity 1

List the types of two-wheelers and three-wheelers used in your locality.

S.No.	Name of model

Check Your Progress

A. Fill in the blanks

1. A two-wheeler refers to _____ that run on two wheels.
2. A motorcycle is a motor-powered _____, similar in construction to a bicycle.
3. A three-wheeler is a vehicle with _____ either 'human or people-powered vehicles' (HPV or PPV) or motored vehicles in the form of a _____ or automobile.
4. Autorickshaws are _____ all over India, and provide cheap and efficient _____.
5. New autorickshaws run on _____ and are environment-friendly.

B. Multiple choice questions

1. What is the typical mileage of an Indian-made autorickshaw per liter of petrol?
(a) 25 km (b) 30 km
(c) 35 km (d) 40km
2. Trikes-based machines are fitted in _____.
(a) 2-wheelers (b) 3-wheelers
(c) 4-wheelers (d) None of these
3. Two-and three-wheelers are run by a common fuel known as _____.
(a) Petrol (b) Diesel
(c) CNG (d) All of these

C. Short answer questions

1. Differentiate between two-wheelers and three-wheelers.
2. List the uses of three-wheelers.

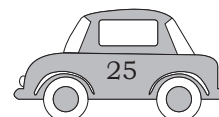

SESSION 2: PASSENGER VEHICLES AND COMMERCIAL VEHICLES

Passenger Vehicles

A passenger vehicle refers to a machine that can carry a person or a group of persons. There are different types of passenger vehicles like cars, jeeps, tempos, etc. You must have seen various models of passenger vehicles in your village, town or city. You must have also travelled in these passenger vehicles.

The details of some of the popular models of cars, buses, jeep and tempos have been illustrated below.

Car

A motor car or car is a vehicle used for transporting passengers, which also carries its own engine or motor. Various popular cars in India are by Maruti Suzuki, Tata Motors, Hyundai, Honda, Mahindra, Datsun, Volkswagen, Suzuki, etc. Nowadays, various car manufacturers of international level have established in our country and have started production of cars here.

Jeep

Jeep is the oldest vehicle used as an off-road vehicle. Willys Overland produced the first Jeep. It is the marque of the brand Chrysler. It has excellent off-road capabilities, and although it was designed primarily to aid military requirements, the company started producing civilian models too by changing the design. Various changes under different leaderships were also made. Jeep is now part of the Chrysler Group LLC which is under

Fiat Italy. The company celebrated its 70th anniversary in 2011. Jeep is found in many countries around the world, and the popular models are Jeep Grand Cherokee, Jeep Patriot, Jeep Compass, Jeep Liberty, Jeep Commander and Jeep Wrangler (Fig. 2.4).



Fig.2.4: Jeep

Commercial Vehicles

A commercial vehicle is a type of motor vehicle that is generally used for transporting

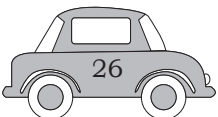

goods as well as passengers. Commercial vehicles support the trade, commerce and industry of a country in a major way. Vehicles falling under this category are mainly buses and trucks (Fig. 2.5). They help in transportation of goods, shipping and handling of various commodities and so on. The future of companies manufacturing these vehicles is quite bright in view of India's growing commercial sector.

Trucks

Trucks (Fig.2.6) are used for carrying goods and material in bulk. As per size and functional use, trucks are classified into sub-categories—rigid trucks, tippers, haulage, cabs, delivery vans and trailers. The fuel efficiency of these vehicles have improved in the past few years. The major truck manufacturers in India are Ashok Leyland, Tata Motors, Eicher, and Swaraj Mazda.

Bus

A bus is a huge commercial vehicle, said to have originated in France in the year 1826 designed by Stanislas Baudry under the name of 'Omnibus'. The main purpose of this vehicle is to carry the passengers as it is a cost-effective medium of transportation.

The major producers of buses in India are Ashok Leyland and Tata Motors, Swaraj Mazda,



Fig.2.5: Commercial vehicle (Bus)



Fig.2.6: Truck



Fig. 2.7: CNG Bus

Volvo and Hindustan Motors. These companies have made a big name in manufacturing mini bus too. The various sub-categories of buses like commuter buses, school buses and electric buses are also available. In India, CNG buses are more popular due to fuel efficiency and being environment-friendly vehicles (see Fig.2.7).

Practical Exercises

Activity 1

List the models of passenger vehicle and commercial vehicle used in your area.

S.No.	Name of model

Activity 2

Identify two types of passenger and commercial vehicles in your area and draw their diagrams in your notebook.

Check Your Progress

A. Fill in the blanks

1. A passenger vehicle refers to a machine that runs on _____ wheels.
2. Trucks are used for carrying _____ in bulk.
3. _____ produced the first jeep.
4. A commercial vehicle is used for _____.

C. Short answer questions

1. Who invented the jeep?
2. Differentiate between passenger and commercial vehicles.
3. Discuss the importance of transport vehicle in India.

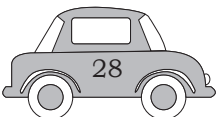

SESSION 3: AGRICULTURAL VEHICLES

Tractor

Agricultural vehicles are used for farming. They include tractors, harvesters, etc. A tractor (Fig. 2.8) is a motor vehicle with large back wheels and thick tyres and is used in farms for pulling machinery at a slow speed. Tractors are mostly used for carrying the trailer or machinery used in agriculture or construction. It can be said that a tractor is a farm vehicle that provides the power and traction to mechanise agricultural tasks, especially (and originally) tillage. Agricultural implements are pulled behind or mounted on the tractor. The tractor also provides power to stationary equipment like thresher, blower, etc. Tractors are heavy vehicles used for pulling or pushing agricultural machinery or trailers at an extremely low speed. India is majorly an agricultural country and tractors are used on a large scale. Tractors are heavy vehicles and are used for carrying out agricultural operations in a systematic way to get more output.

Modern tractors usually employ large diesel engines which range in power output from 18 to 575 horsepower. The major producers of tractors in India are TAFE, Eicher, Mahindra, Ashok Leyland, Escorts, John Deere, Force Motors and Swaraj Enterprise. 'Tractor' is the most commonly used term for the vehicle used on farms. The farm tractor is used for plowing, tilling, disking, harrowing, planting and similar tasks. A variety of specialty farm tractors have been developed for different purposes. These include row crop tractors with adjustable tread width to allow the tractor to pass down rows of corn, tomatoes or other crops. Many utility tractors are used for non-farm grading, landscape maintenance and excavation purposes, particularly with loaders, backhoes, pallet forks and similar devices. Small garden or lawn tractors designed for sub-urban and semi-rural gardening and landscape maintenance also exist in a variety of configurations. Tractors with small horsepower are known as power tillers. The durability



Fig. 2.8: Tractor



Fig.2.9: Harvester



Fig.2.10: Combine harvester loading the grain in a trolley

and engine power of tractors make them very suitable for engineering tasks.

Combine Harvester

The combine harvester (Figs 2.9 and 2.10) is a machine that harvests grain crops. This machine combines three separate operations — reaping, threshing and winnowing — into a single process. Among the crops harvested with a combine are wheat, oats, rye, barley, corn (maize), soybeans and flax (linseed). The waste straw left behind on the field are dried stems and leaves of the crop with low nutrients. This leftover straw is either chopped and spread on the field or baled for feed and bedding for livestock. Combine harvesters are one of the most economically important labour-saving inventions, enabling a small fraction of the population to engage in agriculture.

Practical Exercises

Activity 1

List the models of agricultural vehicles used in your area.

S. No.	Name of model

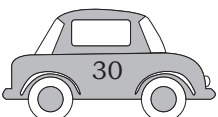

Check Your Progress

A. Fill in the blanks

1. Agricultural _____ may be towed behind or mounted on the tractor.
2. An agricultural vehicle is a farm vehicle that provides _____ and traction to _____ agricultural tasks.
3. Combines are used for _____ and _____.
4. Combines are one of the most economically important _____ inventions.

B. Short answer questions

1. What are the uses of a tractor?
2. How have agricultural vehicles helped the farmers in India?

SESSION 4: CONSTRUCTION EQUIPMENT VEHICLES

Lot of new roads, houses and industrial plants are being built these days. You must have seen big machines being used at the construction sites to dig earth. These are Special Purpose Automobiles and are sometimes called Earth Moving Equipment.

There are several types of Earth Moving or Construction Equipment, such as

- (i) Bulldozers
- (ii) Road rollers
- (iii) Dumpers
- (iv) Excavators

As their names suggest, they are used for various types of work like digging or excavating earth and dumping it at a designated place. Road rollers are used for levelling roads.

Bulldozer

It is a heavy vehicle with a large blade in the front, used for pushing the earth and stones away and for making the ground flat at the same time. A bulldozer is equipped with a heavy metal plate (blade) to push large quantities of soil, sand, rubble and other such material during construction or conversion work.

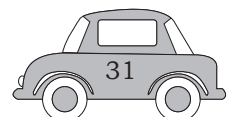

Bulldozers (Fig. 2.11) are generally used at sites like mines and quarries, military bases, heavy industry factories, engineering projects and farms.



Fig. 2.11: Bulldozer

Typically, bulldozers are large and powerful tracked heavy equipment. The tracks give them excellent ground hold and mobility through very rough terrains. Bulldozers have great ground hold and a torque divider that is designed to convert the power of the engine into dragging ability, which allows it to use its own weight to push heavy objects and even remove things from the ground. The Caterpillar D9, for example, can easily tow

tanks that weigh more than 70 tonnes. Because of these attributes, bulldozers are used to clear areas of obstacles, shrubbery, burnt vehicles and remains of structures. The bulldozer's primary tools are the blade and the ripper.

Road Roller

Road Roller or soil compactor (Fig. 2.12) is a type of engineering vehicle used to compact soil, gravel, concrete or asphalt in the construction of roads and foundation. Similar rollers are used at landfills or in agriculture. A road roller is used for making roads. It uses the weight



Fig.2.12: Road roller

of the vehicle to compress the surface being rolled (static) or uses mechanical advantage (vibrating). Initial compaction of the substrate on a road project is done using a pad foot drum roller, which achieves higher compaction density due to the pads having less surface area. On large roads, a four-wheel compactor with pad foot drum and a blade is used due to its heavyweight, speed and the powerful pushing force to spread bulk material.

Dumper

It is a four-wheeled heavy machine vehicle (Fig. 2.13) designed for carrying bulk material or transporting loose material at construction sites. It is also known as a dump truck. Dumpers are operated by diesel engine. In a dumper truck, chassis with a dump body is mounted to the frame. The bed is raised by a vertical hydraulic ram mounted under the front of the body, or a horizontal hydraulic ram and lever arrangement between the frame rails, and the back of the bed is hinged at the back of the truck.



Fig 2.13: Dumper

Dumpers are also known as tippers. As per the need and requirement, various types of dumper are being manufactured in the country. The cost of these dumpers varies as per size.



Fig.2.14: Excavator (JCB)

Excavator

Excavator (Fig. 2.14) is the machine that can excavate the soil of various types forcefully and then using hydraulic system a hydraulic force is generated and utilising this force bucket is pulled back towards the machine. The bucket of excavator is replaceable. If the front bucket is exchanged with some other attachments, for example, pile diver, hydraulic jack hammer, etc., then the excavator can be used for multiple purposes. Excavator

comes in numerous sizes depending on bucket size, length of boom, length of arm and operation speed. The performance of an excavator can be measured from the production cycle. Production cycle is the time that an excavator takes to load the bucket from source, swing, dump, return back and then dig again. Therefore, faster the operation speed, the faster one cycle will complete and hence production cycle will increase.

Practical Exercises

Activity 1

List the construction equipment vehicles you have seen at any construction site.

S.No.	Name of model

Check Your Progress

A. Fill in the blanks

1. A road roller is a _____ type engineering vehicle used to compact soil, gravel, _____ or asphalt in the _____ of roads and foundations.
2. Dumper is a vehicle designed for carrying _____.
3. Dumper is a _____ vehicle.
4. An excavator is used for _____.
5. Modern dumpers have payloads of up to _____.

B. Multiple choice questions

1. Bulldozer is known as _____.
 - (a) crawler
 - (b) bunker
 - (c) road roller
 - (d) CB
2. Dumpers are also known as _____.
 - (a) heavy equipment
 - (b) tippers
 - (c) passenger vehicle
 - (d) carts

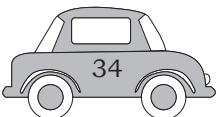

3. Which of these is not construction equipment?

- (a) Dumpers
- (b) Dozers
- (c) Jeep
- (d) Road rollers

4. Road roller is used for _____.

- (a) lifting the soil
- (b) levelling the road
- (c) carrying bulk material
- (d) None of the above

C. Short answer questions

1. List the different types of construction equipment vehicles.
2. Differentiate between road roller and dumper.

SESSION 5: SPECIAL VEHICLES

In the previous sessions, we have covered passenger vehicles, commercial vehicles, agricultural vehicles and construction equipment vehicles. Automotive technology has several other applications also, some of which we shall discuss in this session.

Railway locomotive is basically an automobile, but much bigger than a car, bus or a truck. In the beginning, trains were pulled by locomotives which were powered by steam. Nowadays, most rail engines (Fig. 2.15) run on diesel or electricity. In India, rail is a very important means of transportation of goods and passengers. As you know, a train cannot run on roads but runs on a railway track (see Fig. 2.16).

Another application of automotive technology are the big machines which have long extended arms for reaching high-rise buildings or the top of electric poles. These are mounted on an automobile and the complete machine is called a crane. Sometimes, the traffic police use a crane to lift cars which are wrongly parked.



Fig.2.15: Train engine



Fig.2.16: Railway track



Fig.2.17: Forklift



Fig. 2.18: Milk tanker

Another interesting application of an automobile is the forklift (Fig. 2.17). A forklift is used mostly in industry and in large warehouses for carrying components and goods within the premises of the factory or the godown or warehouse. So, a forklift is normally used for carrying goods for very short distances within the four walls of a building but never on the outside road.

Tankers are also one of the automobile applications, which (Fig. 2.18) are used when liquids like water, milk, oil, petrol, diesel, etc., are required to be transported to long distances. These tankers have very big cylinders mounted horizontally on the chassis of a specially built automobile. The capacity of these tankers can vary.

Sometimes, a warning sign 'flammable material' is written on the tankers that carry volatile fluids like petrol and diesel. This warning is to caution people on the road to not bring any ignited object like matchstick or firecrackers near the tanker. Petrol and diesel can catch fire very easily since their flash point is very low and if there is any source of intense heat or ignited objects, the tanker can catch fire and cause a lot of damage.

It may be noted that sometimes these tankers are also mounted on railway trains. Also, you may have seen pictures of tankers on a ship. Similarly on roads, trailers are used for carrying heavy materials or containers (Fig. 2.19).

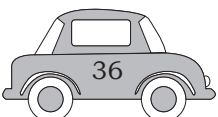



Fig.2.19: Trailer

Practical Exercises

Activity 1

List the models of special vehicle that you have seen in your locality.

S. No.	Name of model

Check Your Progress

A. Fill in the blanks

1. A train is pulled by _____.
2. Rail engines run on _____ or _____.
3. The crane is a _____ vehicle.
4. When liquids like water, milk, oil, petrol, diesel, etc., are required to be transported to _____ distances, it is done in _____.
5. The tanker vehicle is used for carrying _____.

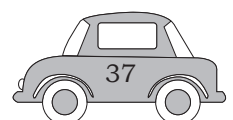

B. Multiple choice questions

1. In earlier times trains were pulled by_____.
(a) locomotives (b) car
(c) motorcycle (d) None of these
2. Tanker is used for carrying _____.
(a) liquid (b) water
(c) milk(d) (d) All of these
3. Rail is used for carrying _____.
(a) passengers (b) goods
(c) water (d) All of these
4. Which machine does the traffic police use for lifting cars?
(a) crane (b) dumper
(c) road roller (d) None of these

C. Short answer questions

1. Define the role of special vehicles.
2. What is the purpose of using cranes?

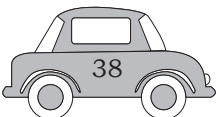

AUTOMOTIVE SERVICE TECHNICIAN - CLASS 9

UNIT 2 : VARIOUS TYPES OF AUTOMOBILES

SESSION 1: TWO-WHEELERS AND THREE-WHEELERS

Check Your Progress

A. Fill in the blanks

1. A two-wheeler refers to _____ that run on two wheels.
2. A motorcycle is a motor-powered _____, similar in construction to a bicycle.
3. A three-wheeler is a vehicle with _____ either 'human or people-powered vehicles' (HPV or PPV) or motored vehicles in the form of a _____ or automobile.
4. Autorickshaws are _____ all over India, and provide cheap and efficient _____.
5. New autorickshaws run on _____ and are environment-friendly.

B. Multiple choice questions

1. What is the typical mileage of an Indian-made autorickshaw per liter of petrol?
(a) 25 km (b) 30 km
(c) 35 km (d) 40km
2. Trikes-based machines are fitted in _____.
(a) 2-wheelers (b) 3-wheelers
(c) 4-wheelers (d) None of these
3. Two-and three-wheelers are run by a common fuel known as _____.
(a) Petrol (b) Diesel
(c) CNG (d) All of these

C. Short answer questions

1. Differentiate between two-wheelers and three-wheelers.
2. List the uses of three-wheelers.

SESSION 2: PASSENGER VEHICLES AND COMMERCIAL VEHICLES

Check Your Progress

A. Fill in the blanks

1. A passenger vehicle refers to a machine that runs on _____ wheels.
2. Trucks are used for carrying _____ in bulk.
3. _____ produced the first jeep.
4. A commercial vehicle is used for _____.

C. Short answer questions

1. Who invented the jeep?
2. Differentiate between passenger and commercial vehicles.
3. Discuss the importance of transport vehicle in India.

SESSION 3: AGRICULTURAL VEHICLES

Check Your Progress

A. Fill in the blanks

1. Agricultural _____ may be towed behind or mounted on the tractor.
2. An agricultural vehicle is a farm vehicle that provides _____ and traction to _____ agricultural tasks.
3. Combines are used for _____ and _____.
4. Combines are one of the most economically important _____ inventions.

B. Short answer questions

1. What are the uses of a tractor?
2. How have agricultural vehicles helped the farmers in India?

SESSION 4: CONSTRUCTION EQUIPMENT VEHICLES

Check Your Progress

A. Fill in the blanks

1. A road roller is a _____ type engineering vehicle used to compact soil, gravel, _____ or asphalt in the _____ of roads and foundations.
2. Dumper is a vehicle designed for carrying _____.
3. Dumper is a _____ vehicle.
4. An excavator is used for _____.
5. Modern dumpers have payloads of up to _____.

B. Multiple choice questions

1. Bulldozer is known as _____.
(a) crawler
(b) bunker
(c) road roller
(d) CB
2. Dumpers are also known as _____.
(a) heavy equipment
(b) tippers
(c) passenger vehicle
(d) carts
3. Which of these is not construction equipment?
(a) Dumpers
(b) Dozers
(c) Jeep
(d) Road rollers
4. Road roller is used for _____.
(a) lifting the soil
(b) levelling the road
(c) carrying bulk material
(d) None of the above

C. Short answer questions

1. List the different types of construction equipment vehicles.
2. Differentiate between road roller and dumper.

SESSION 5: SPECIAL VEHICLES

Check Your Progress

A. Fill in the blanks

1. A train is pulled by _____.
2. Rail engines run on _____ or _____.
3. The crane is a _____ vehicle.
4. When liquids like water, milk, oil, petrol, diesel, etc., are required to be transported to _____ distances, it is done in _____.
5. The tanker vehicle is used for carrying _____.

B. Multiple choice questions

1. In earlier times trains were pulled by _____.
(a) locomotives (b) car
(c) motorcycle (d) None of these
2. Tanker is used for carrying _____.
(a) liquid (b) water
(c) milk(d) (d) All of these
3. Rail is used for carrying _____.
(a) passengers (b) goods
(c) water (d) All of these
4. Which machine does the traffic police use for lifting cars?
(a) crane (b) dumper
(c) road roller (d) None of these

C. Short answer questions

1. Define the role of special vehicles.
2. What is the purpose of using cranes?



Major Systems and Components of an Automobile

INTRODUCTION

In the previous Units, we learnt about the different types of automobile. In this Unit, we will discuss the major systems and components of an automobile. An automobile is made of several components, assemblies and systems. The growing automotive industry has given rise to a growing auto component industry also. India has emerged as a global outsourcing hub for manufacturing of various automobile components. All major companies like Toyota, Hyundai, Ford, Volvo, Renault and others are now sourcing their automotive components from Indian manufacturers.

The auto components industry is predominantly divided into five segments.

- (i) Engine parts
- (ii) Drive transmission and steering parts
- (iii) Suspension and brake parts
- (iv) Electrical parts
- (v) Body and chassis



17969CH03

Global automobile manufacturers see India as a manufacturing hub for auto components due to the following reasons:

- (i) Low-cost labour force and availability of raw material which makes India cost competitive
- (ii) An established manufacturing base in India
- (iii) Setting up of the operations of major international auto components including Delphi, Visteon, Bosch and Meritor in India
- (iv) Setting up of International Purchasing Offices (IPOs) of automobile manufacturers and auto component manufacturers in India
- (v) Fine-quality components manufactured in India
- (vi) India being a global hub for research and development (R&D), General Motors, Daimler Chrysler, Bosch, Suzuki, Johnson Controls, etc., have their research centres in India

In this Unit, you will learn about the various components and systems that make a complete automobile—the engine and its parts, the body and chassis, drive transmission and steering parts, suspension and brake parts, electrical parts and other systems that make running an automobile possible.

SESSION 1: CHASSIS AND AUTO BODY



Fig. 3.1: Chassis with suspension and exhaust system

Chassis

Chassis is a French term and was initially used to denote the frame or main structure of a vehicle. The chassis (Fig. 3.1) contains all the major units necessary to propel the vehicle, guide its motion, stop it and allow it to run smoothly over uneven surfaces. It is the main mounting for all the components including the body. It is also known as the carrying unit.

The chassis includes the following major components.

- (i) A steel frame, which is a major part.
- (ii) In case of a passenger car, the whole body is also an integral part of the chassis. However, in commercial vehicles like trucks and buses, the body is not a part of the chassis. Therefore, a chassis is almost a complete vehicle except the

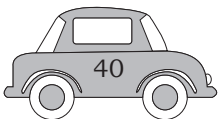

body and other accessories, which are not involved in the movement of the vehicle.

- (iii) Other major components include engine, transmission system, front and rear axle, steering system, suspension system, wheels, tyres and brakes.

Functions of the chassis

The functions of the chassis includes

- (i) carrying the weight of the vehicle and its passengers,
- (ii) withstanding the engine and transmission torque and thrust stresses, as well as accelerating and braking torque,
- (iii) withstanding the centrifugal force while taking a turn and
- (iv) withstanding the bending load and twisting due to the rise and fall of the front and rear axles.

Automobile Body or Superstructure

In case of integral or frameless construction, the body is an integral part of the chassis. But, in case of the conventional chassis, the body or superstructure is made after receiving the chassis from the manufacturer. The shape of the body depends upon the ultimate use for which the vehicle is meant.

The body of a car (Fig. 3.2) is made of a sheet of metal or fibre glass, so that passengers can sit in it. To make

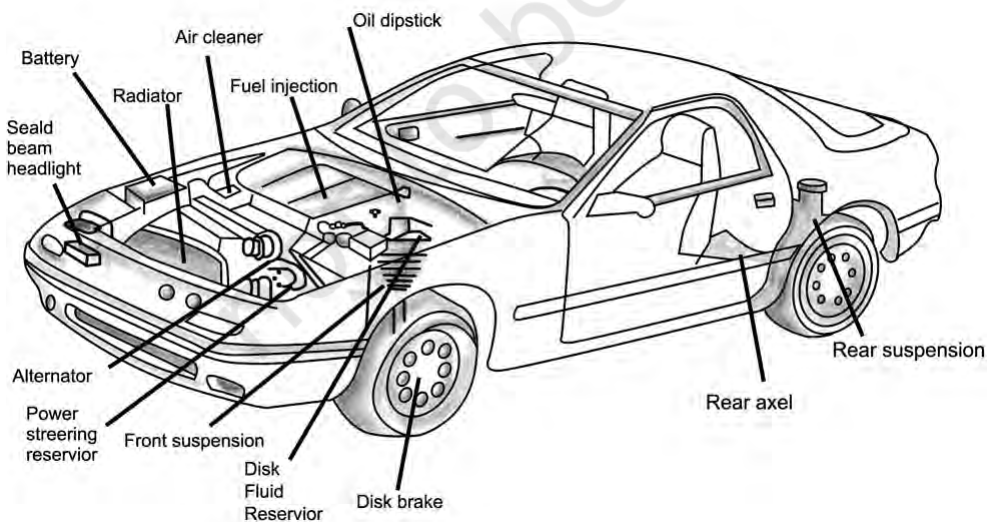

Fig. 3.2: Body of a car

the journey comfortable, cushioned seats are provided. The body is provided on all sides with glass panes fixed to protect the passengers from dust and rain.

The body of a bus is made of metal, like

- (a) steel section pillars with steel sheet panelling,
- (b) steel section pillars with aluminium panelling and
- (c) all aluminium bodies, i.e., pillars, framework and panelling made of aluminium sections and sheets. This is because aluminium is very light in weight compared to steel.

The body of a truck has the driver's compartment covered and the rest is kept open. Such bodies are usually called load bodies. In most of the cases, it is an open body, whereas for liquid material like water, milk and fuel products, a tank is mounted on the chassis. The body is fixed to the chassis with the help of I- or U-bolts with rubber packing placed between the chassis and body cross members.

Requirements of automobile body

The body of a motor vehicle should fulfill certain requirements. It should

- (i) be light weight.
- (ii) have minimum number of components.
- (iii) have long fatigue life.
- (iv) have uniformly distributed load.
- (v) have sufficient space for passengers and luggage.
- (vi) have good access to the engine and suspension system.
- (vii) have minimum vibrations when the vehicle is running.
- (viii) have minimum resistance to air.
- (ix) be cheap and easy in manufacturing.
- (x) have clear all-round vision through glass areas.
- (xi) have an attractive shape and colour.

Check Your Progress

A. Fill in the blanks

1. A chassis is almost a complete _____ mounting body.
2. The shape of the chassis depends _____ upon the ultimate use of the _____.

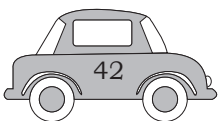

3. Major part of a chassis is the _____ frame.
4. In commercial vehicles like trucks and buses the body is not a _____ of the chassis.
5. In most of the cases, it is an open body, whereas for liquid material like water, milk and fuel a _____ is mounted on the chassis.

B. Multiple choice questions

1. Chassis is a French term and was initially used to denote _____.
 - (a) main structure of a vehicle
 - (b) fixing the automobile body
 - (c) transmission system, front and rear axle
 - (d) carrying the bolt
2. What are the functions of the chassis frame?
 - (a) To carry the weight of the vehicle and its passengers.
 - (b) To withstand the engine and transmission torque.
 - (c) To withstand the centrifugal force while cornering.
 - (d) All of the above
3. Automobile body is made of _____.
 - (a) sheet metal or fibre glass
 - (b) iron
 - (c) copper
 - (d) gun metal
4. The body is fixed to the chassis with the help of _____.
 - (a) I or U bolts
 - (b) rivet
 - (c) welding
 - (d) threaded bolt
5. Automobile body should fulfill which of the following requirements?
 - (a) The body should be light.
 - (b) It should have a long fatigue life.
 - (c) Both (a) and (b)
 - (d) None of the above

C. Short answer questions

1. Differentiate between chassis frame and automobile body.
2. Explain the use of the chassis frame.
3. How does auto body help in transport?

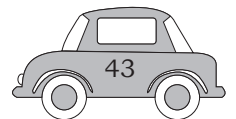

SESSION 2: ENGINE AND ITS COMPONENTS

An engine (Fig. 3.3) is complex unit in which different components are assembled together, and fuel is burned to produce power or energy. The engine converts chemical energy (heat energy) into mechanical energy, which is then utilised for vehicular movement. There are different processes of fuel combustion. When the fuel is burned within the engine, it is called an Internal Combustion (IC) engine, and when it is burned externally and the produced steam is used for the mechanical movement, it is called an External Combustion (EC) engine. Nowadays, automobile engines are quite economical due to the developments taking place in the field of internal combustion engine.

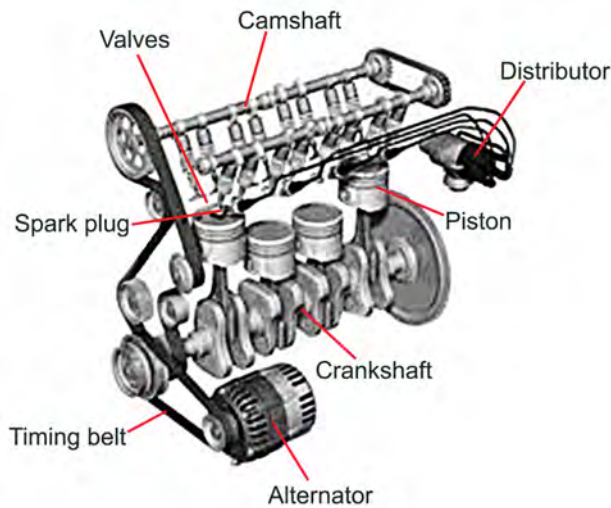

Fig. 3.3: Engine

On the basis of the process of ignition, the automobile engines are classified into spark ignition engine (petrol or gas) and compression ignition engine (diesel). In an IC engine, the reciprocating motion of the piston is converted into rotary motion of the crankshaft and the produced power is then transmitted to move the vehicle. In case of a rotary engine or Wankel engine, the rotor rotates and completes the process of combustion and produces the power, which helps the vehicular movement.

The spark ignition engine can be differentiated from the compression ignition engine as per the following factors.

- (i) The type of fuel used.
- (ii) The way the fuel enters in the combustion chamber.
- (iii) The way in which fuel is ignited.

Spark Ignition Engine (Petrol or Gas Engine)

The spark ignition engine uses a highly volatile fuel, such as gasoline, which turns into vapour easily. The fuel is mixed with air before it enters in the combustion chamber, and forms a combustible air-fuel mixture. This mixture then enters the cylinder and gets

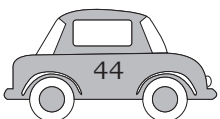

compressed with the help of a piston. An electric spark is produced by the ignition system which ignites the combustible air-fuel mixture. The combustible gases burn and expand, which forces the piston downwards for generating power.

Compression Ignition Engine (Diesel Engine)

In the compression ignition engine or diesel engine, only fresh air enters the cylinder, which is compressed to a very high pressure and temperature, which could go up to 1000°F (538°C). The diesel is then injected or sprayed into the engine combustion chamber. This spray contains very fine and tiny particles of diesel in an atomised form. The hot air or heat of compression ignites the fuel and generates the power stroke.

Components of an IC Engine

1. Cylinder: The cylinder or cylinder liner of an IC engine is fitted in the cylinder block, which is a single casted unit and is considered to be the main body of an engine. The block has cylinder liners. The piston reciprocates up and down from Top Dead Centre (TDC) to Bottom Dead Centre (BDC) to generate power.

The cylinder liner and the cylinder block have to withstand very high pressure (about 70 bar) and temperature (about 700°C) during power stroke. The material used for the cylinder block must withstand such heat and also disperse it effectively. The cylinder block is well-designed with water passages to remove the excess heat and separate oil passages are provided for the circulation of lubricating oil. The top portion of the cylinder block is covered by the cylinder head. The crankcase is an integral part of the cylinder block which houses the crankshaft and the lower portion is dipped in an oil pan.

Nowadays, cylinder liners are made of special alloy and internal portion is coated with material like titanium which provides mirror finish and can withstand the wear resistance. The upper end of

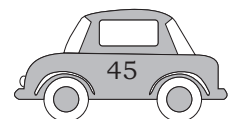

the cylinder liner has a flange which fits well in the cylinder block. The exterior portion of the cylinder liner is exposed to water jacket for easy dispersion of heat.

2. Cylinder Head: The cylinder head is also single-casted unit and bolted to the top portion of the cylinder block. The combustion chamber is a part of the cylinder head, where the combustion of gases takes place. The water passages are provided to remove the heat from the cylinder head. In latest engines, the cylinder head also houses the camshaft which has the inlet and exhaust valves with supportive valve mechanism. This provision is made to fix spark plug in SI engines and nozzle in CI engines. The lower portion of the cylinder head is well-machined to ensure there is no leakage of gases. Cylinder head gasket is usually cast as one piece and bolted to the top of the cylinder (engine block). Copper and asbestos gaskets are provided between the cylinder and cylinder-head to obtain a gas-tight joint. The charge enters the combustion chamber through the inlet valve connected to the inlet manifold, and the exhaust gases are removed through the exhaust valves connected to the exhaust manifold.

3. Piston and Piston Rings: Piston is a cylindrical unit, used to compress the charge during compression stroke and to transmit the gas force to the connecting rod and then to the crankshaft during power stroke. The pistons of IC engines are usually made of aluminium alloy, which has high thermal conductivity and is light in weight. The material of piston must have the ability for higher heat transfer. The piston moves up and down (from TDC to BDC) and assists in completing the engine cycle.

The piston rings are placed in the ring groove and provide sealing between the piston and the cylinder liner, thereby preventing the leakage of high pressure gases. These are made of special grade cast iron, which retains its elastic property even at very high temperature. The upper piston rings are called the compression rings and the lower piston rings are called the oiling or oil control rings.

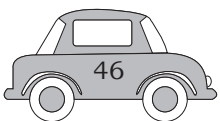

4. Connecting Rod: It is usually manufactured by using drop-forged steel. It is made in the shape of 'I' so as to reduce its weight and to withstand strength. Its small end is connected to the piston with the help of gudgeon pin and the big end is connected to the crankpin with shell bearings. It has a passage for the transfer of lubricating oil from the big end bearing to the small end bearing (gudgeon pin). The major function of the connecting rod is to convert the reciprocating motion of piston to the rotary motion of the crankshaft.

5. Crank and Crankshaft: The crankshaft (Fig. 3.4) is called the backbone of an engine because it converts the reciprocating motion of piston into the rotary motion of the crankshaft. The crankshaft is a single casted unit and is made of drop-forged steel main journals which are placed and supported in the crank case. The main journal and connecting journals are machined to a smooth finish to reduce

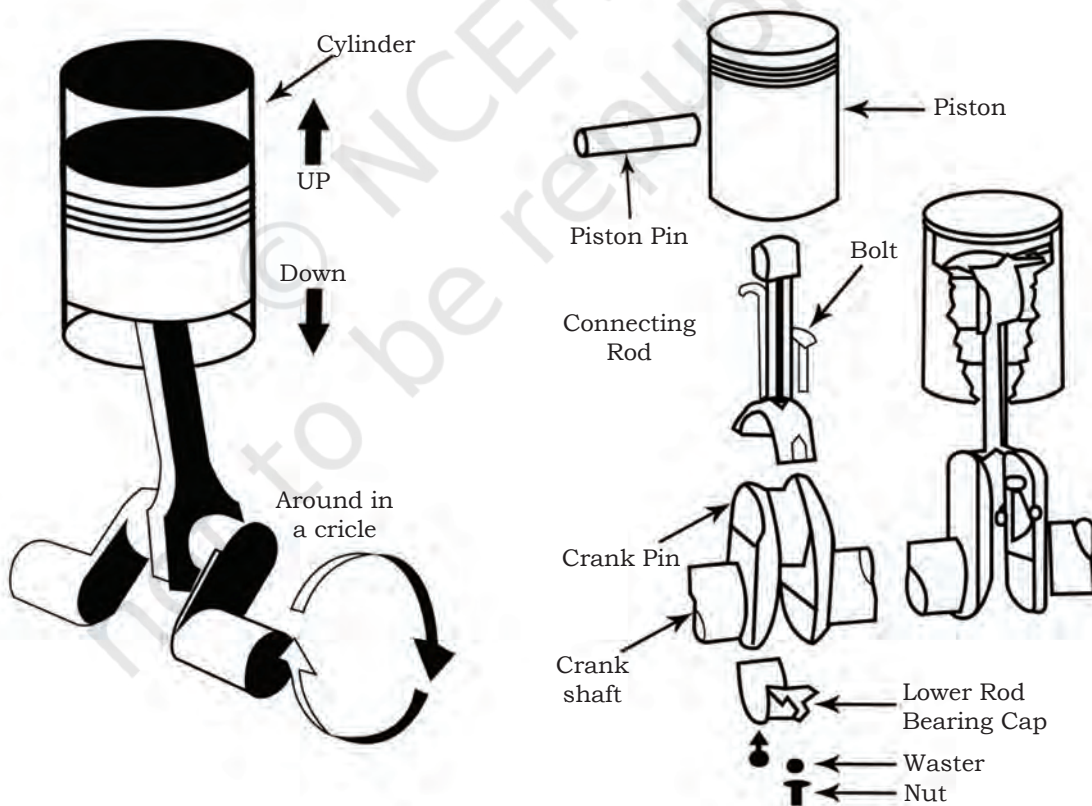

Fig. 3.4: Crankshaft of multicylinder engine

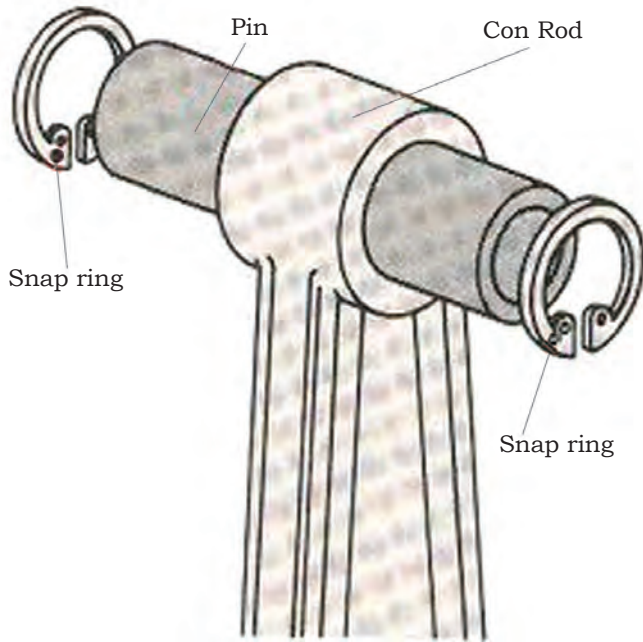

Fig. 3.5: Crank assembly of single cylinder engine

friction and shell bearings are used for smooth rotation of crankshaft. Front end of the crankshaft will transmit drive to the camshaft and also to the timing gear, whereas the flywheel is bolted to the flange at rear end of the crankshaft. Main journal of the crankshaft carries the oil passages to lubricate shell bearings.

In case of a single cylinder engine crank assembly (Fig. 3.5) is used, two crank webs are connected with the crank pin, and crank webs shafts are press fitted in both. At one side of the shaft magneto is fastened whereas clutch assembly is mounted to the other. The crank assembly is balanced dynamically

as well as statically for the smooth transmission of power.

6. Piston Pin or Gudgeon Pin. This unit connects the piston and small end of the connecting rod and passes through the piston (Fig. 3.6). Circlips

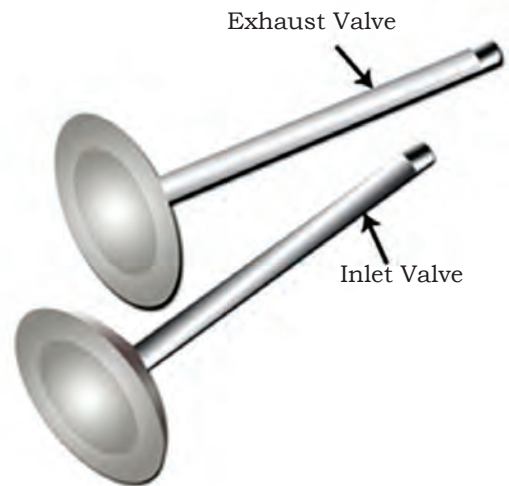
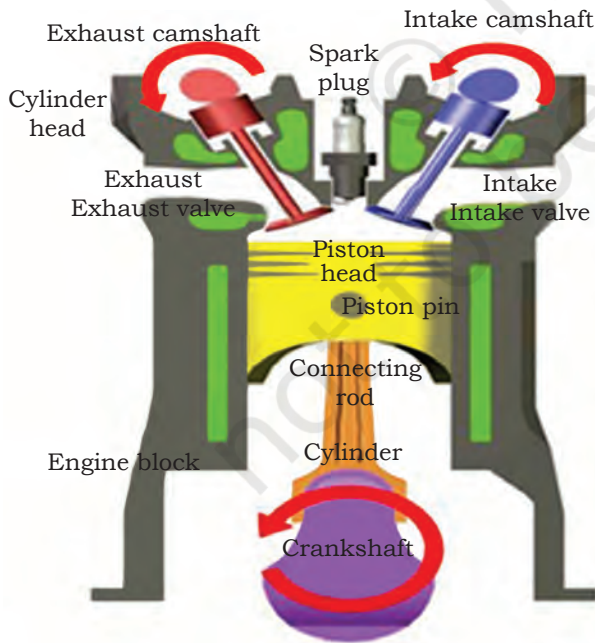
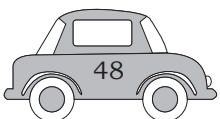

Fig. 3.6: Important components of piston



are fitted into recesses in the piston to prevent the gudgeon from touching the cylinder wall. The needle bearing or bronze bushing is press fitted into the connecting rod, due to this the gudgeon pin provides bearing for the oscillating small end of the connecting rod.

7. Inlet Valve: The major role of the inlet valve is to submit fresh charge in to the cylinder during the suction stroke. Opening and closing of the valve will control the admission of the charge into the petrol engine or air into diesel engine during suction stroke of an engine. The valve operations will be as per the valve timings. The inlet valve has a wider face or in latest engines two inlet valves are used to maintain volumetric efficiency of an engine.

8. Exhaust Valve: The exhaust valve removes out the burnt gases from the combustion chamber after power stroke. The exhaust valve has to bare more heat resistance.

9. Valve Spring: The valve spring (Fig. 3.7) plays an important role to close the valve and also provides air tight compartment to seal the combustible gases during power stroke and also maintain the self-centering movement of the valve. Both ends of the vale spring are machined for smooth function and up and down movements of the valves.

10. Inlet Manifold: The fuel air mixture is carried from the carburettor to the cylinder through a separate pipe through inlet manifold in a carbureted engine. Whereas in compression ignition engines (diesel), the air is sucked through the induction manifold. In M.P.F.I the engine holds the throttle body on top of the manifold and the supply of air is monitored by the throttle body sensor.

11. Exhaust Manifold: It is a set of pipes and muffler, which is used to remove the exhaust gases from the exhaust ports. Engines oxygen sensors and catalic convertors are used to reduce sound and air pollution, respectively (see Fig. 3.8).



Fig 3.7: Valve Spring

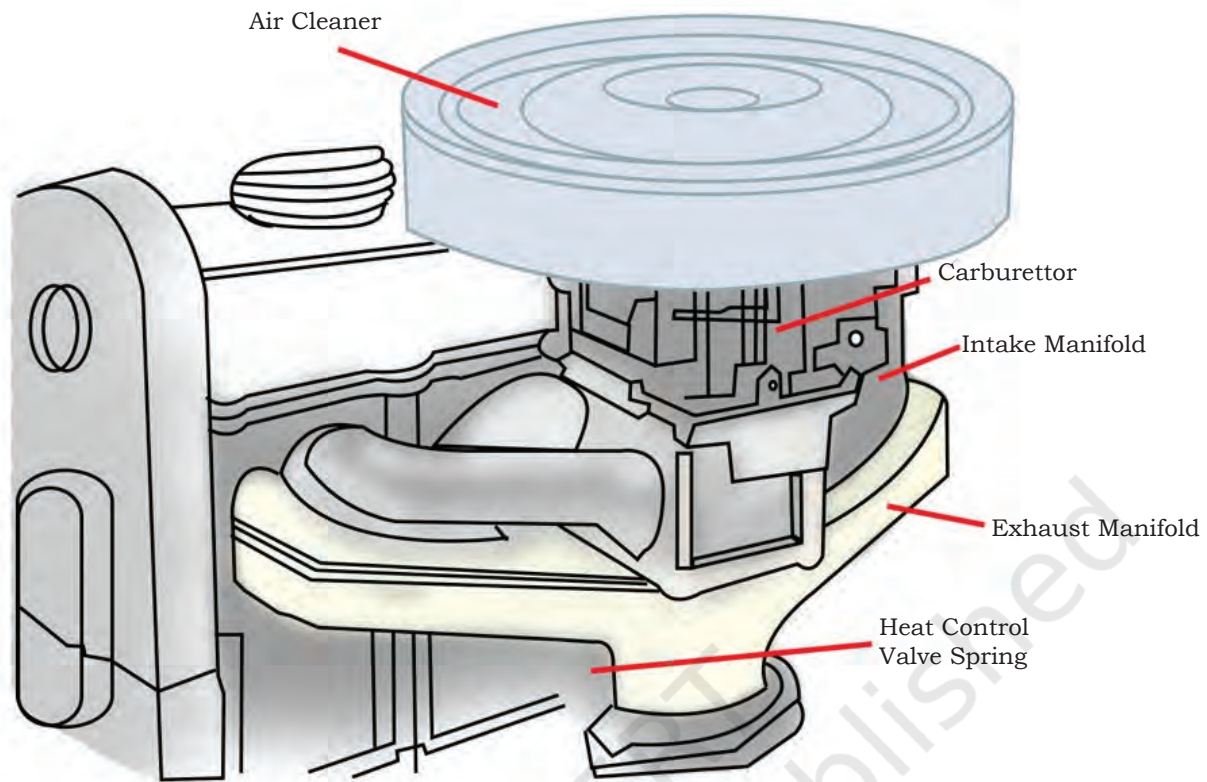

Fig. 3.8: Exhaust Manifold

12. Camshaft: The major function of the camshaft is to operate the intake and exhaust valves through the cam lobe, the gear drive transmits the power for the rotation of oil pump, therefore the oil pump sucks the oil from the oil sump and transmits the same to the oil gallery. The camshaft (Fig. 3.9) is driven by crankshaft at half the speed of the crankshaft.

13. Cam Lobe and Tappet: The cam lobe (see Fig. 3.10) of the camshaft is placed directly above the bucket tappet, such that the lobe comes around it and pushes down the bucket tappet and the valve, thus opening the valve. In an overhead camshaft with rocker arm, the cam lobe comes under the valve lifter, and causes the rocker arm to rock or turn the lobe and pushes down the valve stem and it moves down to open. When the cam lobe passes the valve lifter the valve spring retains back to the original



Fig. 3.9: Camshaft

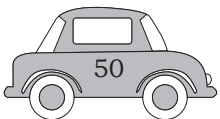

length. To close the valve the rocker arm turns back and the valve lifter is pushed down on the cam. In case of double overhead camshaft engine, the double row valves are usually operated by the separate overhead camshaft.

14. Push Rod and Rocker Arm: The motion of the cam lobe pushes the valve lifter upwards. This movement pushes the push rod (Fig. 3.11) and the rocker turns the upward motion of the push rod to the downward movement of the valve stem resulting in opening of the valve.

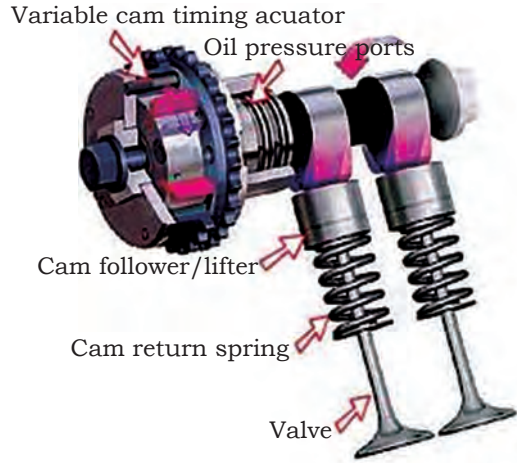

Fig. 3.10: Cam Lobe and Tappet

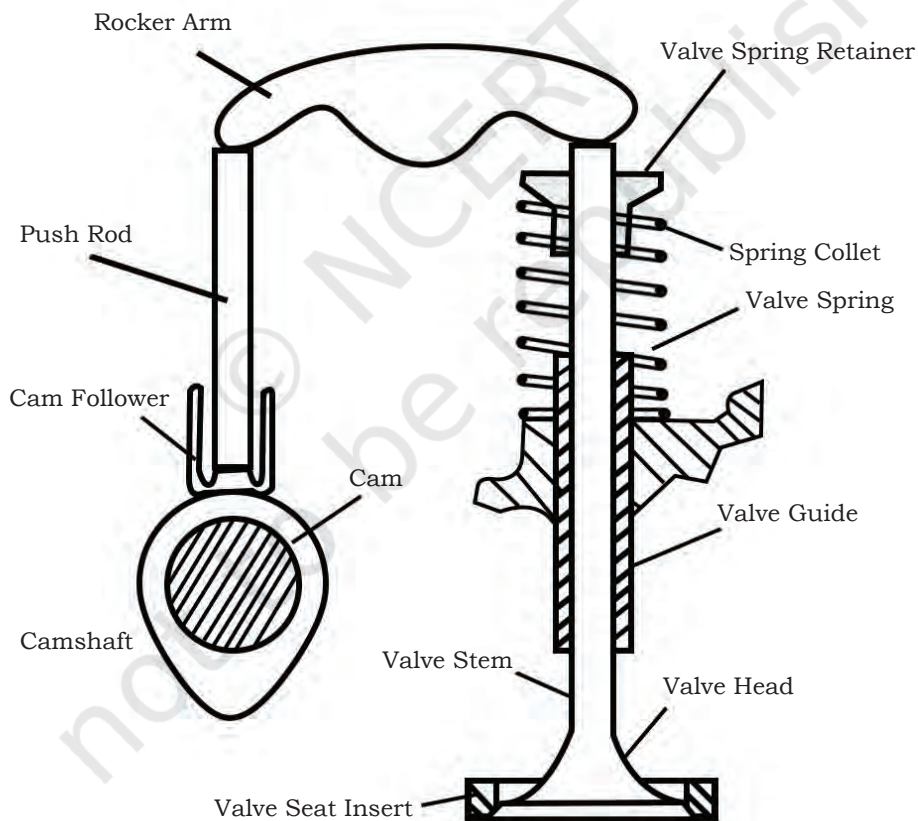

Fig. 3.11: Push Rod and Rocker Arm



Fig. 3.12: Crank Case

15. Crank Case: The crank case is an integrated part of the cylinder block. The casing is provided to hold the crankshaft. The crankshaft is allowed to rotate freely and transmit the power to the flywheel (Fig. 3.12).

16. Water Pump and Water Jacket: The function of water pump is to draw water from the radiator and supply it to the water passages provided in

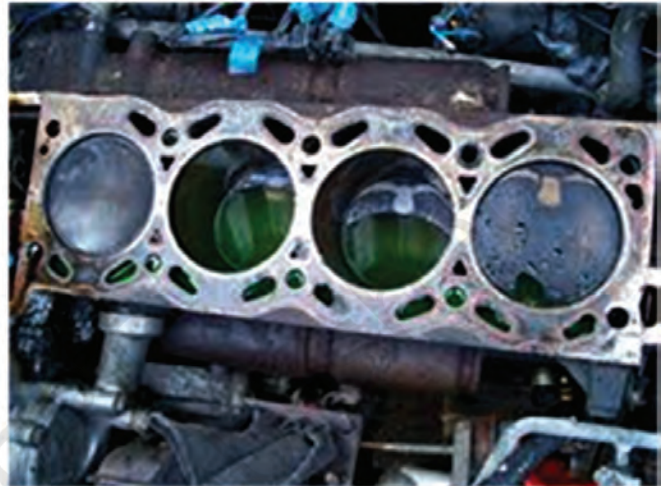

Fig. 3.13: Water Pump and Jacket

the cylinder block and cylinder head with certain pressure. The circulation of coolant removes the excessive heat from an engine. This helps in maintaining the engine temperature and also the life of an engine (Fig. 3.13).

17. Radiator: The major function of the radiator is to radiate the heat from the coolants. It has two tanks located at the top and bottom. The upper tank is connected to the lower tank with the core through the passages for easy radiation of the heat. The radiator also stores the coolant (Fig. 3.14).



Fig 3.14: Radiator

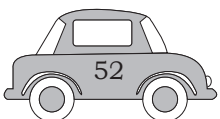

18. Flywheel: It is a wheel mounted on the crankshaft which stores the energy during the power stroke and transmits the energy to the transmission system, the clutch and then to the gear box (Fig. 3.15).

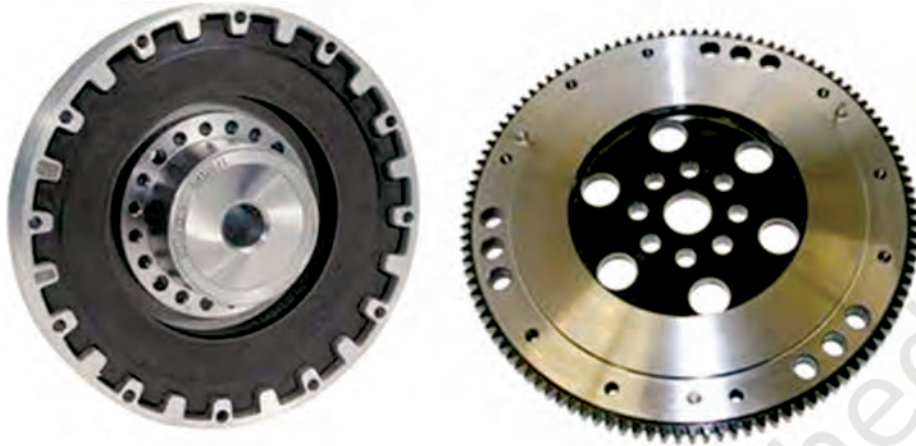

Fig. 3.15: Fly wheel

19. Governor: It is run by drive from the crankshaft. The function of the governor (Fig. 3.16) is to regulate the charge in case of petrol engine and

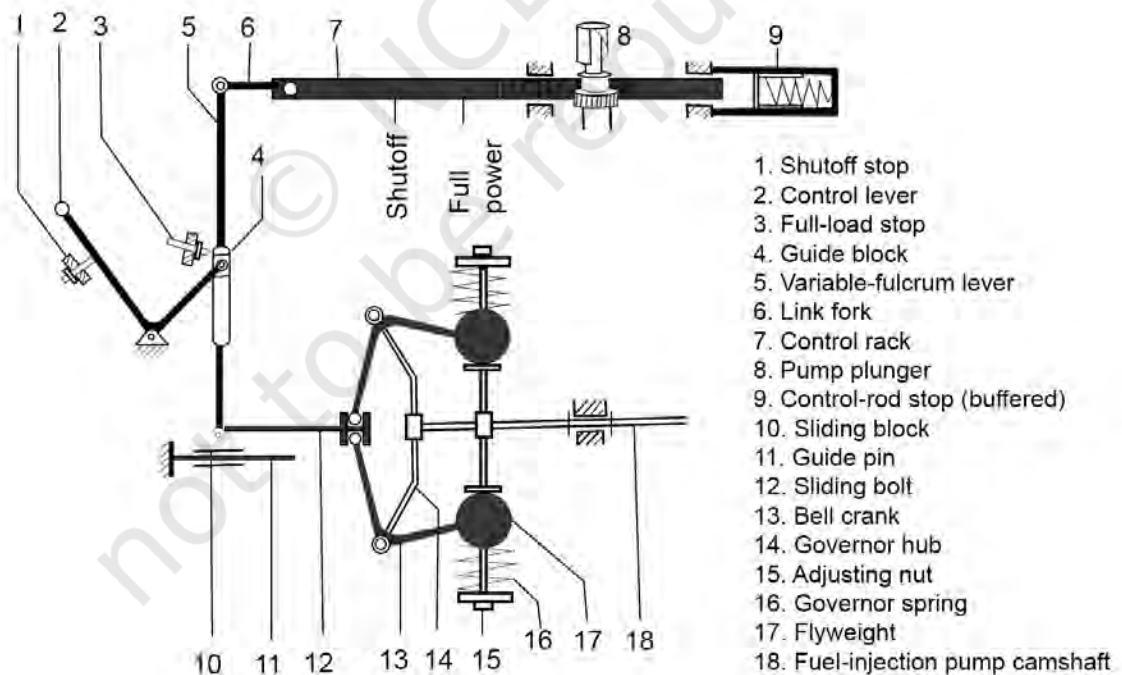

Fig. 3.16: Governor

amount of fuel in case of diesel engine to maintain the speed of the engine constant, when the load requirement varies.

The components described above are commonly used for all types of IC engine. Here we are describing only a few components which are used in particular types of engines.

20. Carburettor: The major function of the carburetor (Fig. 3.17) is to supply carburised fuel as per speed and the engine load. In petrol engines the carburetor is mounted on the induction pipe or on the induction manifold. The quantity of fuel air mixture in appropriate ratio is controlled by the throttle valve and the movements of the throttle valve are connected to the accelerator.

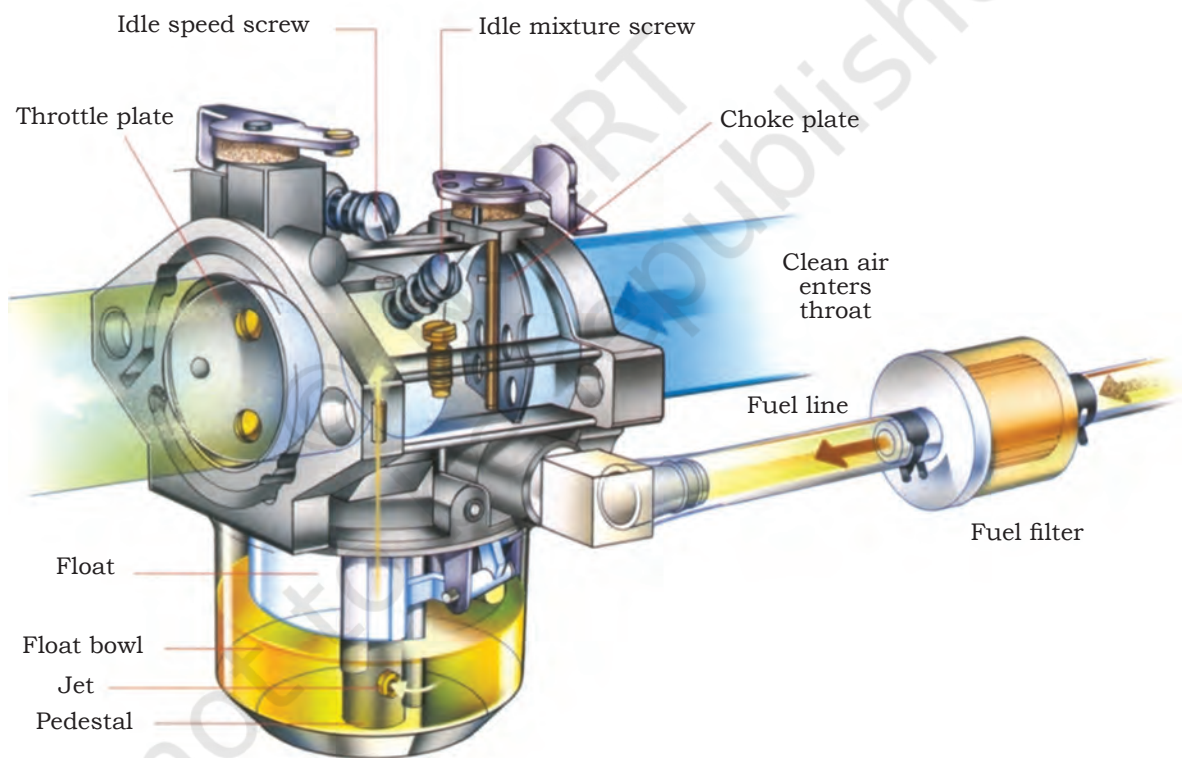
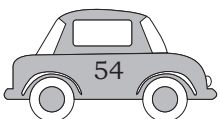

Fig 3.17: Carburettor

21. Spark Plug: The function of the spark plug is to ignite the fuel air mixture after completion of the compression stroke in an engine. It is generally



placed in the combustion chamber of the cylinder head. This is only used in petrol engine (Fig. 3.18).

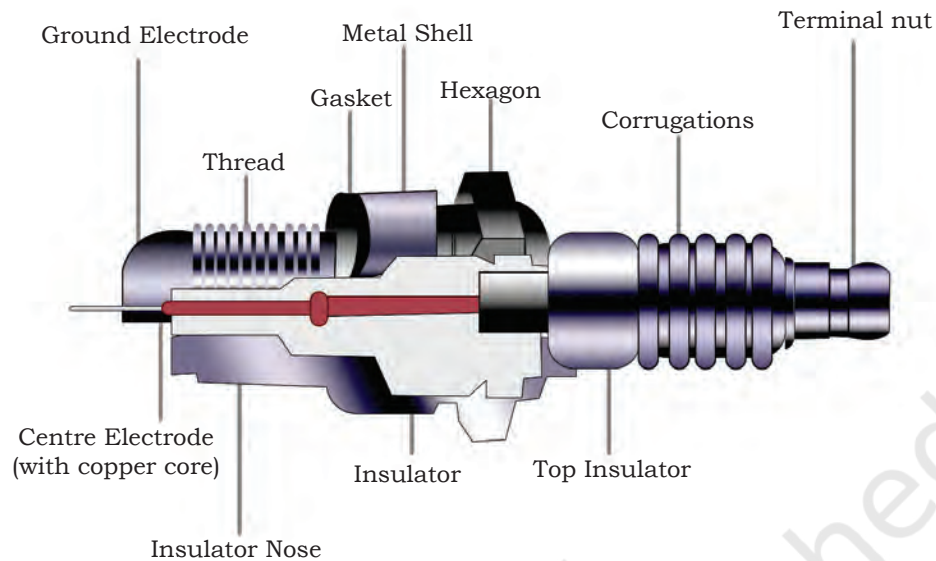

Fig. 3.18: Spark Plug

22. Fuel Injection Pump: In case of diesel engine the diesel oil from the fuel tank is sucked by the fuel feed pump. The pump first sends the diesel oil to the fuel filter and then to the transfer pump. The transfer pump increase the pressure of the fuel.

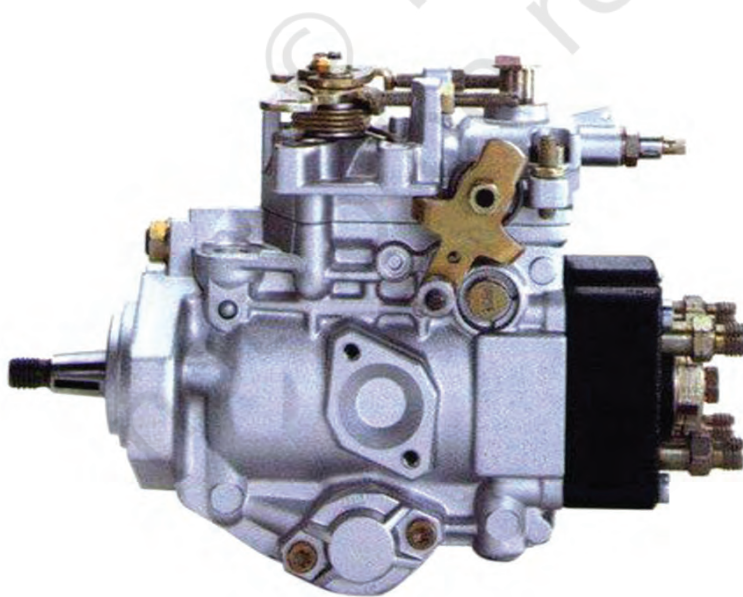

Fig. 3.19: Fuel Injection Pump

The high pressure of fuel is then sent to the distributor rotor through the metering valve and from rotor the fuel is sent to the injector (Fig. 3.19). In case of a multi point fuel injection system, the electric fuel pump is used and placed in the fuel tank. The pump generates the injection pressure and sends it to the fuel filter, and then to the common rail at a pressure of 3 to 4 bar. The common rail or fuel rail is connected to the fuel injector.

23. Fuel Injector: The function of fuel injector (Fig. 3.20) is to break the fuel into fine spray (atomised condition) as it enters the combustion chamber of diesel engine. In case of an MPFI engine petrol is injected at the end of compression stroke as the fine spray of the fuel burns more efficiently in the combustion chamber giving better fuel efficiency with less air pollution.

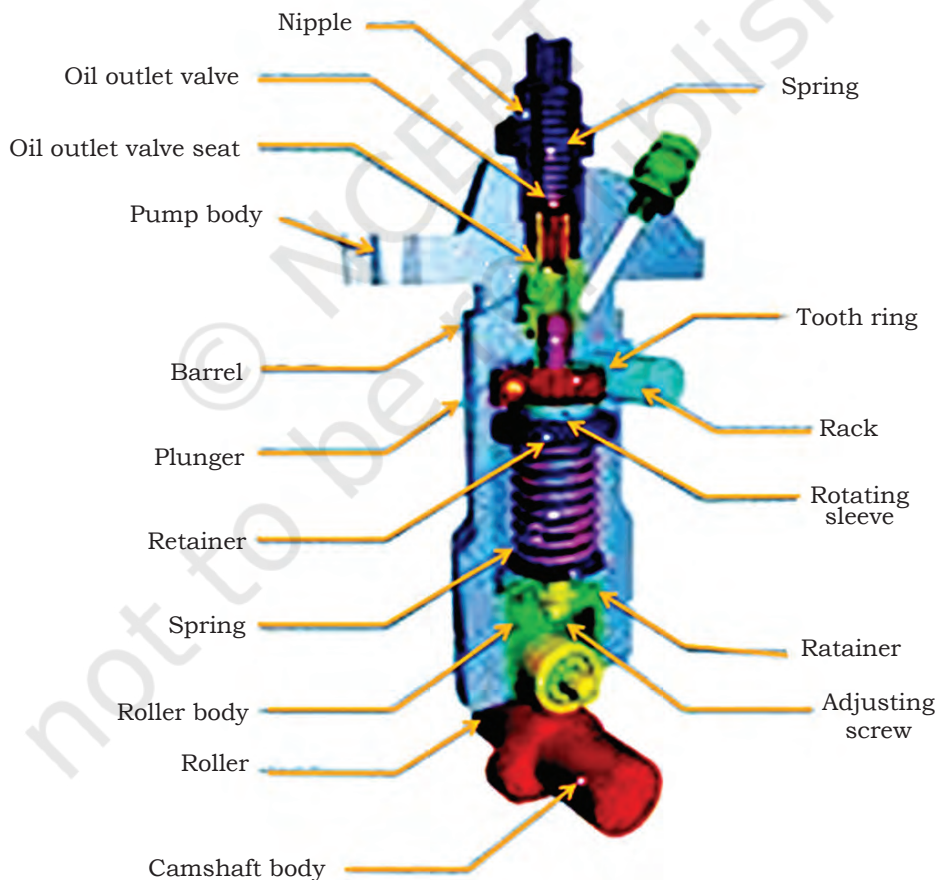

Fig. 3.20: Fuel Injector

Practical Exercises

Activity 1

Name any five components of an automobile system used in a vehicle.

S. No.	Name of the system
1.	
2.	
3.	
4.	
5.	
6.	
7.	

Check Your Progress

A. Fill in the blanks

1. Engine is the _____ of an automobile. Its role is very important.
2. Engine converts the Chemical Energy (heat energy) to _____ Energy.
3. Major parts of engine are _____, _____, _____ and _____.
4. The function of the carburettor is to supply uniform _____ to the cylinder of a _____ through the intake manifold.
5. Sparkplug is used to _____

B. Multiple choice questions

1. The compression-ignition engine air is compressed so that its temperature goes up to _____.
(a) 538 °C (1000 °F) or higher
(b) 348 °C
(c) 2480 °C
(d) None of the above

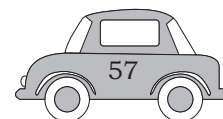

2. The cylinder of an IC engine is generally made of _____.
- (a) cast iron
 - (b) copper
 - (c) iron
 - (d) fibre
3. The charge (fuel and air mixture for SI engine and only air for CI engine) enters through the _____.
- (a) inlet valve
 - (b) spark plug
 - (c) outlet valve
 - (d) piston
4. The heart of the engine is the _____.
- (a) piston
 - (b) cylinder head
 - (c) connecting rod
 - (d) All of the above

C. Short answer questions

1. Explain the role of engine and its components.
2. Explain the difference between compression ignition engine and spark ignition engine?

SESSION 3: LUBRICATION SYSTEM

As you know, our body requires fluids like water and also oil in the form of fats like ghee, butter, cooking oil for maintenance of our system. Similarly, lubrication is required for maintenance of engine. Lubrication system is one of the most important parts of an engine. The engine cannot run smoothly for more than a few minutes without the lubricating oil.

Whenever two metallic surfaces move over each other under direct contact, dry or solid friction is produced. This is due to the irregularities on the two surfaces interlocking each other. The dry friction thus created produces a lot of heat and results in wear and tear of the metal surface.

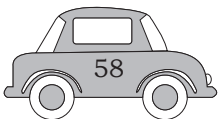

Objectives of Lubrication

The main objectives of lubrication are

- (i) to reduce friction between moving parts to its minimum value so that power loss is minimised, and
- (ii) to reduce wear and tear of the moving parts as much as possible.

Apart from these objectives, lubrication also serves other important purposes, which may be called secondary. These are as follows.

- (a) *To provide cooling effect:* The lubricating oil takes heat from the hot moving parts during its circulation and delivers it to the surrounding air through the crank case.
- (b) *To provide cushioning effect:* The lubricating oil also serves as a good cushion against the shocks experienced by the engine. For example, instant combustion of the fuel in the combustion chamber produces a sudden rise of pressure in the cylinder and the shock goes to the bearings through the piston, gudgeon pin and the connecting rod. This shock is then absorbed by the layer of oil present in the main bearings.
- (c) *To provide cleaning action:* The lubricating oil serves another useful purpose of providing a cleaning action. During its circulation, it carries away many impurities, such as carbon particles, etc.
- (d) *To provide a sealing action:* The lubricating oil also helps the piston rings in maintaining an effective seal against the high pressure gases in the cylinder thus preventing leakage towards the crank case.

Practical Exercises

Activity 1

List a few important functions of lubrication.

S. No.	Functions of lubrication
1.	
2.	
3.	
4.	

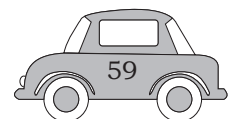

Check Your Progress

A. Fill in the blanks

1. Dry or solid friction is produced in _____.
2. Dry friction creates lot of _____.
3. The objective of lubrication is to reduce _____.
4. Lubrication provides _____ and _____ effect.

B. Multiple choice questions

1. Viscosity is measured using a _____.
(a) barometer
(b) thermometer
(c) viscometer
(d) fathometer
2. Lubricating oil is used for _____.
(a) minimising wear in moving parts
(b) help in keeping parts cool
(c) Both (a) and (b)
(d) None of the above
3. Which type of lubrication system is used in a two-stroke engine?
(a) petrol system
(b) wet sump system
(c) dry sump system
(d) All of the above
4. Viscosity index is a measure for the change of viscosity with change in _____.
(a) pressure
(b) temperature
(c) volume
(d) mass

C. Short answer questions

1. Explain the importance of lubrication in engine.
2. List the properties of lubricant.

SESSION 4: COOLING SYSTEM

Like our body requires air and water for cooling our system, similarly the engine of a vehicle also requires cooling.

The cooling system (Fig. 3.21(a-d)) has three primary functions, which are as follows.

- (i) Remove excess heat from the engine
- (ii) Maintain a constant engine operating temperature
- (iii) Increase the temperature of a cold engine as quickly as possible by maintaining the thermostat valve

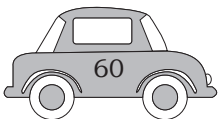

in a closed position which is fitted in the path of coolant circulation

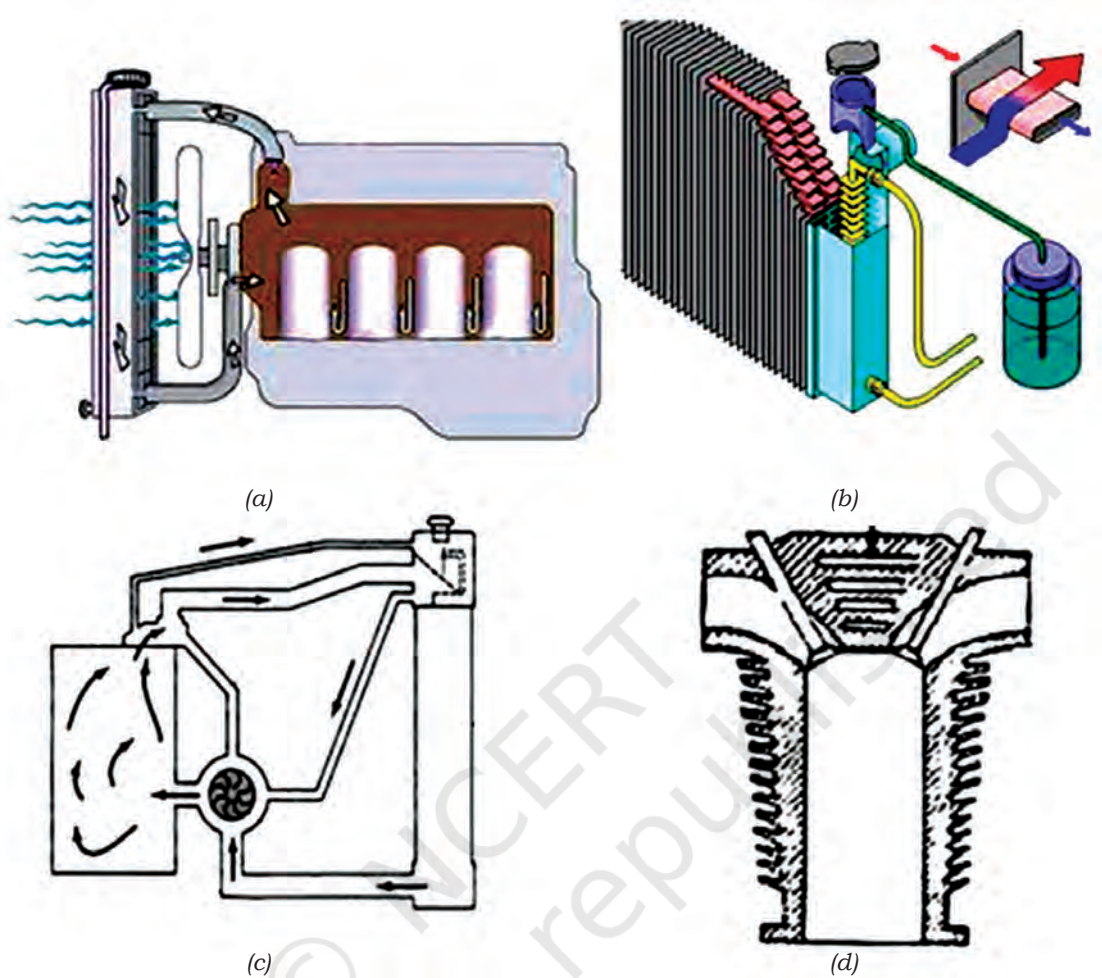

Fig. 3.21 (a-d): Cooling system of an engine

Necessity of Cooling

The cylinders of internal combustion engines require cooling because the engine cannot convert all the heat energy released by combustion into useful work. Liquid cooling is employed in most of the IC engines, whether they are used in automobiles or elsewhere. The water (coolant) is circulated around the cylinders to pick up heat and then dissipate it through a radiator. As the temperature increases from 71 to 82 degrees centigrade, the thermostat valve opens and sends water to the radiator to radiate the heat. When the temperature rises above 82 degrees, the thermostat switch operates the cooling fan to support the cooling process in radiator.

Practical Exercises

Activity 1

List a few important functions of the cooling system.

S. No.	Functions of cooling system
1.	
2.	
3.	
4.	
5.	

Check Your Progress

A. Fill in the blanks

1. The cooling system removes excess _____ from the engine.
2. Cooling _____ a constant engine operating temperature.
3. The objective of cooling is to reduce _____.
4. Liquid cooling is employed in most _____ engines.

B. Multiple choice question

1. Which of the following type of cooling system is used in a motorcycle?
 - (a) Air cooling system
 - (b) Water cooling system
 - (c) Both (a) and (b)
 - (d) None of the above
2. The cooling fan is _____.
 - (a) driven by belt and pulleys
 - (b) fitted between the engine and the radiator
 - (c) driven from the camshaft
 - (d) All of the above
3. In water cooling, the water in the jacket obtains heat from the cylinder due to _____.
 - (a) conduction
 - (b) convection
 - (c) radiation
 - (d) All of the above

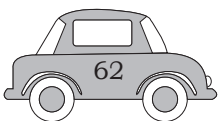

C. Short answer questions

1. How does a cooling system work?
2. What is the role of coolants?

SESSION 5: FUEL SUPPLY SYSTEM

Fuel Supply System

In petrol engines, the fuel and air mixture is supplied to the combustion chamber of an engine. This mixture is atomised and then vapourised by the carburettor. Then the mixture is ignited by the spark plug. The fuels, such as petrol, benzoyl and alcohol are used in an SI engine (Fig. 3.22). Nowadays, fuel is injected in the flow of air at a certain temperature and pressure and the fuel vapourises faster and the combustion process is better, with low emission. It also shows better fuel efficiency.

In case of compression ignition engine (diesel) the fuel is sent through the fuel pump to the injector and the injector sprays the fuel at end of compression stroke (Fig. 3.23). The oil fuels which are used in CI engines do not vapourise easily. Therefore, a separate injection system is used consisting of fuel injection pump (FIP) and injectors. These injectors atomise the fuel and it is then sent for combustion. Nowadays, in case of compression

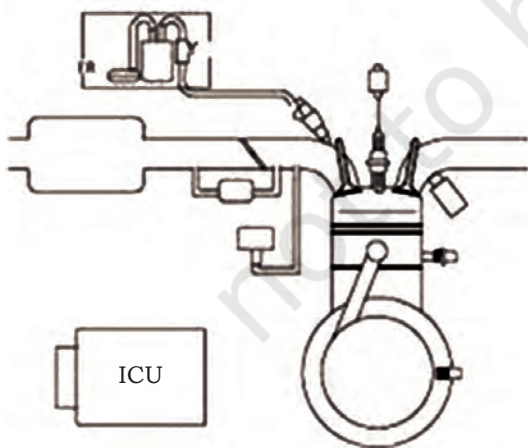

Fig. 3.22: Fuel Supply System

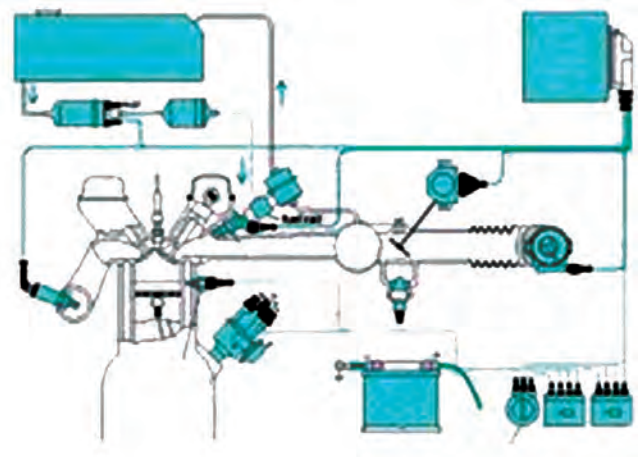
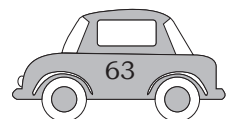

Fig 3.23: Fuel line



ignition engine the common rail direct injection system (CRDI) is used for better engine performance.

Fuel Supply Components

The fuel supply components include the following:

- 1. Fuel Tank:** In most of the vehicles the fuel tank is located at the rear end of the vehicle. The fuel tank is made of a metal sheet or plastic. It is attached to the chassis. The filler opening is closed with a cap. The fuel line is attached to the fuel pump and also to the fuel gauge.
- 2. Fuel Line:** The fuel line carries the fuel from the fuel tank to the carburettor or to the common rail system used in MPFI engines. The line has to withstand the pressure and provide resistance for the corrosion. The rigid line is placed safely in the chassis. It is connected to the units like carburettor, through a flexible pipe.
- 3. Fuel Filter:** The major role of the fuel filter is to send clean fuel to the engine. This prevents blockages in the fuel system. The filter contains a cartridge of filtering the element through which the fuel passes the filter traps any particles and prevents them from entering the fuel system. The fuel filter is required to be replaced at regular intervals.
- 4. Air Cleaner:** It is the main unit of the fuel system. It supplies clean air to the engine. The element of the air cleaner must be cleaned and replaced at regular intervals for maintaining a healthy life of the engine.
- 5. Fuel Injection Pump:** In case of a diesel engine, the diesel oil from the fuel tank is sucked by the fuel feed pump. The pump first sends the diesel oil to the fuel filter. From there it is sent to the transfer pump. The transfer pump increases the pressure of the fuel. This high pressure of the fuel is then transferred to the distributor rotor through the metering valve. From the rotor the fuel is sent to the injector. In case of multi-point fuel injection system the electric fuel pump is used. The pump generates

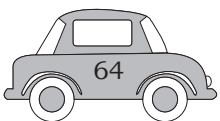

the injection pressure and sends it to the fuel filter and then to the common rail at a pressure of 3 to 4 bar. The common rail or fuel rail is connected to the fuel injector

- 6. Fuel Injector:** The solenoid injector used in the M.P.F.I fuel system is operated electrically as per the variation in the supply of current with resistance. The solenoid winding induces current within it and controls the movements of the needle valve to inject fuel as per the variations in speed and the load. The fuel system is controlled by the ECM.
- 7. Pressure Regulator:** It controls the amount of pressure that enters the injector. The extra fuel is sent back to the fuel tank.

Fuel Supply Components for SI Engine	Fuel Supply Components for CI Engine
<ul style="list-style-type: none"> • Fuel tank • Fuel lines • Fuel pump (A.C. mechanical type or electrical type) • Fuel filter • Carburettor • Inlet manifold • Air cleaner <p><i>Note:</i> In case of modern MPFI engines carburettor is replaced by injectors and sensors.</p>	<ul style="list-style-type: none"> • Fuel tank • Fuel lines • Fuel feed pump (Mechanical type or electrical type) • Fuel filters • Fuel injection pump (FIP) • Fuel injectors

Practical Exercises

Activity 1

List the important functions of the fuel supply system.

S.No.	Functions of the fuel supply system
1.	
2.	
3.	
4.	
5.	

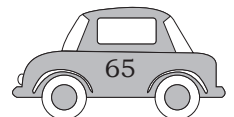

Check Your Progress

A. Fill in the blanks

1. Air and fuel are _____ outside the engine.
2. The fuels, such as petrol, benzol and alcohol are used in _____ engine.
3. Oil fuels which are used in CI engines do not _____ easily.
4. The fuel system is controlled by the _____.

B. Multiple choice questions

1. Which of these is used as a fuel in IC engine?
(a) methanol
(b) LPG
(c) Benzoyl
(d) All of the above
2. The carburettor is used to _____.
(a) mix petrol and air in correct proportion
(b) supply fuel air mixture to the engine
(c) Both (a) and (b)
(d) None of the above
3. In a multi-point fuel injection the injector is used for how many cylinder engines?
(a) Five
(b) Two
(c) Four
(d) Six
4. Which of the following is not an injector fault?
(a) Blue nozzle body
(b) Nozzle wetness blue nozzle body
(c) Excessive leak off
(d) Blow holes

C. Short answer questions

1. Write the importance of a fuel supply system.
2. Explain the correct method of injecting fuel in an automobile.

SESSION 6: TRANSMISSION SYSTEM

Transmission system is used in motor vehicles to supply the output of the internal combustion engine to the drive wheels. The transmission reduces the higher engine speed to the slower wheel speed, increasing

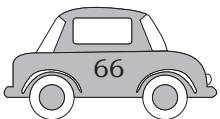

torque in the process. Transmissions are also used in pedal bicycles, fixed machines and where rotational speed and torque need to be adapted.

Transmission System

The transmission system consists of the following components.

- (i) Clutch assembly
- (ii) Gear box assembly (Transmission case assembly)
- (iii) Propeller shaft

Clutch assembly

Clutch (Fig. 3.24) is a mechanism which enables the rotary motion of one shaft to be transmitted, when desired. The axes of driving shaft and driven shaft are coincident.

Functions of clutch

- (a) To disconnect the engine power from the gear box as required, under the following circumstances:
 - (i) to start the engine and warm it up;
 - (ii) to engage first and second gear to start the vehicle from rest;
 - (iii) to facilitate changing the gear as required; and
 - (iv) disconnect from the engine to stop the vehicle after application of brakes.
- (b) To allow the engine to take up load gradually without shock or jerk.

Requirements of a Clutch

The clutch should meet the following requirements.

- (a) Torque transmission or the ability to transmit maximum torque of the engine.

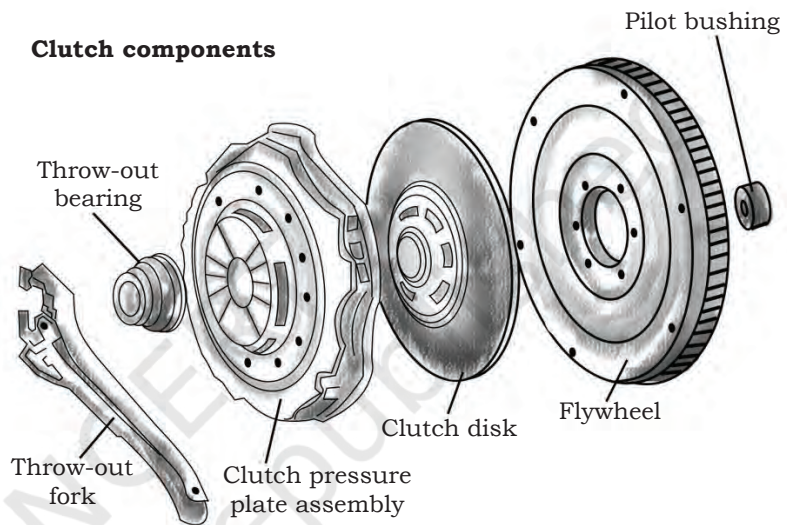
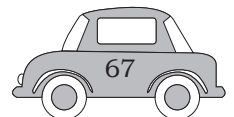

Fig. 3.24: Clutch assembly



- (b) Gradual engagement, i.e., to engage gradually and avoid sudden jerks.
- (c) Heat dissipation, i.e., ability to dissipate large amount of heat generated during the clutch operation due to friction.
- (d) Dynamic balancing, which means that the clutch should be dynamically balanced. This is particularly required in the case of high-speed engine clutches.
- (e) Vibration damping, i.e., having a suitable mechanism to damp vibrations to eliminate noise produced during the power transmission.
- (f) Size of the clutch should be as small as possible so that it occupies minimum space.
- (g) Free pedal play, which helps the clutch to reduce effective load on the carbon thrust bearing and its wear.
- (h) Easy in operation and requiring as little exertion as possible on the part of the driver.
- (i) Light weight of the driven member of the clutch so that it does not continue to rotate for any length of time after the clutch has been disengaged.

Main Parts of a Clutch

The main parts of a clutch are divided into three groups.

- (a) *Driving members*: The driving members consist of a flywheel mounted on the engine crankshaft. The flywheel is bolted to a cover which carries a pressure plate or driving disc, pressure springs and releasing levers. Thus, the entire assembly of the flywheel and the cover rotate all the time. The clutch housing and the cover provided with openings, dissipate the heat generated by friction during the clutch operation.
- (b) *Driven members*: The driven members consist of a disc or plate, called the clutch plate. It is free to slide lengthwise on the splines of the clutch shaft (primary shaft). It carries friction material on both of its surfaces. When it is gripped between the flywheel and the pressure plate, it rotates the clutch shaft through the splines.

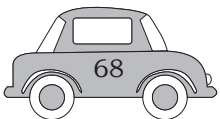

- (c) *Operating members*: The operating members consist of a foot pedal, linkage, release bearing, release levers and the springs.

Gear Box (Transmission Case) Assembly

We need different gear ratios in the gear box or transmission system to enable the vehicle to move at different speeds. At the time of starting the vehicle, the maximum amount of torque is available on the flywheel, for which low gear ratio is selected for the movement of the vehicle. As the engine speed increases, the amount of torque is reduced on the flywheel and it is required to select higher gear ratio.

Functions of a gear box

- (i) To provide a means to vary the leverage or torque ratio between the engine and the road wheels as required.
- (ii) The transmission also provides a neutral position so that the engine and the road wheels are disconnected even with the clutch in the engaged position.
- (iii) It provides a means to reverse the car by selecting the reverse gear.

Practical Exercises

Activity 1

Make a list of the parts of clutch assembly used in a vehicle.

S.No.	Parts of clutch assembly
1.	
2.	
3.	
4.	
5.	

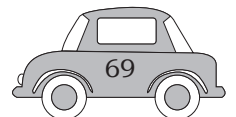

Check Your Progress

A. Fill in the blanks

1. Transmission system consists of _____ components.
2. The main parts of a clutch are _____ and _____.
3. Different gear ratios in the _____ makes the vehicle move at different speeds.
4. The clutch assembly consist of flywheel, pressure plate and _____.

B. Multiple choice questions

1. Which of these systems is used in motor vehicles to supply the output of the internal combustion engine to drive wheels?
(a) Transmission system
(b) Power system
(c) Torque system
(d) None of the above
2. Which type of transmission system is used for a disengagement and engagement between the engine and the remainder of transmission system?
(a) Clutch
(b) Differential
(c) Propeller shaft
(d) None of the above
3. In a four-wheel drive there is _____.
(a) one live axle
(b) no live axle
(c) two live axle
(d) None of the above
4. _____ produces different gear ratios in automobiles.
(a) Transmission system
(b) Differential
(c) Steering
(d) Gear box

C. Short answer questions

1. Discuss the role of a transmission system.
2. Explain the function of a gear box.

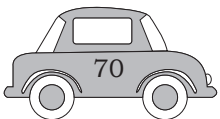

SESSION 7: FRONT AND REAR AXLE

In this session, we shall discuss the axle and steering system, which transmits power to the wheel. It plays a crucial role in the movement of a vehicle.

Propeller Shaft

This is a shaft which transmits power from an engine to the wheels of a motor vehicle. It is a hollow tubular shaft and consists of mainly three parts.

- (i) *Shaft*: It mainly bears torsional stress produced due to twisting. It is usually made of tubular cross section.
- (ii) *Universal joints*: One or two universal joints are used, depending on the type of rear axle drive used. The universal joints help in the up and down movements of the rear axle when the vehicle is in running condition.
- (iii) *Slip joint*: Depending on the type of drive, one slip joint may be there in the shaft. This serves to adjust the length of the propeller shaft when demanded by the rear axle movements.

Front and Rear Axle

Front axle

Front axle carries the weight of the front portion of the automobile as well as facilitates steering and controls the rolling of wheels. It also absorbs road shocks arising due to road surface variations.

In case of a commercial vehicle the front axles (Fig. 3.25) are generally dead axles. The front axle is designed to transmit the weight of the automobile from the springs

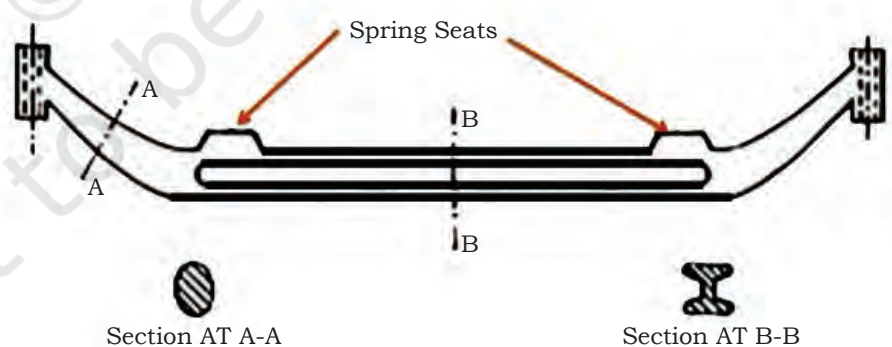

Fig. 3.25: Front axle

to the front wheels, turning right or left as required. To prevent interference due to front engine location, and for providing greater stability and safety at high speeds by lowering the centre of gravity of the road vehicles, front axle includes the axle-beam, stub-axles with brake assemblies. It is made of drop forged alloy steel consisting of 0.4% carbon steel and 1.3% nickel steel.

The axle is made of I-section at centre and of circular or elliptical section in the ends since it has to bear the bending stress and torsional stress. In order to lower the chassis height a downward sweep is provided at the centre of the beam axle.

The main beam axle is connected to the stub axle with a king pin. The front road wheels are mounted on the stub axle.

For smooth steering effects and maintaining proper control, the front axle of a car is supported with an independent suspension system, such as Mac-pherson. The strut and coil spring allows the wheel to move up and down but does not allow to change the driving angle of axle shaft to transmit the drive smoothly. It also allows the wheel to rotate freely. This supports in steering the vehicle.



Fig. 3.26: Rear axle

Rear Axle

Like the front axle, the rear axle is also made of drop forged steel. The rear axle (Fig.3.26) bears the weight of the vehicle body and load with springs. It enables to transmit the driving and breaking torque to the chassis frame and body of the vehicle. It also bears the side thrust or pull due to any side load on the

wheel. It supports various parts like bevel pinion, bevel gear, cage of sun gear and star pinions, axle shafts, and different support bearings.

It is important to note that rear road wheels are mounted on the axle shaft and the differential mechanism enables the outer wheel to move faster than the inner wheel while taking a turn.

Practical Exercises

Activity 1

Make a list of parts of rear axle of a vehicle.

S. No.	List of parts of rear axle
1.	
2.	
3.	
4.	
5.	

Check Your Progress

A. Fill in the blanks

- Axle and steering system transmit _____ to the wheel.
- Front and rear axle system is used for _____.
- Differential mechanism enables the _____ to move faster than the inner wheel while taking a turn
- Rear axle _____ the weight of vehicle body.

B. Multiple choice questions

- The central portion of the front axle is made of _____.

(a) I section	(b) T section
(c) Q section	(d) U section

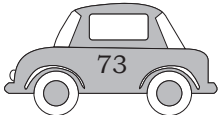

2. The end of the front axle is mounted with _____.
- | | |
|-----------------|----------------|
| (a) stub axles | (b) king pin |
| (c) piston ring | (d) axle shaft |
3. What kind of load does the axle take due to the load of the vehicle?
- | | |
|--------------------|---------------------|
| (a) Bending load | (b) Frictional load |
| (c) Torsional load | (d) None of these |

C. Short answer questions

1. What is the role of a front axle?
2. Why are rear axles required?

SESSION 8: STEERING AND SUSPENSION SYSTEM

Steering System

The steering mechanism permits the driver to control the car on a straight road and turn right or left as desired. The steering mechanism includes a steering wheel, which the driver controls, a steering gear, which converts rotary motion of steering wheel in to straight line motion and steering linkages. In modern cars, the manually operated steering system (Fig. 3.27) is assisted by power and is called power steering. The electric power drawn from the battery or hydraulic power is used.



Fig. 3.27: Steering System

Functions of a Steering System

1. It provides directional stability to the vehicle when moving in a straight (ahead) direction.

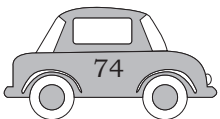

2. It provides perfect steering condition, i.e., perfect rolling motion of the wheels at all times.
3. It facilitates straight ahead recovery after completion of turn.
4. It controls the wear and tear of the tyre.
5. It is used to turn the vehicle as per the will of the driver.
6. It converts the rotary motion of the steering wheel into angular displacement of the front wheel.
7. It multiplies the effort of the driver to ease operation.
8. It absorbs road shocks and prevents them from reaching the driver.

Requirements of a Good Steering System

1. It should be very accurate.
2. It should be easy to handle.
3. The effort required should be minimal.
4. It should provide directional stability.
5. The front wheels should roll without lateral skid while negotiating curves.
6. There should be proper proportion between the angles turned by the front wheels.
7. The tyre must have good elasticity so that on turns, these may follow an arc of greater radius than the stiff tyre.
8. The wheels should automatically come to the straight ahead position after negotiating the bend. When going straight, the wheels must maintain the neutral position.
9. The angular oscillations of the wheels must be minimum.
10. The system must be irreversible to a certain degree so that minimum front wheel shocks are transmitted to the driver's hands.

Steering Mechanism

For perfect steering, it must always have an instantaneous centre about which all the wheels must rotate. To achieve this the inner wheel has to turn more than the outer wheel. Two types of

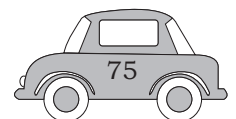

mechanism are available, viz., the Davis and the Ackermann steering mechanism. Out of these Ackermann type is more popularly used because of its simplicity. It also lessens wear of tyre and lowers friction.

Steering Linkages

A steering linkage is the part of an automotive steering system that connects to the front wheels. In a commercial vehicle a rigid axle type front suspension system is used.

Steering Wheel

It is made of polyurethane or hard plastic. It consists of a circular rim with a hub at the centre. The rim is slightly elliptical in cross section to maintain strength and provide hand grip. The steering shaft is mated in the undulations cut on the inside of the steering wheel hub.

Steering Column

It is tubular in nature. It provides switches for horn, light and wiper for easy and quick operation. The collapsible columns are used for safety, which collapse upon impact and reduce the chances of injury to the driver.

Steering Shaft

It is made from drop forged alloy steel. It connects the steering wheel to the steering gear box and transfers movements of the steering wheel to the steering gear, or to the pinion.

Drop Arm

It is also called as pitmen arm. It is made up of drop forged steel. It connects the cross shaft with the draglink.

Draglink

It connects the drop arm to the steering knuckle. It is also made up of drop forged steel.

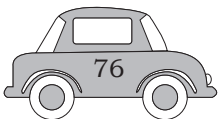

The tie rod ends are different parts of the steering linkage will be connected to the ball joints which provide angular motion to the steering system.

Steering Gears

The steering gear converts the turning motion of the steering wheel into the to-and-fro motion of the link rod of the steering linkage. It also provides the necessary leverage so that the driver is able to steer the vehicle without fatigue.

Suspension System

Suspension is the term given to the system of springs, shock absorbers and linkages that connects a vehicle to its wheels. The suspension system serves a dual purpose, contributing to the vehicle's road holding or handling and braking for safety and driving comfort, and keeping the vehicle occupants comfortable and reasonably well isolated from road noise, bumps and vibrations, etc.

Functions of suspension system

The main functions of a suspension system are as follows:

- (i) To safeguard the occupants against road shocks and provide riding comfort.
- (ii) To minimise the effects of stresses due to road shocks on the mechanism of the motor vehicle and provide a cushioning effect.
- (iii) To keep the body perfectly in level while travelling over rough uneven ground, i.e., the up and down movement of the wheels should be relative to the body.
- (iv) To isolate the structure of the vehicle from shock loading and vibration due to irregularities of the road surface without impairing its stability.
- (v) To provide the requisite height to the body structure as well as to bear the torque and braking reactions.

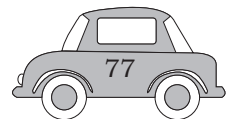

Various Components of Suspension System

The components of a suspension system can be categorised as follows.

Mechanical Suspension

- (i) Leaf springs
- (ii) Coil springs
- (iii) Rubber springs
- (iv) Torsion bars

Hydraulic Suspension

- (i) Hydraulic shock absorber
- (ii) Telescopic fork absorber

Air Suspension

Compressed air is used in an air suspension system.

Mechanical Suspension

1. **Leaf Spring:** A leaf spring (Fig. 3.28) is a component of a vehicle's suspension system. Leaf springs are curved and the curvature helps the spring absorb impact.



Fig 3.28: Leaf spring

2. **Coil Spring:** Coil springs are commonly called compression springs, torsion springs or helical springs. They store energy and release it to absorb shock or maintain a force between two contacting surfaces. Mostly coil springs or helical springs are used in engine starter and hinges (Fig. 3.29).
3. **Rubber Spring:** A rubber spring stores more energy per unit mass than any other type of spring

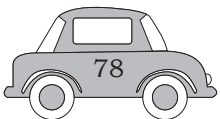

material. The rubber spring (Fig. 3.30) is installed between the frame and the top link of the suspension system. When the spring is connected to a point near the link pivot, deflection of the spring reduces to a minimum, without affecting the total wheel movement. The energy released from the rubber spring after deflection is considerably less than that imparted to it.

4. **Torsion Bars:** Torsion bars are of two types—helical or spiral. These bars are used in automobile vehicles for transmitting torque.

Hydraulic Suspension

Hydraulic suspension combines rubber springs with a damper system, linking the front and rear wheel on the same side of the car. As the front wheel rises over a bump, some of the fluid from its suspension unit (known as a displacer unit) flows to the rear-wheel unit and raises it, so tending to keep the car level. In each of the displacer units, the fluid passes through a two-way valve, which provides the damping effect. Once the rear wheel has passed over the bump, the fluid returns to the front displacer unit and the original level is restored.

1. **Hydraulic Shock Absorber:** It is a mechanical device designed to absorb shock impulses. This device is also used for checking or damping out the suspension spring to a comfort level.
2. **Telescopic Fork Absorber:** A telescopic fork is a form of motorcycle front suspension whose use is so common that it is virtually universal.



Fig. 3.29: Coil spring



Fig. 3.30: Rubber spring added

The telescopic fork uses fork tubes and sliders which contain springs and dampers.

Air Suspension

In this suspension, compressed air is used as a spring. This suspension system is operated with air and controlled by a microprocessor. It helps in maintaining self-driving conditions and supports the weight of the vehicle.

Practical Exercises

Activity 1

List the components of a suspension system.

S. No.	Name of the component
1.	
2.	
3.	
4.	
5.	
6.	
7.	
8.	
9.	
10.	

Check Your Progress

A. Fill in the blanks

1. Steering system is used for _____.
2. Main parts of steering system are _____ and steering column.
3. A suspension system consists of springs, _____ and linkages that connect a vehicle to its wheels.
4. A suspension system keeps vehicle occupants _____.

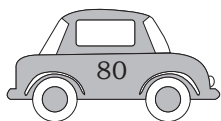

B. Multiple choice questions

1. The tilting of the front wheels away from the vertical is called _____.
 - (a) camber
 - (b) caster
 - (c) toe-in
 - (d) toe- out
2. Which of the following types of mechanism is used in a steering system?
 - (a) Rack and pinion steering
 - (b) Rotary motion is turning
 - (c) Reciprocating motion
 - (d) Power steering system
3. Leaf spring absorbs shocks by _____.
 - (a) tension
 - (b) compression
 - (c) twisting
 - (d) bending
4. Compressed air is used for _____.
 - (a) air suspension system
 - (b) hydraulic suspension
 - (c) mechanical suspension
 - (d) None of the above

C. Short answer questions

1. How does a steering system work?
2. What is a power steering system?

SESSION 9: WHEEL, TYRE AND BRAKE

Wheel

The wheel is an important component of a vehicle. Wheel of a four-wheeler vehicle is mounted on a hub and consists of parts like rim, tyre and tube (Fig.3.31). The wheels not only support the weight of the vehicle, but also protect it from road shocks. All the four wheels must resist the braking stresses and withstand side thrust. A wheel should be light and easily removable.

Functions of the wheel

- (i) To withstand the weight of the vehicle.
- (ii) To absorb road shocks.
- (iii) To grip the road surface.



Fig. 3.31: Wheel

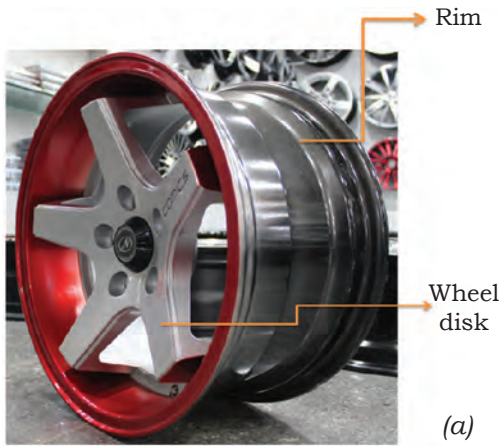

(a)



(b)

Fig. 3.32(a-b): Rim

- (iv) To balance dynamically (i.e., when the vehicle is in motion) and statically (i.e., when the vehicle is at rest).

Rim

The rim (Fig. 3.32 [a-b]) is the 'outer edge of a wheel, holding the tyre'. It makes up the outer circular design of the wheel on which the inside edge of the tyre is mounted on vehicles, such as automobiles. For example, on a bicycle wheel the rim is a large hoop attached to the outer ends of the spokes of the wheel that holds the tyre and the tube.

Different types of wheel rim

- (i) Disc wheel rim
- (ii) Wire spoke wheel rim (used in motorcycle, bicycle)
- (iii) Split wheel rim (used in scooter)
- (iv) Heavy vehicle wheel rim (available in three piece and four piece including locking ring)

1. Disc wheel Rim: A wheel is generally composed of rim and disc. Rim is an outer part of the wheel and holds the tyre. Disc is a part of wheel which connects the rim and the axle hub.

2. Wire Spoke Wheel Rim (used in motorcycle, bicycle): Wire spoke wheel rim is where the outside part of the wheel (rim) and axle installed part are connected by many numbers of wires called spokes.

3. Spilt Wheel Rim (used in scooter): Spilt wheel rim is used in a multi-piece wheel. This wheel rim holds the tyre with a locking ring. A split wheel rim cannot be used normally in all types of vehicle.

4. Heavy Vehicle Wheel Rim (available in three piece and four piece including locking ring): Heavy vehicle wheel rim have a three and four-piece locking ring. This type of wheel rim is used in heavy vehicles wheel like truck, buses container, etc., because it has a longer life.

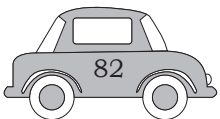

Tyre

The tyre (Fig. 3.33) is mounted on the wheel rim. It carries the vehicle load and provides a cushioning effect. It must produce minimum noise, while the wheel turns on the road. It resists the tendency for the vehicle to oversteer. It should have good grip while accelerating and braking the vehicle on both dry and wet roads.

Desirable Properties of a Tyre

A tyre must have the following properties.

- (i) *Non-skidding*: The tyre must have grip to avoid skidding or slipping on the road surface.
- (ii) *Uniform wear*: The tyre must get worn uniformly over its outer circumference.
- (iii) *Load carrying*: The tyre is required to carry the vehicle load.
- (iv) *Cushioning*: The tyre needs to absorb the vibrations due to the different road surfaces and their impact, and thus, provide cushioning effect to the vehicle.
- (v) *Power consumption*: While rolling on the road, the tyre should consume little power created by the engine.
- (vi) *Noise*: The tyre should create minimum noise while running on the road.
- (vii) *Balancing*: The tyre should be balanced dynamically as well as statically, i.e., maintain balance at both times—when the vehicle is in motion as well as at rest.

Functions of Tyre

- (i) To carry the load of the vehicle.
- (ii) To absorb minor road shocks.
- (iii) To reduce vibration to some extent.
- (iv) To transmit the power from the engine through gear box, propeller shaft and rear axle to the ground with which the vehicle moves.
- (v) The treads made on the tyres grip the road for better traction.



Fig. 3.33: Tyre

Types of Tyre

- (i) *Solid tyre*: It is used in children's cycle and is filled with solid material, like rubber, which makes it sturdy.
- (ii) *Tube tyre*: It consists of a tube between the rim and the tyre, in which air is filled. It is used in most of the vehicles seen on road.
- (iii) *Tubeless tyre*: Nowadays, with the advancements in technology, tubeless tyres are replacing the tube tyres. Tubeless tyres are mainly used in modern cars. The benefits of tubeless tyres include slow leakage of air during punctures, better balancing of wheels, low cost and ease of puncture repairing.

Brake

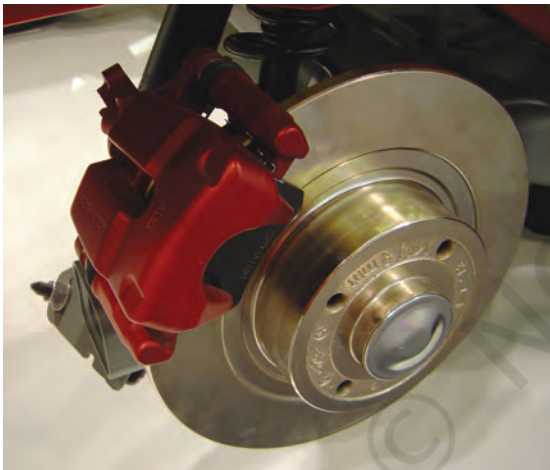
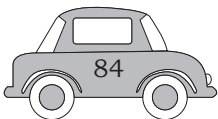

Fig. 3.34: Brake

Brakes (Fig. 3.34) are one of the most important control components of a vehicle. They are required to stop the vehicle within the smallest possible distance and this is done by converting the kinetic energy of the wheels into the heat energy which is dissipated into the atmosphere.

Requirements of A Good Braking System

- (i) To stop the vehicle in the shortest possible distance and time.
- (ii) To control the vehicle speed while moving on plain roads and hills.
- (iii) To work equally well on fair and bad roads.
- (iv) To ensure that the pedal effort applied by the driver is not much, thereby reducing the inconvenience for the driver.
- (v) To work efficiently in all weathers.
- (vi) It should have very few wearing parts.
- (vii) It should require little maintenance.
- (viii) Brake, when applied should not disturb the steering geometry.
- (ix) There should be minimum sound when brake is applied.



Types of Brake

1. **Foot Brake:** Foot brake is one of the most common brake systems operated by the foot pedal. When pressure is applied to the foot pedal, the vehicle stops. Pedal force applied by the driver is further multiplied and sent to the braking drum or disc either by mechanical linkages or by hydraulic pressure which in turn causes braking. It is also known as a service brake.

2. **Hand Brake:** Hand brakes are usually used for stable parking of the vehicle either on a flat road or slope. They are also called parking brakes. Hand brakes are connected to the brake mechanism directly and the other end is operated by the driver. This type of brake is also known as an emergency brake as it is independent of the main service brake.

3. **Drum Brakes or Internal Expanding Brakes:** Drum brakes (Fig. 3.35) are usually used as rear brakes in most automobiles, which utilise the friction between the drum and the brake shoes to stop the vehicle. This type of brake is fitted in automobile light vehicles, such as cars and light trucks. These brakes have two shoes, the left-hand shoe is known as a primary shoe and the right-hand shoe is known as a trailing shoe. Shoes are fitted in the drum. The friction between the shoes and the drum produces the braking torque and reduces the speed of the drum so that the vehicle stops.

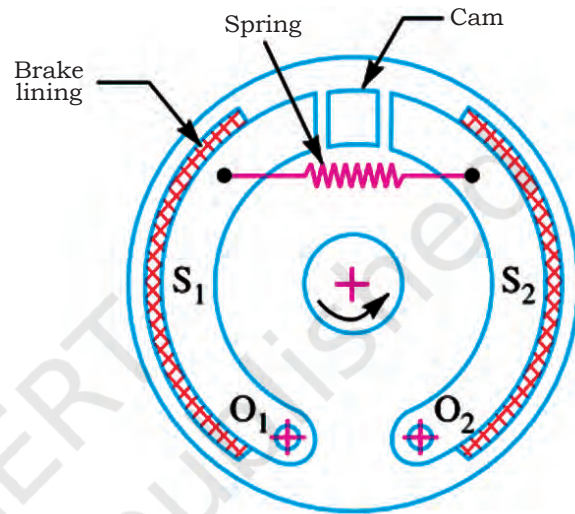
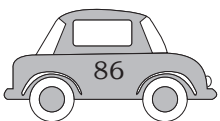

Fig. 3.35: Drum brake

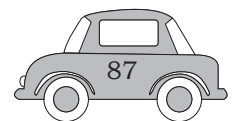

Fig. 3.36: Disc Brake

4. **Disc Brake or External Contracting Brakes:** It is the type of braking system in which instead of a drum assembly a disc rotor is attached to the hub of the wheel in such a fashion that it rotates with the wheel (see Fig. 3.36). This disc rotor is clamped in between the caliper which is rigidly fixed with the knuckle or upright of the vehicle. When brakes are applied the actuation mechanism contracts the attached brake shoes which in turn make the frictional contact with the rotating disc rotor and cause the stopping of a vehicle. An external contracting brake is used for only parking purpose as well as used to operate in flour mills, various types of electrical components, etc.
5. **Mechanical Brake:** This brake system has an inbuilt mechanical device for absorbing energy from a moving system. Mechanical brake is a cable pull system, which consists of rim-like brakes just arranged in a different way.
6. **Power Brake:** Power brake system is a combination of the mechanical components to multiply the force applied to the brake pedal by the driver to stop the vehicle. In a power brake system we mainly use the vacuum booster and master cylinder, brake calipers, drum brake, etc. These braking systems are designed to reduce the effort required to depress the brake pedal when stopping a vehicle.
7. **Vacuum Brake:** It is the conventional type of braking system in which vacuum inside the brake lines causes brake pads to move, which in turn finally stop or deaccelerate the vehicle. This type of brake is mainly used in railways in place of air brakes. This brake can remove the kinetic energy and convert it into a form of heat. The conversion is usually done by applying a contact material to the rotating wheel attached to the axles. Vacuum brakes are cheaper than air brakes but are less safe than air brakes.



8. **Air Brake:** Air brake system is a very advanced braking system. It is generally used in very heavy vehicles like buses and trucks. It is the type of braking system in which the atmospheric air through compressors and valves is used to transmit brake pedal force from brake pedal to the final drum or disc rotor. Air brakes generate higher brake force than hydraulic brake which is the need of the heavy vehicle. High-end cars these days are using air brake systems due to its effectiveness and fail proof ability.
9. **Hydraulic Brakes:** A hydraulic braking system transmits brake-pedal force to the wheel brakes through pressurised fluid, converting the fluid pressure into useful work of braking at the wheels. The brake pedal relays the driver's foot effort to the master-cylinder piston, which compresses the brake fluid. This fluid pressure is equally transmitted throughout the fluid to the front disc-caliper pistons and to the rear wheel-cylinder pistons. The pressure on a liquid is called hydraulic pressure. The brakes which are operated by means of hydraulic pressure are called hydraulic brakes.
10. **Anti-lock Braking System:** Anti-lock Braking System prevents the wheels from locking or skidding. The anti-lock braking (ABS) system is a component that ensures passenger safety by stopping the vehicle in adverse conditions, like stopping very quickly or if the road is slippery. To simplify it, the ABS prevents the wheels of the vehicle from locking up and causing you to skid out of control.
11. **Electric Brake:** It is the type of braking used in electric vehicle. Electric brakes use electrical motors which are the main source of power in electric vehicles. Electric brakes or secondary shoe are similar to the drum brakes in an automobile. Electric brakes are actuated by an electromagnet.



Practical Exercises

Activity 1

List the different types of brake used in an automobile.

S. No.	Types of brake
1.	
2.	
3.	
4.	
5.	
6.	
7.	
8.	

Check Your Progress

A. Fill in the blanks

1. Wheel is an important component of the _____.
2. Tyre is fitted on the _____.
3. Brake should work _____ on roads.
4. Hand brake is also known as _____ brake.

B. Multiple choice questions

1. The most important component of a vehicle is _____.
(a) wheel
(b) rim
(c) disk
(d) tyre
2. The tyre is mounted on the _____.
(a) vehicle
(b) disc

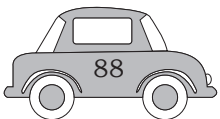

- (c) wheel rim
 - (d) None of the above
3. The main component of the generating or charging system is (are) _____.
- (a) generator/alternator
 - (b) ammeter
 - (c) the battery
 - (d) All of the above

C. Short answer questions

1. What are the components of a wheel?
2. How does the brake system function?

SESSION 10: ELECTRICAL OR ELECTRONIC AND AIR CONDITIONING SYSTEMS

Electrical or Electronic System

Nowadays, all the automobiles run with the help of electrical and electronic system, and therefore, it plays an important part in the functioning of an automobile.

The electrical and electronic systems consist of the following.

- (i) *Starting system*: The starting motor is driven by means of the current taken from the battery.
- (ii) *Ignition system*: The function of the ignition system is to produce a spark in the engine combustion chamber at the end of the compression stroke.
- (iii) *Generating or charging system*: The function of the charging system in an automobile is to generate, regulate and supply the electrical energy for charging the battery.
- (iv) *Lighting system*: It consists of various types of lighting used during the vehicle running, such as head light, tail light, fog light, brake light, reversing light, left and right indicators, parking light, cabin light, panel board lights, etc.
- (v) *Connections for other accessories*.

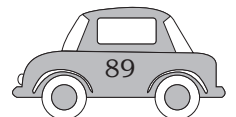

Main components of the electrical system

Starting system	Generating or Charging system	Ignition system	Lighting system	Accessories
<ul style="list-style-type: none"> • Battery • Starting • Motor • Motor • Control 	<ul style="list-style-type: none"> • Generator/ Alternator • Ammeter • The cut-out • Switch • Battery • Voltage and current regulator 	<ul style="list-style-type: none"> • Battery • Ignition switch • Ignition coil • Distributor • Spark plugs • Contact breaker • Automatic advance and retard unit • Vacuum control unit 	<ul style="list-style-type: none"> • Headlight • Side light • Rear light • Fog Lamps • Number plate illumination lamp • Interior lights • Indicator flashers 	<ul style="list-style-type: none"> • Horns • Wind screen wiper • Electric fuel pump • Fuel gauges • Temperature gauge • Radio sets • Cigar lighter/mobile phone charger • Heater • Wind screen defroster • Signalling devices

Note: In modern vehicles, various types of electronic sensors and actuators are fitted in different systems of the engines, which are also operated electrically.

Air Conditioning System

During summer, an automobile requires considerable amount of refrigerating capacity to maintain cool and comfortable conditions in the sitting space. Similarly, when moving in a cold day in winter, the same vehicle would require considerable heating capacity to keep it comfortably warm for passengers.

Modern-day automobiles have an air conditioning unit (Fig. 3.37) to maintain suitably controlled temperature and humidity conditions inside the vehicle. In automobiles, an air conditioner is a refrigeration



Fig. 3.37: Air conditioner in a car

machine which requires electrical energy drawn from the battery system. The battery is charged by energy of the engine.

For heating purposes, the warm water from the engine cooling system is used. The heat required to warm the automobile is generally provided by circulating warm water through a heating coil.

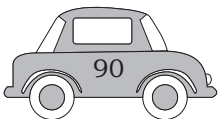

Besides controlling the temperature levels, the air conditioner also cleans the air. During summer, the humidity of the air inside the vehicle is reduced with air conditioner in operation, which makes the sitting area comfortable. Car air conditioner comes inbuilt in air conditioned (AC) car models. However, these can also be fitted at a later stage in a non-AC model of the car.

Different Components of Automobile Air Conditioning System

- (i) Compressor
- (ii) Magnetic clutch
- (iii) Condenser
- (iv) Receiver-drier (or dehydrator)
- (v) Expansion valve
- (vi) Evaporator
- (vii) Throttling valve

- 1. Compressor:** A compressor is unit driven by the engine. It has a low pressure side port which is connected to the evaporator and a high pressure side port which is connected to the condenser using rubber hoses. The compressor is the main mechanical part of the system. In hybrid engines the compressor is electrically powered. A small electric motor is fitted inside the compressor which pressurises the refrigerant. These compressors have a pair of large gauge wires which form the compressor controller. In latest cars, where the climatrons are used the electric power supply is controlled by ECU as per the temperature settings.
- 2. Clutch:** The compressor is always fixed with a clutch. The major function of the clutch is to transmit the power smoothly to the compressor when the system is operated.
- 3. Condenser:** The major function of this device will be to change the high-pressure refrigerant vapour to a liquid. The condenser is mounted in front of the engine's radiator, and it looks similar to

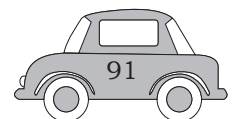

a radiator. The condenser is a cooling device in which the vapour is condensed to a liquid because of the high pressure that is driving it in, and this generates a great deal of heat. The heat is then in turn removed from the condenser by air flowing through the condenser on the outside.

4. **Receiver-drier:** The main function of this device is to filter refrigerant. The liquid refrigerant moves to the receiver-drier. This is a small reservoir vessel for the liquid refrigerant, which removes any moisture that may have leaked into the refrigerant and also stores excess quantity of refrigerant.
5. **Expansion Valve:** The pressurised refrigerant flows from the receiver-drier to the expansion valve. The expansion valve is a controlling device which controls the varying load when there are pressure changes in the evaporator, as it may increase or decrease. The valve maintains a constant pressure throughout the varying load on the evaporator controlling the quantity of refrigerant flowing into the evaporator.
6. **Evaporator:** It is the main component of a refrigeration system and is also called the cooling coil. It has tubes and fins or freezing coil. It is usually placed inside the passenger compartment above the footwell. As the cold low-pressure refrigerant is passed into the evaporator, it vapourises and absorbs heat from the air in the passenger compartment. The blower fan inside the passenger compartment pushes air over the outside of the evaporator, so cold air is circulated inside the car. On the 'air-side' of the evaporator, the moisture in the air is reduced, and the 'condensate' is collected.
7. **Throttling Device:** It is a part of refrigeration system and air conditioning system. When refrigerant comes out from the condenser at a medium temperature and high pressure, it enters the throttling valve. In the throttling valve, the pressure and temperature of the refrigerant are decreased suddenly and the cooling effect is provided to the evaporator.

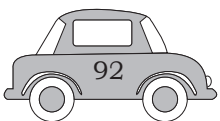

Working of Air Conditioning System

In a car's air conditioning system, the refrigerant vapour from the evaporator is compressed to high pressure by the compressor. The compressor is driven by the engine through a belt drive. In a hybrid car, the compressor is driven by the motor and the power is used from the battery.

The compressor is connected by an electromagnetic clutch which serves, engages and disengages the compressor as required. A variable displacement A/C compressor is sometimes used to match a compressor capacity to varying cooling requirement. The refrigerant pressure and temperature increases in the compressor and converts it into the vapour form and then to the condensed form. In the condenser the refrigerant liberates heat and converts into the liquid form.

Sometimes the air is not sufficient and therefore, an extra engine or electric driven fan is used to cool the refrigerant. This cooled but high pressure refrigerant is passed through the dehydrator to extract any moisture. Dry refrigerant liquid is then made to pass through expansion valve mounted at the inlet side of the evaporator. The expansion valve allows the refrigerant liquid to expand to low pressure in the evaporator. The process of expansion to low pressure makes the refrigerant evaporate and thereby cool the evaporator.

A sensing device, called temperature tube signals the diaphragm in the expansion valve to change the size depending upon the refrigerant temperature at the evaporator outlet, thus achieving automatic temperature control (Fig. 3.38).



Fig 3.38: Air Conditioning System in a Car

Practical Exercises

A. Fill in the blanks

- _____ is the main component of a refrigeration system.
- Battery is used for _____ vehicle.
- Starting system consist of battery and starting _____.
- Warm temperature in the car is maintained by _____.

B. Multiple choice questions

- The starting motor is driven by means of the current taken from the _____.
 - battery
 - stabiliser
 - ignition coil
 - None of the above
- The function of the ignition system is _____.
 - to produce a spark in the engine combustion chamber
 - to generate, regulate and supply the electrical energy
 - to produce a current for charging
 - None of the above
- List the electrical accessories used in vehicle.

S. No.	List of accessories
1.	
2.	
3.	

- Air conditioner losses energy from the _____.
 - battery system
 - condenser
 - engine
 - None of the above

C. Short answer questions

- Discuss the importance of electrical and electronic system in automobiles.
- What are the components of an air conditioning system?

SESSION 11: ACTIVE AND PASSIVE SAFETY

There are different safety and security systems for automobiles available in the market and some of which are fitted by the manufacturer. Some of the active and passive security systems are mentioned as follows.

Safety Glass

Safety glass is used in all windows and doors of automotives. The safety glass used in today's vehicles is of two types—laminated and tempered. These are considered as safety glass because of their varying strength.

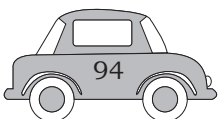

Laminated plate glass is used to make windshields. It consists of two thin sheets of glass with a thin layer of clear plastic between them. Some glass manufacturers increase the thickness of the plastic material for better strength. When this type of glass breaks, the plastic material tends to hold the shattered glass in place and thus, prevents it from causing injury.

Tempered glass is used for side and rear window glass but rarely for windshields. It is a single piece of heat-treated glass and has more resistance to impact than the regular glass of the same thickness. Thus, it has greater strength compared to a laminated plate glass.

Seat belts

A seat belt is also called a safety belt. It is a harness designed to protect the occupant of a vehicle from harmful movement, during a collision or when the vehicle stops suddenly.

A seat belt (Fig. 3.39) reduces the likelihood and severity of injury in a traffic collision. It prevents the vehicle occupant from hitting hard against the interior elements of the vehicle or other passengers, and keeps the occupants positioned in place for maximum benefit from the airbag.

The passenger must fasten the seat belt for crash protection. However, in case of a passive safety system, such as the inflation of air bags at the time of an accident, is automatic. No action is required of the occupant to make it functional. Nowadays, seat belts are also provided for rear seat occupants.



Fig. 3.39: Seat belt

Airbags

An airbag (Fig. 3.40) is one of the passive safety systems for the occupants of a four-wheeler. The electrical system of airbags includes impact sensors and an electronic control module. In case of an accident, the sensor detects the impact and the airbag opens up to save the driver and other occupants.



Fig. 3.40: Air bags

Energy-absorber Safety Bumpers

Modern bumpers are designed to absorb the energy of a low-speed impact, minimising the shock directed to the frame and to the occupants of the vehicle. Most energy absorbers are mounted between the bumper face bar or bumper reinforcement bar and the frame.

Security Devices

There are three basic types of security devices available — locking devices, disabling devices and alarm systems.

In automobile vehicle, an anti-theft system or device is installed to prevent theft of a vehicle. Many car security devices are available in the market. These are mechanical devices and ignition cut off devices, intelligent computerised anti-theft devices, satellite tracking system, engine control module, etc. Vehicle owners may select as per risk and install it in their vehicles. Prior to purchasing, the customers should check that these theft devices are duly approved from the Automobile Research Association of India (ARAI). Important features of these devices are explained below.

- **Alarm:** In the case of vehicle tampering, audible warning sounds emerge
- **Keyless Lock Device:** To use the vehicle, electronic coding device is required
- **Electronic Immobilisers:** These built-in transponders send signals to the ignition and fuel pump system. The vehicle remains in stationary or inoperable state if the ignition starters do not get correct signals.
- **Steering Wheel Lock:** This device is fitted in the steering of the vehicle and it locks it in one place so that no one can drive it without removing the lock.
- **Vehicle Tracking:** Even if a thief steals a vehicle, the tracking technologies can help trace it. Tracking devices offer real-time location of the stolen vehicle with the help of the global positioning system (GPS).

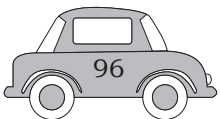

Practical Exercises

Activity 1

List the different active and passive safety devices.

S.No.	List of devices
1.	
2.	
3.	
4.	
5.	

Check Your Progress

A. Fill in the blanks

1. Air bags are used for _____.
2. Seat belt is also known as a _____ belt.
3. Passive safety system helps _____.
4. Active safety system is used for avoiding _____.

B. Multiple choice questions

1. Which types of anti-theft devices are available in a vehicle?
 - (a) Locking devices
 - (b) Disabling devices
 - (c) Alarm systems
 - (d) All of the above
2. Tempered glass is used for _____.
 - (a) side and rear window glass
 - (b) auto window and door
 - (c) head light
 - (d) All of the above
3. Which of these safety systems are operated automatically?
 - (a) Passive safety system
 - (b) Active safety system
 - (c) Energy-absorber safety
 - (d) None of the above
4. Impact sensors are used in _____.
 - (a) electrical system
 - (b) mechanical system
 - (c) auto-mechanical system
 - (d) None of the above

C. Short answer question

1. Discuss the components of the active and passive safety system.

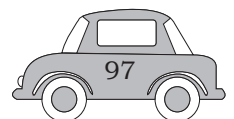

AUTOMOTIVE SERVICE TECHNICIAN - CLASS 9

UNIT 3 : MAJOR SYSTEMS AND COMPONENTS OF AN AUTOMOBILE

SESSION 1: CHASSIS AND AUTO BODY

Check Your Progress

A. Fill in the blanks

1. A chassis is almost a complete _____ mounting body.
2. The shape of the chassis depends _____ upon the ultimate use of the _____.

3. Major part of a chassis is the _____ frame.
4. In commercial vehicles like trucks and buses the body is not a _____ of the chassis.
5. In most of the cases, it is an open body, whereas for liquid material like water, milk and fuel a _____ is mounted on the chassis.

B. Multiple choice questions

1. Chassis is a French term and was initially used to denote _____.
(a) main structure of a vehicle
(b) fixing the automobile body
(c) transmission system, front and rear axle
(d) carrying the bolt
2. What are the functions of the chassis frame?
(a) To carry the weight of the vehicle and its passengers.
(b) To withstand the engine and transmission torque.
(c) To withstand the centrifugal force while cornering.
(d) All of the above
3. Automobile body is made of _____.
(a) sheet metal or fibre glass
(b) iron
(c) copper
(d) gun metal
4. The body is fixed to the chassis with the help of _____.
(a) I or U bolts
(b) rivet
(c) welding
(d) threaded bolt

5. Automobile body should fulfill which of the following requirements?

- (a) The body should be light.
- (b) It should have a long fatigue life.
- (c) Both (a) and (b)
- (d) None of the above

C. Short answer questions

1. Differentiate between chassis frame and automobile body.
2. Explain the use of the chassis frame.
3. How does auto body help in transport?

SESSION 2: ENGINE AND ITS COMPONENTS

Check Your Progress

A. Fill in the blanks

1. Engine is the _____ of an automobile. Its role is very important.
2. Engine converts the Chemical Energy (heat energy) to _____ Energy.
3. Major parts of engine are _____, _____, _____ and _____.
4. The function of the carburettor is to supply uniform _____ to the cylinder of a _____ through the intake manifold.
5. Sparkplug is used to _____.

B. Multiple choice questions

1. The compression-ignition engine air is compressed so that its temperature goes up to _____.
 - (a) 538 °C (1000 °F) or higher
 - (b) 348 °C
 - (c) 2480 °C
 - (d) None of the above

2. The cylinder of an IC engine is generally made of _____.
- (a) cast iron
 - (b) copper
 - (c) iron
 - (d) fibre
3. The charge (fuel and air mixture for SI engine and only air for CI engine) enters through the _____.
- (a) inlet valve
 - (b) spark plug
 - (c) outlet valve
 - (d) piston
4. The heart of the engine is the _____.
- (a) piston
 - (b) cylinder head
 - (c) connecting rod
 - (d) All of the above

C. Short answer questions

1. Explain the role of engine and its components.
2. Explain the difference between compression ignition engine and spark ignition engine?

SESSION 3: LUBRICATION SYSTEM

Check Your Progress

A. Fill in the blanks

1. Dry or solid friction is produced in _____.
2. Dry friction creates lot of _____.
3. The objective of lubrication is to reduce _____.
4. Lubrication provides _____ and _____ effect.

B. Multiple choice questions

1. Viscosity is measured using a _____.
(a) barometer
(b) thermometer
(c) viscometer
(d) fathometer
2. Lubricating oil is used for _____.
(a) minimising wear in moving parts
(b) help in keeping parts cool
(c) Both (a) and (b)
(d) None of the above
3. Which type of lubrication system is used in a two-stroke engine?
(a) petrol system
(b) wet sump system
(c) dry sump system
(d) All of the above
4. Viscosity index is a measure for the change of viscosity with change in _____.
(a) pressure
(b) temperature
(c) volume
(d) mass

C. Short answer questions

1. Explain the importance of lubrication in engine.
2. List the properties of lubricant.

SESSION 4: COOLING SYSTEM

Check Your Progress

A. Fill in the blanks

1. The cooling system removes excess _____ from the engine.
2. Cooling _____ a constant engine operating temperature.
3. The objective of cooling is to reduce _____.
4. Liquid cooling is employed in most _____ engines.

B. Multiple choice question

1. Which of the following type of cooling system is used in a motorcycle?
 - (a) Air cooling system
 - (b) Water cooling system
 - (c) Both (a) and (b)
 - (d) None of the above
2. The cooling fan is _____.
 - (a) driven by belt and pulleys
 - (b) fitted between the engine and the radiator
 - (c) driven from the camshaft
 - (d) All of the above
3. In water cooling, the water in the jacket obtains heat from the cylinder due to _____.
 - (a) conduction
 - (b) convection
 - (c) radiation
 - (d) All of the above

C. Short answer questions

1. How does a cooling system work?
2. What is the role of coolants?

SESSION 5: FUEL SUPPLY SYSTEM

Check Your Progress

A. Fill in the blanks

1. Air and fuel are _____ outside the engine.
2. The fuels, such as petrol, benzol and alcohol are used in _____ engine.
3. Oil fuels which are used in CI engines do not _____ easily.
4. The fuel system is controlled by the _____.

B. Multiple choice questions

1. Which of these is used as a fuel in IC engine?
(a) methanol
(b) LPG
(c) Benzoyl
(d) All of the above
2. The carburettor is used to _____.
(a) mix petrol and air in correct proportion
(b) supply fuel air mixture to the engine
(c) Both (a) and (b)
(d) None of the above
3. In a multi-point fuel injection the injector is used for how many cylinder engines?
(a) Five
(b) Two
(c) Four
(d) Six
4. Which of the following is not an injector fault?
(a) Blue nozzle body
(b) Nozzle wetness blue nozzle body
(c) Excessive leak off
(d) Blow holes

C. Short answer questions

1. Write the importance of a fuel supply system.
2. Explain the correct method of injecting fuel in an automobile.

SESSION 6: TRANSMISSION SYSTEM

Check Your Progress

A. Fill in the blanks

1. Transmission system consists of _____ components.
2. The main parts of a clutch are _____ and _____.
3. Different gear ratios in the _____ makes the vehicle move at different speeds.
4. The clutch assembly consist of flywheel, pressure plate and _____.

B. Multiple choice questions

1. Which of these systems is used in motor vehicles to supply the output of the internal combustion engine to drive wheels?
 - (a) Transmission system
 - (b) Power system
 - (c) Torque system
 - (d) None of the above
2. Which type of transmission system is used for a disengagement and engagement between the engine and the remainder of transmission system?
 - (a) Clutch
 - (b) Differential
 - (c) Propeller shaft
 - (d) None of the above
3. In a four-wheel drive there is _____.
 - (a) one live axle
 - (b) no live axle
 - (c) two live axle
 - (d) None of the above
4. _____ produces different gear ratios in automobiles.
 - (a) Transmission system
 - (b) Differential
 - (c) Steering
 - (d) Gear box

C. Short answer questions

1. Discuss the role of a transmission system.
2. Explain the function of a gear box.

SESSION 7: FRONT AND REAR AXLE

Check Your Progress

A. Fill in the blanks

1. Axle and steering system transmit _____ to the wheel.
2. Front and rear axle system is used for _____.
3. Differential mechanism enables the _____ to move faster than the inner wheel while taking a turn
4. Rear axle _____ the weight of vehicle body.

B. Multiple choice questions

1. The central portion of the front axle is made of _____.
(a) I section (b) T section
(c) Q section (d) U section
2. The end of the front axle is mounted with _____.
(a) stub axles (b) king pin
(c) piston ring (d) axle shaft
3. What kind of load does the axle take due to the load of the vehicle?
(a) Bending load (b) Frictional load
(c) Torsional load (d) None of these

C. Short answer questions

1. What is the role of a front axle?
2. Why are rear axles required?

SESSION 8: STEERING AND SUSPENSION SYSTEM

Check Your Progress

A. Fill in the blanks

1. Steering system is used for _____.
2. Main parts of steering system are _____ and steering column.
3. A suspension system consists of springs, _____ and linkages that connect a vehicle to its wheels.
4. A suspension system keeps vehicle occupants _____.

B. Multiple choice questions

1. The tilting of the front wheels away from the vertical is called _____.
 - (a) camber
 - (b) caster
 - (c) toe-in
 - (d) toe-out
2. Which of the following types of mechanism is used in a steering system?
 - (a) Rack and pinion steering
 - (b) Rotary motion is turning
 - (c) Reciprocating motion
 - (d) Power steering system
3. Leaf spring absorbs shocks by _____.
 - (a) tension
 - (b) compression
 - (c) twisting
 - (d) bending
4. Compressed air is used for _____.
 - (a) air suspension system
 - (b) hydraulic suspension
 - (c) mechanical suspension
 - (d) None of the above

C. Short answer questions

1. How does a steering system work?
2. What is a power steering system?

SESSION 9: WHEEL, TYRE AND BRAKE

Check Your Progress

A. Fill in the blanks

1. Wheel is an important component of the _____.
2. Tyre is fitted on the _____.
3. Brake should work _____ on roads.
4. Hand brake is also known as _____ brake.

B. Multiple choice questions

1. The most important component of a vehicle is _____.
(a) wheel
(b) rim
(c) disk
(d) tyre
2. The tyre is mounted on the _____.
(a) vehicle
(b) disc

- (c) wheel rim
(d) None of the above
3. The main component of the generating or charging system is (are) _____.
(a) generator/alternator
(b) ammeter
(c) the battery
(d) All of the above

C. Short answer questions

1. What are the components of a wheel?
2. How does the brake system function?

SESSION 10: ELECTRICAL OR ELECTRONIC AND AIR CONDITIONING SYSTEMS

Check Your Progress

A. Fill in the blanks

- _____ is the main component of a refrigeration system.
- Battery is used for _____ vehicle.
- Starting system consist of battery and starting _____.
- Warm temperature in the car is maintained by _____.

B. Multiple choice questions

- The starting motor is driven by means of the current taken from the _____.
(a) battery
(b) stabiliser
(c) ignition coil
(d) None of the above
- The function of the ignition system is _____.
(a) to produce a spark in the engine combustion chamber
(b) to generate, regulate and supply the electrical energy
(c) to produce a current for charging
(d) None of the above
- List the electrical accessories used in vehicle.

S. No.	List of accessories
1.	
2.	
3.	

- Air conditioner losses energy from the _____.
(a) battery system
(b) condenser
(c) engine
(d) None of the above

C. Short answer questions

- Discuss the importance of electrical and electronic system in automobiles.
- What are the components of an air conditioning system?

SESSION 11: ACTIVE AND PASSIVE SAFETY

Check Your Progress

A. Fill in the blanks

1. Air bags are used for _____.
2. Seat belt is also known as a _____ belt.
3. Passive safety system helps _____.
4. Active safety system is used for avoiding _____.

B. Multiple choice questions

1. Which types of anti-theft devices are available in a vehicle?
 - (a) Locking devices
 - (b) Disabling devices
 - (c) Alarm systems
 - (d) All of the above
2. Tempered glass is used for _____.
 - (a) side and rear window glass
 - (b) auto window and door
 - (c) head light
 - (d) All of the above
3. Which of these safety systems are operated automatically?
 - (a) Passive safety system
 - (b) Active safety system
 - (c) Energy-absorber safety
 - (d) None of the above
4. Impact sensors are used in _____.
 - (a) electrical system
 - (b) mechanical system
 - (c) auto-mechanical system
 - (d) None of the above

C. Short answer question

1. Discuss the components of the active and passive safety system.

Unit



Road Safety



17969CH04

INTRODUCTION

India ranks high when it comes to number of accidents on the road. However, in the recent years, improvement has been seen in this area. With the rapid increase in the number of vehicles on the road, the traffic conditions are under a lot of pressure. Therefore, road safety is one of the most serious public health issues in our country. It has an impact on everyone, whether one drives a vehicle, walks or rides a cycle.



Fig. 4.1: Road accident

Understanding Road Safety

Road safety refers to the measures which must be adopted by everyone while using roads. These safety methods are meant for reducing the risk of accidents and injuries or casualties on the road. These rules must be followed by all users of roads including pedestrians, cyclists, motorists, and bus and truck drivers. Safety methods also relate to the construction, layout of roads as well as traffic regulation systems. So, we can summarise that road safety involves:

- (i) the design of roads and highways;
- (ii) laws pertaining to traffic and vehicles;
- (iii) systems of traffic safety and control;
- (iv) driver education;
- (v) school students' education;
- (vi) mass education;
- (vii) traffic regulation and road safety signs;
- (viii) vehicle design; and
- (ix) motor vehicle safety inspection and maintenance.

Keeping our roads safe is not that difficult a task. Imagine if everyone follows simple safety measures and traffic rules, there will be no accident!

In this Unit, you will understand the various types of road safety measures to be adopted, and the importance of safety rules, road signs, traffic signals and rules, driving rules, registration and licensing adopted in our country.

SESSION 1: IMPORTANCE OF ROAD SAFETY

Road Safety

Some of the major causes of road accidents are as follows.

- (i) Lack of highway safety
- (ii) Drunken driving
- (iii) Driving in an exhausted state for long hours
- (iv) Using cell phone while driving
- (v) Overspeeding or rash driving

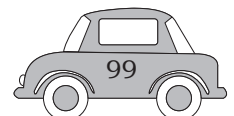

- (vi) Driving in wrong lanes
- (vii) Turning without giving signal
- (viii) Overtaking from wrong side

It can be seen that road safety is a collective responsibility. Therefore each one of us has to take steps required of us.

Role of Government and Public Sector

- (i) Develop stricter road safety polices
- (ii) Generate funds for road safety awareness
- (iii) Stricter enforcement of rules by government
- (iv) Building better roads and highways

Role of General Community

- (i) Acceptance of road safety rules, regulations and policies
- (ii) Participation in road safety awareness drives to enhance people's knowledge about road safety

Role of Education Sector

- (i) Inclusion of road safety modules in school curriculum
- (ii) Impart road safety education with the help of experts in this area
- (iii) Impart effective driver training for learners as well as existing drivers

Role of Media

- (i) Communicate road safety messages through print and electronic media
- (ii) Support road safety initiatives through responsible and objective reporting

Role of Health Professionals

- (i) Strengthen trauma facilities in our country.
- (ii) Organise workshops for saving the lives of people in road accidents.

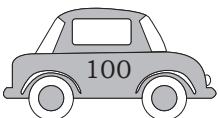

Improvement in Infrastructure

- (i) Adopt effective and safe traffic management measures while planning and designing infrastructure. For example, government approved road design, design of overbridges, road signages, etc.

Hurdles in Road Safety

- (i) Negligence by civilians
- (ii) Pathetic condition of roads
- (iii) Unsafe vehicle design
- (iv) Violation of road safety standards
- (v) Lack of emergency services
- (vi) Defects in highway designing

Some measures undertaken by the Road Safety Cell are

- (i) Publicity programmes
- (ii) Grants-in-aid to voluntary organisations for organising road safety programmes
- (iii) National Highway Accident Relief Service Scheme
- (iv) Refresher training to heavy vehicle drivers in unorganised sector
- (v) Setting up of Model Driving Training school
- (vi) Within the Ministry of Road Transport and Highways, massive road sector development programmes, such as observing Road Safety Week or conducting eye check-ups for truck drivers, the government is working closely with agencies like the World Bank, Asian Development Bank to improve road safety.

Road Safety Tips

Road safety is a result of efforts from all the sectors of the society including civilians and government officials. In addition to the human suffering, the estimated cost of road injuries is a noticeable amount in Gross National Product (GNP) per annum.

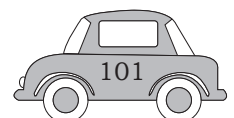

A few important road safety tips are mentioned below.

- (i) Do not use your mobile phone while driving.
- (ii) Use seatbelts even while sitting at the back seat of the vehicle.
- (iii) Do not drink and drive.
- (iv) Always adhere to the speed limit.
- (v) Take special care with regard to children, senior citizens and pedestrians.
- (vi) Do not drive if tired.
- (vii) Pedestrians should walk cautiously and make use of zebra crossing.
- (viii) Stay alert and observant while driving.
- (ix) Keep distance from other vehicles while driving.
- (x) Always wear helmets and seatbelts.



Fig. 4.2: Bicycle helmet



Fig. 4.3: Two-wheeler helmet

Safety Devices

Two-wheeler Helmet

A two-wheeler helmet (Figs 4.2, 4.3) is a type of protective headgear used by bicycle, motorcycle and scooter riders. The primary goal- of a two-wheeler helmet is to protect the rider's head during impact, thus preventing or reducing head injury or saving the rider's life. Some helmets provide additional conveniences, such as ventilation, face shields, ear protection, etc.

Of all the organs in our body, the heart and brain are the most vital ones. When a two-wheeler rider meets with an accident, it is the brain that is at a greater risk of injury. A brain injury can result due to skull fracture,

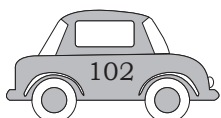

a concussion, brain haemorrhage, which can result in death.

Even if a part of the brain is damaged, it might result in the loss of speech or motor skills. In order to protect the brain, one must wear a helmet. A motorcycle helmet protects the skull and the brain from extensive damage.

Airbag

An airbag (see Unit 3, Fig. 3.40) is fitted in a four-wheeler to protect the driver and passengers during an accident.

Practical Exercises

Activity 1

List the safety rules which must be followed on road.

S. No.	Rules
1.	
2.	
3.	
4.	

Activity 2

Draw a road safety poster to be put up in your classroom.

Check Your Progress

A. Fill in the blanks

1. Accident takes places in our daily life due to lack of _____ measure.
2. Road safety is one of the nation's most serious _____ issues.
3. _____ is a result of efforts from all the sectors of the society.
4. Do not use your mobile phone while _____.
5. Important rules of road safety cannot be _____.

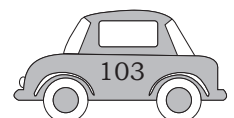

B. Multiple choice questions

1. Which safety device should be used while driving a two-wheeler?
 - (a) Helmet
 - (b) Seatbelt
 - (c) Airbags
 - (d) None of the above
2. Pedestrians should always cross the road using _____ crossing.
 - (a) zebra
 - (b) side road
 - (c) main road
 - (d) footpath

C. Short answer questions

1. List the road safety tips.
2. What are the safety devices used while driving a four-wheeler?

SESSION 2: SAFE AND RESPONSIBLE DRIVING

Getting Ready to Drive before Driving

- (i) Ensure that you are comfortable with your mental and physical condition.
- (ii) Inspect your vehicle and observe the driving conditions.

While driving, you should carry your driving licence, registration certificate, insurance certificate and pollution control certificate. Transport and commercial vehicle drivers should carry the permits and vehicle fitness certificates also.

A combination of knowledge, skill and attitude is required to be a safe driver.

- **Knowledge** of traffic rules and driving practices that help traffic move safely.
- **Skill** to care about the safety of others on the road. We all are responsible for avoiding accidents.
- **Attitude** to cooperate with other drivers to keep traffic moving safely. We must be courteous, giving

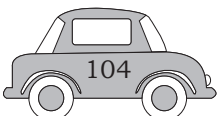

other drivers space to change lanes, not cutting them off and signalling before turning.



Fig. 4.5: Ill effects of drunken driving

Physical and Mental Alertness

One must be in good physical and mental condition before driving (Fig. 4.5).

Do not drive if you

- (i) have been drinking alcohol.
- (ii) take any medicine or drug that affects your responses.
- (iii) are tired, as it affects your driving skills and reaction time.
- (iv) are sick or injured.
- (v) are angry or upset.

In such conditions, you could be risking your life or lives of others on the road.

Know Your Vehicle

Go through the vehicle owner's manual.

You should know the features of the vehicle you are going to drive, for example, anti-lock brakes, four-wheel drive, etc.

Ensure that you know where the controls and instruments are and what they do. Check that all emergency signals and instruments work.

You should be able to turn on wipers, washers, headlights, indicators, etc., without having to look at them and without taking your eyes off the road.

Seating Position

Proper, upright position gives more stability while driving. Make sure you can see over the steering wheel and hood. You should be able to see the ground 1.5–2.0 metre in front of the vehicle for proper judgement.



Fig. 4.6: Sitting position

Sit straight and upright in the seat, with your elbows slightly bent. Adjust the seat (Fig. 4.6) so that your feet reach the pedals easily. Place your feet flat on the floor under the brake pedal. You are seated properly if you can do this.

Adjust the headrest to an appropriate height. It protects the head in case of collision.

Cars with air bags: It is important to note that an air bag cannot prevent injuries if the seating position is incorrect.

Know Your Blind Spots

Blind spot (Fig. 4.7) is an area on each side of the vehicle that you cannot see through the mirrors. Mostly blind

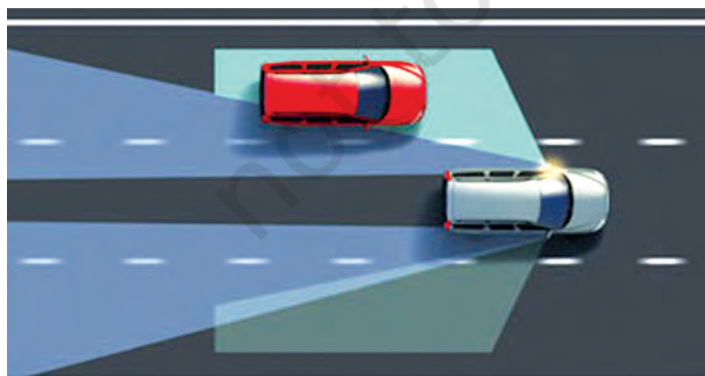
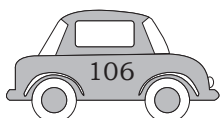

Fig. 4.7: Know your blind spots

spots are to the back left and back right of the vehicle. In Fig. 4.7, the red car is in the blind spot area of the silver car. The green areas show the blind spots of the silver car.

Adjust the mirrors to get the maximum view and identify your blind spots. You may not see vehicles when they are in these spots.



Position the interior mirror so that the centre of the mirror shows the centre of the rear window. When the interior mirror is properly adjusted, you would be able to see directly behind your vehicle (Fig. 4.8).

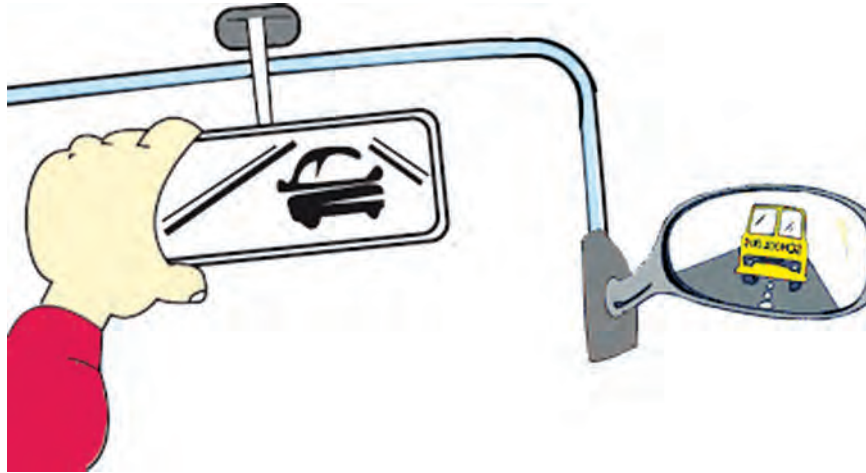

Fig. 4.8: Adjustment of interior mirror

The exterior (wing) mirror adjustment should be made while seated normally for driving. Do not set the right-hand exterior mirror by placing your head against the glass of the driver's door window. Do not adjust the left-hand exterior mirror by leaning to the centre of the vehicle.

Side mirrors show only narrow angles of view, so you have to turn your head to make sure there is nothing in your blind spots.

Fasten your Seat Belt

Fasten your seat belt before you start (Fig. 4.9). Seat belts are for safety and not just for avoiding *challans*.

Seat belts should be worn comfortable enough to keep you in your seat if there is a collision. Put the shoulder strap over your shoulder, never under your arm. The lap belt should be put low over the hips, not over the stomach.



Fig. 4.9: Fasten your seat belt



Fig. 4.10: Headlight at night

A seat belt saves life in the following ways.

- (i) It keeps you behind the wheel and in control of the vehicle in case of a collision.
- (ii) It keeps your head and body from hitting the inside of the vehicle.
- (iii) It keeps you inside the vehicle in case of a collision. A person who is thrown out of the vehicle during the collision has a higher chance of serious injury.

Turn on Headlights at Night and in Poor Light Conditions

Turn on headlights around 30 minutes before sunset and keep them on until 30 minutes after sunrise. Turn on your lights when fog or rain reduces your visibility to less than 100 metres.

Keep your headlights clean and get them adjusted regularly so that they enable clearer vision while driving. In dim light, use your headlights, not parking lights. Parking lights are only for parking.

High beams are banned in cities like Delhi, Chandigarh and other cities. You should not use high beams on roads. If you are travelling on a highway and using high beam headlights, switch to low beams within 150 metres of an incoming vehicle. Switch to your low beams when you are less than 60 metres behind another vehicle.

Practical Exercise

Activity 1

List the 'know your vehicle' rules followed in driving.

S. No.	Name of rules
1.	
2.	
3.	
4.	
5.	

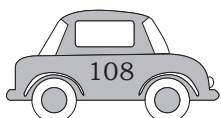

Check Your Progress

A. Fill in the blanks

1. Safety belt is used in _____.
2. Proper, upright position gives more _____ while driving.
3. Mental status before driving should be _____.
4. A combination of knowledge, skill and attitude is required to be a safe _____.
5. You should know the _____ of the vehicle you are going to drive.

B. Multiple choice questions

1. Mirror is adjusted to see the _____ view.
(a) maximum (b) minimum
(c) equal view (d) None of the above
2. What is the minimum age for driving a vehicle with a permanent licence?
(a) 14 (b) 16
(c) 18 (d) 20
3. Which areas on each side of the vehicle are not visible through the mirrors?
(a) Front spot (b) Blind spot
(c) Danger area (d) None of the above

C. Short answer question

1. Define 'blind spot'.

SESSION 3: ROAD SIGNS

Signals play an important role during smooth movement of traffic. Road signals are to be followed systematically, otherwise it may cause accidents.

Arm Signals

Arm signals are needed when a vehicle's indicators are not used, or when necessary to reinforce direction indicator signals and stop lights (Figs 4.11 [a]–4.11 [e]).

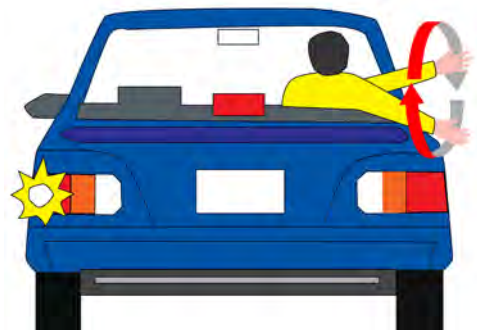

Fig. 4.11 (a): Intending to move to the left or turn left

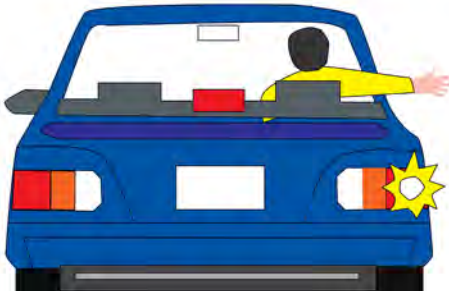

Fig. 4.11 (b): Intending to move out to the right or turn right



Fig. 4.11 (c): Intending to stop

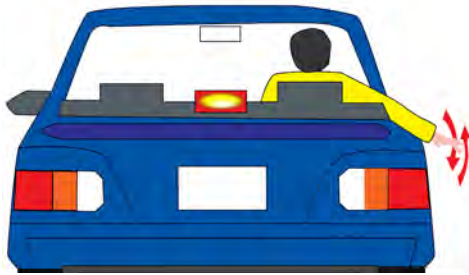

Fig. 4.11 (d): Intending to slow down

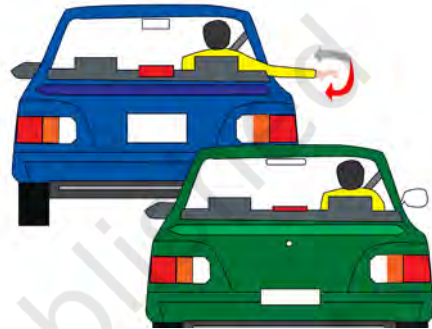

Fig. 4.11 (e): Indicating the car following you to overtake

Traffic Signs

Traffic signs are divided into three main categories.

- (i) Mandatory/regulatory signs
- (ii) Cautionary signs
- (iii) Information signs



Red circle instructs what should not be done.



Blue circle instructs what should be done.

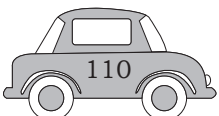



Triangle cautions



Blue rectangle informs

Typical Cautionary Signs



Right/Left Hand Curve: This sign is used where the direction of alignment changes. The sign forewarns the driver to reduce the speed and proceed cautiously along the road.



Right/Left Hair Pin Bend: This sign is used where the change in direction is so considerable that it amounts to reversal of direction. The symbol bends to right or left depending upon the road alignment.



Right/Left Reverse Bend: This sign is used where the nature of the reverse bend is not obvious to approaching traffic and constitutes a hazard. If the first curve is to the right, a right reverse bend shall be used. If the first curve is to the left, a left reverse bend is used.



Narrow Bridge: This sign is erected on roads in advance of bridges where the clear width between the wheel guards is less than the normal width of the carriageway.



Gap in Median: This sign is installed ahead of a gap in the median of a divided carriageway, other than an intersection.



Narrow Road: This sign is normally found in rural areas where a sudden reduction in the width of the pavement causes a danger to traffic.



Road Widens: This sign is normally found in rural areas where a sudden widening of road causes a danger to traffic, such as a two-lane road suddenly widening to a dual carriageway.



Cycle Crossing: This sign is erected in advance of all uncontrolled cycle crossings.



Pedestrian Crossing: This sign is erected in advance of both approaches to uncontrolled pedestrian crossings.



School: This sign is erected where school buildings or grounds are adjacent to the road, where traffic creates a hazard to children.

Men at Work: This sign is displayed only when men and machines are working on the road or adjacent to it or on overhead lines or poles. This sign is removed when the work is completed.

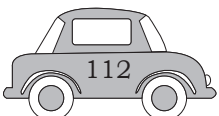



Side Road Left/Right: This sign is displayed in advance of the side road intersections where a large volume of entering traffic, together with restricted sight distance, is likely to constitute a hazard. The driver is warned of the existence of a junction.



Y-Intersection: These signs are displayed on the approach to a bifurcation of any road. This sign warns of the existence of a junction and no other indication is given.



Major Road: These signs are displayed in advance of a crossing with a major road, where a sufficiently large volume of traffic together, with restricted sight, is likely to cause a hazard.



Staggered Intersection: This sign is used to indicate junctions where the distance between two junctions is not more than 60 meters.



T Intersection: This sign is displayed in advance of T-junctions where the nature of intersection is not obvious to approaching traffic. This sign is used to warn the driver of the existence of a junction.



Start of Dual Carriageway: This sign is displayed when a single carriageway ends in a dual carriageway.



Reduced Carriageway: These signs caution the driver about the reduction in the width of the carriageway ahead. This is displayed on undivided carriageways when some portion of the carriageway is closed or reduced for repairs.

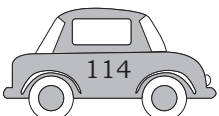



Two-way Operation: This sign is used to caution the driver of a changed pattern of traffic operation of the carriageway expected to carry traffic in one direction only.

Typical Cautionary Signs



Cattle: This sign is used where there is danger due to farm animals or cattle crossing the road.



Falling Rocks: This sign is used wherever rocks are liable to fall on the road seasonally or throughout the year. The symbol may be reversed to show the side from which rockfall is expected.

Lane Closure: This sign cautions the driver of the closure of a portion of the carriageway on multilane highways.





Barrier: This sign is erected in advance of a gate controlling entry into a road. A definition plate with words 'SLOW BARRIER AHEAD' or 'TOLL BARRIER AHEAD' is also displayed on the sign.



Roundabout: This sign is used where it is necessary to indicate the approach to a roundabout.



End of Dual Carriageway:

This sign is displayed when a dual carriageway ends and a single carriageway starts.

Cross Road: This sign is displayed in advance of the cross road where a sufficiently large volume of crossing or entering traffic with restricted sight distance is likely to constitute a hazard.

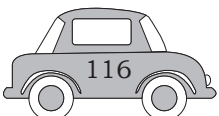



Traffic Diversion on Dual Carriageway: This sign warns the driver about the diversion of traffic from one carriageway to the other. It is used on dual carriageway when one carriageway is closed.



Ferry: This sign is used to warn the drivers about the existence of a ferry crossing across a river.



Loose Gravel: This sign is used on the section of road on which gravel may be thrown up by fast moving vehicles.



Overhead Cable: This sign cautions the driver about the presence of overhead power transmission lines.



Quarry Side or River Bank: This sign is used to caution the driver of the presence of water by the side of the road and impending danger.



Rough Road: This sign is posted where the road is rough and the drivers are required to slow down their vehicles for safe travel.



Runway: This sign is used to warn the drivers about the presence of a runway ahead and possible movement of aircraft.



Series of Bends: This sign is used to caution the driver about the presence of zigzag for a long distance over a section of road ahead.



Slippery Road: This sign is used to warn that the section of the road ahead may be particularly slippery.



Sudden Side Wind: This sign is used to caution the driver about the side winds which endanger the lives of travellers. This sign is posted at places where such weather conditions exist.



Traffic Signals: This sign is used to caution the drivers about the presence of traffic signals.



Unguarded Railway Crossing: This sign is used on the approaches of level crossings where there are no gates or other barriers. An advance warning sign (with two bars) is installed at a distance of 200 metres and second sign (with one bar) is installed near the crossing.



Guarded Railway Crossing: This sign is used to warn traffic on the approaches to guarded railway crossing. An advance warning sign (with two bars) is installed at a distance of 200 metres and a second sign (with one bar) is installed near the crossing.

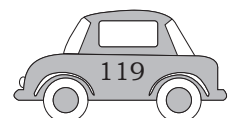



Steep Ascent or Steep Descent: This sign is displayed before a steep upgrade or downgrade that may constitute a hazard to traffic. A gradient of 10 per cent and above is considered steep gradient.



Rumble Strip: This sign is installed in advance of the rumble strips provided on the road to control the speed of the vehicle.



Dangerous Dip: This sign is used where a sharp dip in the profile of the road or a causeway is likely to cause considerable discomfort to traffic.



Speed Breaker: This sign warns the drivers about the presence of a speed breaker.

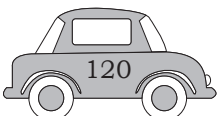

Parking Signs



Parking on this Side



Parking on both Sides



Scooter and Motor
Cycle Stand



Cycle Stand



Taxi Stand



Autorickshaw
Stand



Cycle-Rickshaw Stand

Speed Limit and Vehicle Control Signs



Speed Limit: This sign is erected at the beginning of the section of the road or area covered by a speed restriction, with numerals indicating the speed limit in kilometres per hour.



Width Limit: This sign is used where entry of vehicles exceeding a particular width is prohibited.



Height Limit: This sign is erected in advance of an overhead structure where entry is prohibited for vehicles whose height exceeds a certain limit.



Length Limit: This sign is used where entry of vehicles exceeding a particular length is prohibited.



Load Limit: This sign is used where entry of vehicles is prohibited for vehicles whose laden weight exceeds a certain limit.

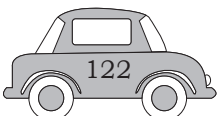



Axle Load Limit: This sign is used where entry of vehicles is prohibited for vehicles whose gross load exceeds a certain limit.

Prohibitory Signs

Straight Prohibited or No Entry: These signs are located at places where the vehicles are not allowed to enter. It is generally erected at the end of one-way road to prohibit traffic entering the roadway in the wrong direction and also at each intersection along the one-way road.



One way Sign: These signs are located at the entry to the one-way street and repeated at intermediate intersections on that street.

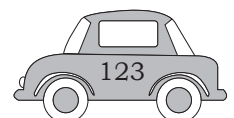



Vehicles Prohibited in Both Directions: This sign is used at the approach end of the roads where entry to all types of vehicular traffic is prohibited, especially in areas which have been designed as pedestrian malls.



Horn Prohibited: This sign is used on stretches of the road where using horn is not allowed, for example, near hospitals and in silence zones.



Cycle Prohibited: This sign is erected on each entry to the road where cycles are prohibited.



Pedestrian Prohibited: This sign is erected on each entry to the road where pedestrians are prohibited.

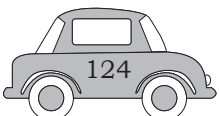



Right/Left Turn Prohibited: These signs are used at places where vehicles are not allowed to turn to the right or left. The signs are also used at the intersections of one-way street to supplement the one-way sign.



U-Turn Prohibited: This sign is used in places where vehicles are forbidden to make a turn to the reverse direction of travel between the sign and the next intersection beyond it.



Overtaking Prohibited: This sign is erected at the beginning of such sections of highways where sight distance is restricted and overtaking could be dangerous.



All Motor Vehicles Prohibited: This sign is used at places where entry to all types of motor vehicles is prohibited.



Trucks Prohibited: This sign is used at the entrance to the road where movement of trucks is prohibited.

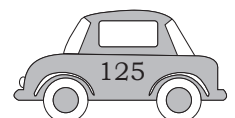



Hand Cart Prohibited:

This sign is erected on each entry to the road where hand carts are prohibited.



Bullock Cart Prohibited:

This sign is erected on each entry to the road where bullock carts are prohibited.



Tonga Prohibited: This sign is erected on each entry to the road where tongas are prohibited.



Bullock Carts and Hand Carts Prohibited: This sign is erected on each entry to the road where all types of slow moving vehicles except cycles are prohibited.

Stop and Give Way Signs



Stop Sign: This sign is used on roadways where traffic is required to stop before entering a major road. The vehicle shall proceed past the stop line only after ascertaining that this will not cause any damage to traffic on the main road.

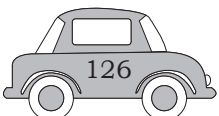



Give Way Sign: This sign is used to assign right-of-way to traffic on certain roadways and intersections, the intention being that the vehicles controlled by the sign must give way to the other traffic having the right-of-way.

Restriction End Sign



This sign indicates the point at which all prohibitions notified by the prohibitory signs for moving of vehicles cease to apply.

Compulsory Direction Control and Other Signs

Compulsory Turn Left/Right: These signs indicate the appropriate direction in which the vehicles are permitted to proceed.



Compulsory Ahead or Turn Left/Right: These signs indicate the appropriate directions in which the vehicles are permitted to proceed. Vehicles are supposed to move either of the given two directions.





Compulsory Ahead: This sign indicates that the vehicle is only permitted to proceed ahead.



Compulsory Keep Left: This sign is most frequently used on bollards or islands and refuges in the middle of the carriageway and at the beginning of central reserves of dual carriageway. The vehicles are obliged to keep left only.



Compulsory Cycle Rickshaw Track: This sign means only cycles and rickshaws are allowed on this road or carriageway.



Compulsory Sound Horn: This sign means the motor vehicles shall compulsorily sound horn at the location where the sign is placed. This sign is mostly put at sharp curves on hill roads.



Slip Road Ahead: This sign means the vehicles can either go straight or turn left.



Main Road Ahead: This sign means the vehicles can either go straight or turn right.

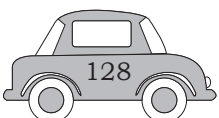



Pedestrians Only: This sign means that only pedestrians are allowed and the traffic is not allowed on this road or carriageway.



Buses Only: This sign means that only buses are allowed and other traffic is not allowed on this road or carriageway.

Practical Exercise

Activity 1

Draw 'Prohibitory' signs.





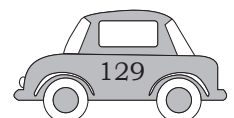

Check Your Progress

A. Fill in the blanks

1. A traffic sign helps in _____ movement of traffic.
2. The hand can also be used as _____ in emergency.
3. Signal traffic lights have _____, _____ and _____ colour.



B. Multiple choice questions

1. Sign of children near road shows possibility of _____ nearby.
(a) school
(b) park
(c) home
(d) hospital
2. Sign of  informs that _____.
(a) vehicle is prohibited in both directions
(b) vehicle prohibited in one direction
(c) vehicle prohibited in all directions
(d) None of the above
3. Signal of  shows _____.
(a) speed limit
(b) crossing
(c) distance
(d) None of the above
4. Sign shows  _____.
(a) guarded railway crossing
(b) unguarded railway crossing
(c) road crossing
(d) None of the above
4. Sign of  informs about _____.
(a) danger due to animals
(b) danger due to light
(c) danger due to forest
(d) None of the above

C. Short answer questions

1. Discuss the role of signal in road safety.
2. List some safety signs.

SESSION 4: DRIVING RULES AND REGISTRATION

The basic idea behind devising driving rules is to make the traffic more organised and safe. The Government of India has made driving rules for the citizens, which need to be followed by every citizen. Violation of the driving rules leads to fine or one can be asked to appear in front of the court. The driving rules and their number with penalty is explained next (these rules change from time to time).

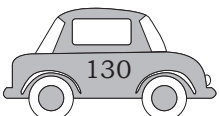

Driving Rules

Table 4.1: Traffic Offence and Penal Sections

S. No.	Offence	Penal Section	Compoundable or Non-compoundable	Fine Amount	Subsequent Fine Amount
1.	Driver without Uniform (in PSVs)	66.1/192A MV Act	Non Compoundable	To Court	To Court
2.	No Overtaking (General Motorists)	6 RRR/177 MV Act	Compoundable	100/-	300/-
3.	Smoking by Driver/ Conductor	DMVR 11.2/177 MV Act	Compoundable	100/-	300/-
4.	Park/Wait in Bus Lane/Bus Stand (General Motorists)	RRR15(2)/177 MV Act	Compoundable	100/-	300/-
5.	Open dala	RRR 16.1/177 MV Act	Compoundable	100/-	300/-
6.	One-way violation/ Driving against the flow of traffic	RRR 17(1)177 MV Act and 184 MV Act	Compoundable	100/- & 184 MV Act 1000/-	300/- & 2000
7.	Violation of Yellow Line (Central Verge)	18(11)RRR/119/177 MV Act	Compoundable	100/-	300/-
8.	Blowing of pressure horn	21 RRR/177 MV Act	Compoundable	100/-	300/-
9.	Conductor without PSV badge	66(1) 192A MV Act	Non Compoundable	To Court	To Court
10.	Giving alms to beggars or buying articles from hackers/vendors at intersection	22(a) RRR/177 MV Act	Compoundable	100/-	300/-
11.	Conductor without uniform	66(1)/192A MV Act	Non Compoundable	To Court	To Court
12.	Carrying high/long load	RRR 29/177 MV Act	Compoundable	100/-	300/-
13.	Advertisement on vehicle	DMVR 71.2/177 MV Act	Compoundable	100/-	300/-
14.	Cruelty with animal	DMVR 80/177 MV Act	Compoundable	100/-	300/-
15.	Carrying goods on passenger vehicle	DMVR 84(4)/177 MV Act	Compoundable	100/-	300/-
16.	Carrying passenger on goods vehicle	84(2) DMVR/177 & 184 MV Act	Compoundable	100/-	300/-
17.	Without log group	CMVR 85(10)/177 MV Act	Compoundable	100/-	300/-
18.	Smoking in the vehicle	DMVR 86.1(5)/177 MV Act	Compoundable	100/-	300/-
19.	Using horn in 'NO HONKING ZONE'	DMVR 96(1)/177 MV Act	Compoundable	100/-	300/-
20.	Use of coloured light on motor	DMVR 97(2)/177 MV Act	Compoundable	100/-	300/-

Contd...

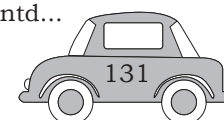

S. No.	Offence	Penal Section	Compoundable or Non-compoundable	Fine Amount	Subsequent Fine Amount
21.	Without valid PUC certificate	115 CMVR/ 190(2) MV Act	Compoundable	1000/-	2000/-
22.	Excess smoke	DMVR 99(1)(a)/177 MV Act	Compoundable	100/-	300/-
23.	Use of tinted glass	100(2) CMVR/177 MV Act	Compoundable	100/-	300/-
24.	Without wiper	CMVR 101/177 MV Act	Compoundable	100/-	300/-
25.	Playing of music in buses and use of DVD screen in private cars	102 DMVR/177 MV Act	Compoundable	100/-	300/-
26.	Driving without light after sunset	CMVR 105/177 MV Act	Compoundable	100/-	300/-
27.	Using siren	DMVR 107/177 MV Act	Compoundable	100/-	300/-
28.	Using high beam	112(4)(a)&(c)/177 MV Act	Compoundable	100/-	300/-
29.	Violation of stop line	113(1)DMVR/177 MV Act	Compoundable	100/-	300/-
30.	Violation of traffic signal	119/177 MV Act	Compoundable	100/-	300/-
31.	Violation of mandatory road signs	119/177 MV Act	Compoundable	100/-	300/-
32.	Driving without horn	CMVR 119.1/177 MV Act	Compoundable	100/-	300/-
33.	Driving left-hand drive indicator	120/177 MV Act	Compoundable	100/-	300/-
34.	Driving without silencer	CMVR 120/177 MV Act	Compoundable	100/-	300/-
35.	Obstructive/improper parking where police direction is indicated through a sign board of 'No Parking'	122/177 MV Act & 179 MV Act	Compoundable	100/-	300/-
36.	To travel on footboard	123/177 MV Act	Compoundable	100/-	300/-
37.	Travelling without Pass/Ticket	124/177 MV Act	Compoundable	100/-	300/-
38.	Obstructive driving (Extra Passenger on Driver Seat)	125/177 MV Act	Compoundable	100/-	300/-
39.	Triple riding on two-wheeler	128/177 MV Act	Compoundable	100/-	300/-
40.	Driver/Pillion rider without helmet	129/177 MV Act	Compoundable	100/-	300/-
41.	Not using seat belts	138(3) CMVR/177 MV Act	Compoundable	100/-	300/-

Contd...

AUTOMOTIVE SERVICE TECHNICIAN – CLASS IX

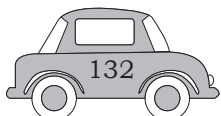

S. No.	Offence	Penal Section	Compoundable or Non-compoundable	Fine Amount	Subsequent Fine Amount
42.	Not displaying number Plate/Defective number plate/Fancy number plate	CMVR 50,51/177 MV Act & alongwith section 39/192 MV Act.	Compoundable	100/-	300/-
43.	Without HSRP	39/192 MV Act	Compoundable	4500/-	9000/-
44.	Permit holder/driver of contact carriage refuses to carry passengers	66(1)/192 MV Act	Non Compoundable	To court	to court
45.	To drive a vehicle without license	3/181 MV Act	Compoundable	500/-	-
46.	Allowing unauthorised person to drive vehicle	5/180 MV Act	Compoundable	1000/-	-
47.	Driving a vehicle without registration	39/192 MV Act	Compoundable	5000/-	10000/-
48.	Using unregistered vehicles or displaying applied for	39/192 MV Act	Compoundable	4500/-	9000/-
49.	Driving a vehicle without fitness	96/192 MV Act	Compoundable	5000/-	10000/-
50.	Not displaying the helpline number of State police and transport department in a bus	66/192-A MV Act	Non Compoundable	To court	To court
51.	Violation of Supreme Court directions violation of permit conditions	66/192-A MV Act	Non Compoundable	To court	To court
52.	Driving a vehicle without valid permit	66/192-A MV Act(Vehicle to be impounded for 15 days and not to be released until permit is renewed)	Non Compoundable	To court	To court
53.	Misbehaviour by TSR/ Taxi driver	66(1)/192-A MV Act	Non Compoundable	To court-	To court
54.	Overcharging by TSR/ Taxi	66(1)/192-A MV Act	Non Compoundable	To court	To court
55.	Refusal by TSR/Taxi driver	66(1)/192-A MV Act	Non Compoundable	To court	To court
56.	Overtaking to other commercial vehicle in running condition	66/192-A MV Act	Non Compoundable	To court	To court
57.	Picking passenger without stand	66.1/192-A MV Act	Non Compoundable	To court	To court
58.	Running in first lane (not in bus lane)	66.1/192-A MV Act	Non Compoundable	To court	To court

Contd...

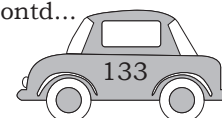

S. No.	Offence	Penal Section	Compoundable or Non-compoundable	Fine Amount	Subsequent Fine Amount
59.	Without speed governor	66.1/192-A MV Act	Non Compoundable	To court	To court-
60.	School bus without school board	66.1/192-A MV Act	Non Compoundable	To court	To court
61.	Bus not stopping within one meter of the kerb of the authorised bus stop	66.1/192-A MV Act	Non Compoundable	To court	To court
62.	Plying of bus with open doors	66.1/192-A MV Act	Non Compoundable	To court	To court
63.	To drive overweight vehicle	113/194 MV Act	Non Compoundable	To court	To court
64.	Violation of no entry timings by goods vehicles	115/194 MV Act	Non Compoundable	To court	To court
65.	Driving a vehicle without insurance	146/196 MV Act	Non Compoundable	To court	To court
66.	Violation of directions of a police officer and misbehaviour with a police officer	132/179 MV Act	Compoundable	500/-	-
67.	With holding of information	179 (2)	Compoundable	500/-	-
68.	Driving of vehicle by disqualified person	182(1)	Compoundable	500/-	-
69.	Disqualified conductor	182(2)	Compoundable	500/-	-
70.	Over speeding	112/183 MV Act	Compoundable	400/-	1000/-
71.	Causing the employee to drive at excessive speed	183(2)	Compoundable	300/-	500/-
72.	Driving dangerously	184 MV Act (or Case under section 279 IPC)	Compoundable	1000/-	2000/-
73.	Using mobile while driving a vehicle	184 MV Act	Compoundable	1000/-	2000/-
74.	Drive a vehicle after consuming intoxicants substances (narco-drugs), alcohol (violation of blood alcohol concentration over 3mg/100mL)etc.	185 MV Act	Non Compoundable	To court	To court

Contd...

AUTOMOTIVE SERVICE TECHNICIAN – CLASS IX

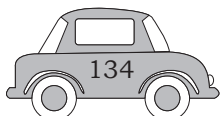

S. No.	Offence	Penal Section	Compoundable or Non-compoundable	Fine Amount	Subsequent Fine Amount
75.	Driving when mentally and physically unfit	186 MV Act	Compoundable	200/-	500/-
76.	Punishment relating to accidents	187 MV Act	Non Compoundable	To court	To court
77.	Racing and trials of speed	189 MV Act	Compoundable	500/-	-
78.	Air/noise pollution	190(2) MV Act	Compoundable	1000/-	2000
79.	Sale of vehicle in contravention of Act	191 MV Act	Compoundable	500/-	-
80.	To take away vehicle without permission	197 MV Act	Non Compoundable	To court	To court
81.	Unauthorized interference with vehicle	198 MV Act	Non Compoundable	To court	To court
82.	Without RUPD and LUPD	124 CMVR/190(2) MV Act	Compoundable	1000/-	2000/-

(Source: <https://delhitrafficpolice.nic.in/public-interface/traffic-offence/>)

Motor Vehicle Acts and Rules

MVA	Motor Vehicle Act, 1988
CMVR	Central Motor Vehicle Rules, 1989
DMVR	Delhi Motor Vehicle Rules, 1993

Registration

After a vehicle is purchased, it is registered with the State Transport office. All the districts have a Road Transport Office (RTO). RTO gives a registration number to all road vehicles. Every vehicle is fixed with a registration plate, commonly known as a number plate, which is placed in the front and back of the vehicle.

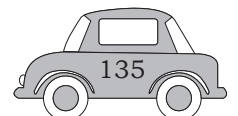

Registration Rules and Process

Necessity for Registration

No person shall drive any motor vehicle and no owner of motor vehicle shall cause or permit the vehicle to be driven in any public place or any other place, unless the vehicle is registered in accordance with Chapter 4 of IMV Act 1988.

Where to Register?

Every owner of a motor vehicle shall cause the vehicle to be registered by a registration authority in whose jurisdiction they have a residence or place of business where the vehicle is normally kept.

Temporary Registration

An application for temporary registration shall be made in Form 20 of the Central Motor Vehicle Rules, 1989 prescribed for Registration, under the Act marked 'Temporary' to the Registering Authority or to the dealer dealing in the sale of new motor vehicles recognised by the Transport Commissioner. It shall not be necessary to fill in the items 23 to 32 of the Form 20 in case of commercial vehicles like trucks.

Permanent Registration

An application for registration of a motor vehicle shall be made in Form 20 to the Registering Authority within a period of seven days from the date of delivery of such vehicle excluding the period of journey and shall be accompanied by Sales certificate in Form 21.

- (i) Road worthiness certificate in Form 22 from the manufacturers (Form 22A from the vehicle body manufacturer).
- (ii) Valid Insurance Certificate
- (iii) Proof of Address (Ration Card, Electricity Bill, etc.)
- (iv) Design approval copy of State Transport Authority in case trailer or semi-trailer
- (v) Original Sales Certificate from the concerned authorities in Form 21 in the case of ex-Army vehicle

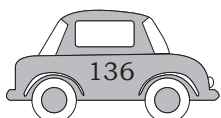

- (vi) Pollution under control certificate
- (vii) Customs' clearance certificate in case of imported vehicles
- (viii) Appropriate fee as specified in Rule 81 of CMV Rules

Practical Exercise

Activity 1

List the types of documents used in RTO office while registering a vehicle.

S. No.	Name of forms
1.	
2.	
3.	
4.	
5.	

Check Your Progress

A. Fill in the blanks

1. An application of temporary registration can be made in _____ of the Central Motor Vehicles Rules, 1989.
2. Vehicle registration is made at _____ office.
3. Vehicle registration is compulsory for driving _____.

B. Multiple choice questions

1. Red circle instructs _____.
 - (a) what should not be done
 - (b) what should be done
 - (c) what should be seen
 - (d) None of the above
2. Signal plays an important role during _____.
 - (a) smooth movement of traffic
 - (b) air traffic movement
 - (c) sea transport movement
 - (d) All of the above

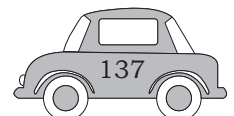

3. Right/Left Hand Curve sign is used where the direction of alignment _____.
 - (a) does not change
 - (b) changes
 - (c) is straight
 - (d) None of the above
4. Narrow arrow road sign is normally found _____.
 - (a) in rural areas
 - (b) in urban area
 - (c) in city area
 - (d) None of the above

C. Short answer questions

1. Why is registration required?
2. What are the different types of documents used in registration?
3. What are the advantages of using a driving license?

SESSION 5: DRIVING LICENCE

As you may be aware, while driving a vehicle the driver must have a valid document called driving licence or a driver's licence. It is an official document which states that a person may operate a motorised vehicle, such as a motorcycle, car, truck or a bus, on a public roadway. The minimum age for driving is 18 years for all vehicles, however motorcycle having engine capacity below 50 cc may be driven at the age of 16.

According to the Motor Vehicle Act 1988, a valid driving licence is necessary to drive any motor vehicle on public roads.

- (i) Driving Licence is issued by the Regional Transport Office (RTO) of Motor Vehicles Inspector's Office after the recipient has passed a driving test and has proved the required age.
- (ii) The Driving Licence in India is segregated as Motorcycle Licence, Light Motor Vehicle (LMV) Licence and Heavy Motor Vehicle (HMV) Licence.
- (iii) Learner's Licence is issued after passing a theory test.

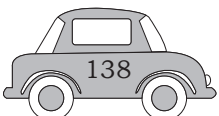

- (iv) The legislation of Driving Licence is done through the Rules of the Road Regulation and the Motor Vehicle Act, 1988.
- (v) The driver of the vehicle is required to keep the original copy of the licence while driving.

Types of Driving Licence in India

To drive a motor vehicle in any public place, a valid driving licence is necessary. A valid driving licence means the licence is issued to a person authorising them to drive the vehicle of that particular category. There are different types of licences issued by the RTO offices. Here we will discuss each of them separately.

(a) Learner Driving Licence

This is a temporary licence which is valid up to six months from the date of issue. It is basically issued to learn driving of motor vehicles.

(b) Permanent Driving Licence

Permanent driving licence is issued to those who become eligible for it after 30 days (to apply within 180 days) from the date of issue of the learner licence. The person supposed to get permanent driving licence should be conversant about the vehicle systems, driving, traffic rules and regulations.

(c) Duplicate Driving Licence

In case of loss, theft or on mutilation, a duplicate driving licence is issued. The documents to be produced are FIR of the lost licence, challan clearance report from RTA Office (in case of commercial licence renewal) and an application in Form LLD. The particulars are verified by the authority from the records. The duplicate licence has the same valid period as that of the previous licence. If the licence is lost and expired by more than six months, it requires permission from headquarters of the Transport Department.

It is recommended to keep a photocopy of the original licence or the particulars of the licence noted, in order to make it easier for the issuing authority to locate the particulars from their record.

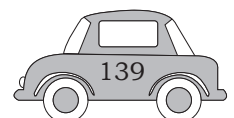

(d) International Driving Licence

The motor licencing authority also issues International Driving Licence. The validity of this licence is for one year. Person visiting the country is required to collect the licence from there within one year period. Apart from the address proof and birth certificate, one has to produce a valid passport and valid visa while applying.

(e) Motorcycle Licence or Two-wheeler Licence

A two-wheeler licence is issued by the Regional Transport Office (RTO) to permit driving of only two-wheeler vehicles like bike, scooter and moped.

(f) Light Motor Vehicle Licence (LMV)

Light Motor Vehicle Licence is issued to drive light vehicles like autorickshaws, motor car, jeep, taxi, three-wheeler delivery vans, etc.

(g) Heavy Motor Vehicle Licence (HMV)

Heavy Motor Vehicle Licence is issued to drive heavy vehicles like trucks, buses, tourist coaches, cranes, goods carriages, etc. A person with HMV licence can drive light vehicles but a Light Motor Vehicle Licence does not permit one to drive heavy vehicles.

Practical Exercises

Activity 1

List the different types of licences.

S. No.	Name of forms
1.	
2.	
3.	
4.	
5.	
6.	
7.	

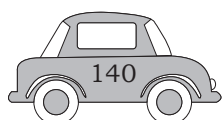

Check Your Progress

A. Fill in the blanks

1. Learner's License is issued after passing a _____ test.
2. RTO is office used for registration of _____
3. Driving license is made at _____ office.
4. License is compulsory for driving _____.
5. The minimum age for getting a learning license is _____.

B. Multiple choice questions

1. The full form of LMV is _____.
(a) Light Motor Vehicle
(b) Low Motor Vehicle
(c) Light Meter Vehicle
(d) None of the above
2. The full form of HMV is _____.
(a) Heavy Motor Vehicle
(b) High Motor Vehicle
(c) High Meter Vehicle
(d) None of the above
3. International Driving License is valid for _____.
(a) 1 year
(b) 2 years
(c) 3 years
(d) 4 years

C. Short answer questions

1. Why is a driving license required?
2. What are the different types of documents required to get a driving license?

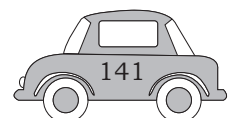

AUTOMOTIVE SERVICE TECHNICIAN - CLASS 9

UNIT 4 : ROAD SAFETY

SESSION 1: IMPORTANCE OF ROAD SAFETY

Check Your Progress

A. Fill in the blanks

1. Accident takes places in our daily life due to lack of _____ measure.
2. Road safety is one of the nation's most serious _____ issues.
3. _____ is a result of efforts from all the sectors of the society.
4. Do not use your mobile phone while _____.
5. Important rules of road safety cannot be _____.

B. Multiple choice questions

1. Which safety device should be used while driving a two-wheeler?
 - (a) Helmet
 - (b) Seatbelt
 - (c) Airbags
 - (d) None of the above
2. Pedestrians should always cross the road using _____ crossing.
 - (a) zebra
 - (b) side road
 - (c) main road
 - (d) footpath

C. Short answer questions

1. List the road safety tips.
2. What are the safety devices used while driving a four-wheeler?

SESSION 2: SAFE AND RESPONSIBLE DRIVING

Check Your Progress

A. Fill in the blanks

1. Safety belt is used in _____.
2. Proper, upright position gives more _____ while driving.
3. Mental status before driving should be _____.
4. A combination of knowledge, skill and attitude is required to be a safe _____.
5. You should know the _____ of the vehicle you are going to drive.

B. Multiple choice questions

1. Mirror is adjusted to see the _____ view.
(a) maximum (b) minimum
(c) equal view (d) None of the above
2. What is the minimum age for driving a vehicle with a permanent licence?
(a) 14 (b) 16
(c) 18 (d) 20
3. Which areas on each side of the vehicle are not visible through the mirrors?
(a) Front spot (b) Blind spot
(c) Danger area (d) None of the above

C. Short answer question

1. Define 'blind spot'.





SESSION 3: ROAD SIGNS

Check Your Progress

A. Fill in the blanks

1. A traffic sign helps in _____ movement of traffic.
2. The hand can also be used as _____ in emergency.
3. Signal traffic lights have _____, _____ and _____ colour.

B. Multiple choice questions

1. Sign of children near road shows possibility of _____ nearby.
(a) school
(b) park
(c) home
(d) hospital
2. Sign of  informs that _____.
(a) vehicle is prohibited in both directions
(b) vehicle prohibited in one direction
(c) vehicle prohibited in all directions
(d) None of the above
3. Signal of  shows _____.
(a) speed limit
(b) crossing
(c) distance
(d) None of the above
4. Sign shows  _____.
(a) guarded railway crossing
(b) unguarded railway crossing
(c) road crossing
(d) None of the above
4. Sign of  informs about _____.
(a) danger due to animals
(b) danger due to light
(c) danger due to forest
(d) None of the above

C. Short answer questions

1. Discuss the role of signal in road safety.
2. List some safety signs.

SESSION 4: DRIVING RULES AND REGISTRATION

Check Your Progress

A. Fill in the blanks

1. An application of temporary registration can be made in _____ of the Central Motor Vehicles Rules, 1989.
2. Vehicle registration is made at _____ office.
3. Vehicle registration is compulsory for driving _____.

B. Multiple choice questions

1. Red circle instructs _____
 - (a) what should not be done
 - (b) what should be done
 - (c) what should be seen
 - (d) None of the above
2. Signal plays an important role during _____.
 - (a) smooth movement of traffic
 - (b) air traffic movement
 - (c) sea transport movement
 - (d) All of the above
3. Right/Left Hand Curve sign is used where the direction of alignment _____.
 - (a) does not change
 - (b) changes
 - (c) is straight
 - (d) None of the above
4. Narrow arrow road sign is normally found _____.
 - (a) in rural areas
 - (b) in urban area
 - (c) in city area
 - (d) None of the above

C. Short answer questions

1. Why is registration required?
2. What are the different types of documents used in registration?
3. What are the advantages of using a driving license?

SESSION 5: DRIVING LICENCE

Check Your Progress

A. Fill in the blanks

1. Learner's License is issued after passing a _____ test.
2. RTO is office used for registration of _____.
3. Driving license is made at _____ office.
4. License is compulsory for driving _____.
5. The minimum age for getting a learning license is _____.

B. Multiple choice questions

1. The full form of LMV is _____.
(a) Light Motor Vehicle
(b) Low Motor Vehicle
(c) Light Meter Vehicle
(d) None of the above
2. The full form of HMV is _____.
(a) Heavy Motor Vehicle
(b) High Motor Vehicle
(c) High Meter Vehicle
(d) None of the above
3. International Driving License is valid for _____.
(a) 1 year
(b) 2 years
(c) 3 years
(d) 4 years

C. Short answer questions

1. Why is a driving license required?
2. What are the different types of documents required to get a driving license?

Unit



Automobile and Environment



17969CH05

INTRODUCTION

Pollution is a big concern to the human race today. We are not able to conserve our environment properly, and if we do not act upon it, our natural resources will soon get depleted. Pollution in any form is dangerous, be it pollution of air, water or noise, and therefore, it needs to be controlled to save our environment. It is necessary for us to adopt national and international emission standards which ensure better utilisation of resources and help in controlling pollution. Governments all over the world are now serious about environment, and therefore, we get emission standards to follow in design and maintenance of automobiles. All the products and services have to follow national standards. Nowadays, strict measures are being taken by car designers to adopt Bharat Standard (BS). You may have noticed BS-IV written on vehicles. This is the latest version of emission standards followed in India. Similarly, all the vehicles are supposed to carry PUC (Pollution Under Control) certificate so that pollution is controlled. A visit to a nearby petrol pump would help you observe how pollution coming out of an automobile is checked.

In this Unit, we will understand air pollution, auto emission standards like EU/BS, PUC certification and ways to control pollution.

SESSION 1: AIR POLLUTION

Human population has grown enormously over the last 100 years, and so has the demand for food, water, home, electricity, roads, automobiles and numerous other commodities. These increasing demands exert tremendous pressure on our natural resources, and also contribute to pollution of air, water and soil. The need of the hour is to check the degradation and depletion of our precious natural resources and pollution without halting the process of development.

Pollution is an undesirable change in physical, chemical or biological characteristics of air, land, water or soil. Agents that bring about such an undesirable change are called pollutants. In order to control environmental pollution, the Government of India has passed the Environment (Protection) Act, 1986 to protect and improve the quality of our environment (air, water and soil).

Air Pollution and Its Control

We are dependent on air for our respiratory needs. Air pollutants cause injury to all living organisms. They reduce growth and yield of crops and cause premature death of plants. Air pollutants (Fig. 5.1) also deleteriously affect the respiratory system of humans and animals. Harmful effects depend on the concentration of pollutants, duration of exposure and the organism. Smokestacks of thermal power plants, smelters and other industries release particulate and gaseous air pollutants together with harmless gases, such as nitrogen, oxygen, etc. These pollutants must be separated and filtered out before releasing the harmless gases into the atmosphere.



Fig. 5.1: Air pollution

Automobiles are also a major cause for atmospheric pollution at least in the metro cities. The badly designed and badly maintained automobiles are a major cause of air pollution. You may have seen buses, trucks, cars or tempos releasing black smoke. This happens because of poor maintenance of the vehicle, and due to this, the engine does not burn the fuel completely or properly. It can also happen because of improper mixture of air and fuel or when poor quality of fuel is used.

As a result of the increasing number of vehicles on the roads, air pollution is shifting to the other cities as well. Proper maintenance of automobiles along with the use of lead-free petrol or diesel can reduce the pollutants they emit. Catalytic converters, having expensive metals, namely platinum-palladium and rhodium as the catalysts, are fitted into automobiles for reducing emission of poisonous gases. As the exhaust passes through the catalytic converter, unburnt hydrocarbons are converted into carbon dioxide and water. Also, carbon monoxide and nitric oxide are changed to carbon dioxide and nitrogen gas, respectively. Motor vehicles equipped with catalytic converter should use unleaded petrol because lead in petrol reduces the effectiveness of the catalyst.

Controlling Vehicular Air Pollution: A Case Study of Delhi

With its large population of vehicular traffic, Delhi leads the country in its levels of air pollution — it has more cars than in the states of Gujarat and West Bengal put together. In the 1990s, Delhi ranked fourth among the 41 most polluted cities of the world. Air pollution problems in Delhi became so serious that a public interest litigation (PIL) was filed in the Supreme Court of India in 1985. After being censured very strongly by the Supreme Court, under its directives, the government was asked to take, within a specified time period, appropriate measures, including switching over the entire fleet of public transport, i.e., buses, from diesel to compressed natural gas (CNG).

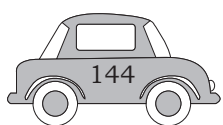

The Government of Delhi decided to convert all the state-run buses to CNG by the end of 2002. This resulted in a dramatic improvement in the pollution levels.

You might be curious to know why CNG is better than diesel. The answer is that CNG burns more efficiently and completely. On the other hand, petrol or diesel are partly left unburnt. Moreover, CNG is cheaper than petrol or diesel, cannot be siphoned off by thieves and cannot be adulterated like petrol or diesel. The main problem with switching over to CNG is the difficulty of laying down pipelines to deliver CNG through distribution points or pumps and ensuring uninterrupted supply. Therefore, you may have noticed long queues of vehicles at CNG stations.

Simultaneously, steps are being taken for reducing vehicular pollution which include phasing out of old vehicles, use of unleaded petrol, use of low-sulphur petrol and diesel, use of catalytic converters in vehicles, application of stringent pollution level norms for vehicles, etc.

The Government of India through a new auto fuel policy has made a plan to cut down vehicular pollution in Indian cities. More stringent norms for fuels means steadily reducing the sulphur and aromatic content in petrol and diesel fuels. Euro II norms, for example, stipulate that sulphur be controlled at 350 parts-per-million (ppm) in diesel and 150 ppm in petrol. Aromatic hydrocarbons are to be contained at 42 per cent of the concerned fuel. The goal, according to the roadmap, is to reduce sulphur to 50 ppm in petrol and diesel and bring down the level to 35 per cent. Corresponding to the fuel, vehicle engines also need to be upgraded.

All automobiles and fuel — petrol and diesel, were to have met the Euro III emission specifications in these 11 cities from 1 April 2005 and have to meet the Euro IV norms by 1 April 2010. The rest of the country were required to have Euro III emission norm-compliant automobiles and fuels by 2010. Now, Delhi-NCR regions have started using ultra-clean Bharat Stage VI grade fuel (both petrol and diesel). Other cities like Noida, Ghaziabad, Gurugram and Faridabad along with 13

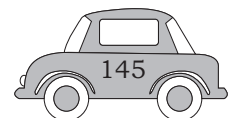

major cities, including Mumbai, Chennai, Bengaluru, Hyderabad and Pune, are also said to switch over to cleaner BS-VI grade fuel from 2019 onwards. However, BS-VI fuel will be rolled out in rest of the country by April 2020. These efforts have resulted in improved air quality in some cities like Delhi. According to an estimate, a substantial fall in CO₂ (carbon dioxide) and SO₂ (sulphur dioxide) levels has been found in Delhi between 1997 and 2005. This has been possible by introducing CNG buses on the roads.

Practical Exercise

Activity 1

List the reasons for air pollution.

S. No.	Reasons for air pollution
1.	
2.	
3.	
4.	
5.	

Check Your Progress

A. Fill in the blanks

- The need of the hour is to check the _____ and _____ of our precious natural resources.
- In order to control environmental pollution, the Government of India has passed the _____ Act, 1986 to protect and improve the quality of our _____ (air, water and soil).
- Air pollutants deleteriously affect the _____ system of humans and of animals.
- The full form of CNG is _____.
- Automobiles are a major _____ of atmospheric pollution.

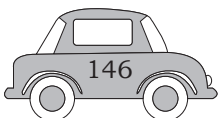

6. Euro II norms, for example, stipulate that sulphur be controlled at _____ parts-per-million (ppm) in diesel and _____ ppm in petrol.

B. Multiple choice questions

1. The latest version of emission standards to be followed in India are _____.
 - (a) BS-IV
 - (b) BS-III
 - (c) BS-II
 - (d) EURO-III
2. A substantial fall of which gases level was found in Delhi between 1997 and 2005 due to CNG?
 - (a) CO_2 and SO_2
 - (b) Co_2 and Sio_2
 - (c) CO and SO_2
 - (d) None of the above
3. An undesirable change in physical, chemical or biological characteristics of air, land, water or soil is known as _____.
 - (a) population
 - (b) pollution
 - (c) propulsion
 - (d) None of the above
4. The Government of Delhi decided to convert all the buses to CNG by the end of year _____.
 - (a) 2022
 - (b) 2016
 - (c) 2002
 - (d) 2006

C. Short answer questions

1. Why is it important to control air pollution?
2. What is the role of a convertor in an automobile?
3. How has CNG helped in controlling pollution?

SESSION 2: AUTO EMISSIONS AND EU/BS STANDARDS

You may have noticed black or white smoke coming out from car, scooter, tempo or truck. This smoke is a by-product of the combustion process and from evaporation of fuel itself. It is known as auto emission (see Fig. 5.2).

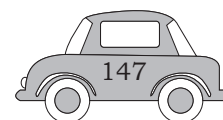



Fig. 5.2: Auto emission

Auto Emissions

When emission from automobiles carry unburnt hydrocarbons, it causes air pollution. Pollution from cars comes from by-products of this combustion process (exhaust) and from evaporation of the fuel itself.

Combustion Process

Petrol and diesel fuels are mixtures of hydrocarbons, compounds which contain hydrogen and carbon atoms. In a 'perfect' engine, oxygen in the air converts all the hydrogen in the fuel to water and all the carbon in the fuel to carbon dioxide. Nitrogen in the air remains unaffected. In reality, the combustion process cannot be

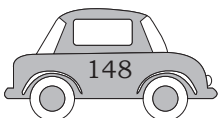

'perfect', and therefore, automotive engines emit several type of pollutants.

Emission Standards

Governments and regulatory bodies all over the world discuss with automobile companies and list down requirements that set specific limits to the amount of pollutants that can be released into the environment. Many emission standards focus on regulating pollutants released by automobiles (motor cars) and other powered vehicles, but they can also regulate emissions from industry, power plants, small equipment, such as lawn mowers and diesel generators. Frequent policy alternatives to emission standards are technology standards (which mandate the regulation of emissions of nitrogen oxides [NO_x], sulphur oxides, particulate matter [PM] or soot, carbon monoxide [CO], or volatile hydrocarbons).

Emission Norms in India

With the increasing number of vehicles on the roads, the possibility of large scale pollution due to these vehicles has also increased. However, the pollution can be reduced considerably if the vehicles are designed and maintained as per regulations.

It was only in 1991 that the first stage emission norms came into force for petrol vehicles, and in 1992, for diesel vehicles. From April 1995, mandatory fitting of catalytic converters in new petrol passenger cars sold in the four metros of Delhi, Kolkata, Mumbai and Chennai, along with a supply of Unleaded Petrol (ULP) was brought into effect. Availability of ULP was further extended to 42 major cities and now it is available throughout the country.

The emission reduction achieved from pre-1989 levels is over 85 per cent for petrol-driven and 61 per cent for diesel vehicles from 1991 levels.

In the year 2000, passenger cars and commercial vehicles started meeting Euro I equivalent India 2000 norms. Euro II equivalent Bharat Stage II norms are in

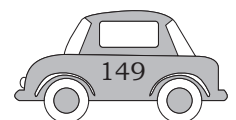

force from 2001 in the four metros of Delhi, Mumbai, Chennai and Kolkata.

India is still behind Euro norms by a few years. These are standards followed by European countries. However, with many vehicles manufactured in India now being exported, a beginning has been made, and emission norms are being aligned with Euro standards and vehicular technology is being accordingly upgraded. Indian vehicle manufactures are also working towards bridging the gap between Euro standards and Indian emission norms.

Bharat stage emission standards are emission standards instituted by Government of India to regulate the output of air pollutants from internal combustion engine equipments, including motor vehicles. The standards and the timeline for implementation are set by the Central Pollution Control Board under the Ministry of Environment, Forests and Climate Change.

Nowadays, India has adopted Bharat Stage IV norms in the automobile sector. For metro cities, it has become compulsory to use the standard product.

The implementation schedule of EU emission standards in India is presented in Table 5.1.

Standard	Reference	Date	Region
India 2000	Euro 1	2000	Nationwide
Bharat Stage II	Euro 2	2001	NCR*, Mumbai, Kolkata, Chennai
		2003.04	NCR*, 11 Cities†
		2005.06	Nationwide
Bharat Stage III	Euro 3	2005.06	NCR*, 11 Cities†
		2010.14	Nationwide
Bharat Stage IV	Euro 4	2010.14	NCR*, 11 Cities†
* National Capital Region (Delhi)			
† Mumbai, Kolkata, Chennai, Bengaluru, Hyderabad, Secunderabad, Ahmedabad, Pune, Surat, Kanpur and Agra			

The above standards apply to all the new four-wheeler vehicles sold and registered in the respective regions.

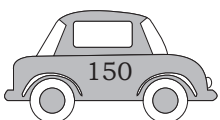

In addition, the National Auto Fuel Policy introduces certain emission requirements for interstate buses with routes originating or terminating in Delhi or the other 10 cities.

For two- and three-wheelers, Bharat Stage II has been applicable since 1 April 2005 and Stage III standards came into force from 1 April 2010.

Practical Exercise

Activity 1

List the reasons for auto emission.

S. No.	Reasons for Emission
1.	
2.	
3.	
4.	
5.	

Check Your Progress

A. Fill in the blanks

1. Burning of fuel takes place in the _____ of automobile to give power to the vehicle.
2. Smoke is the by-product of the _____ process.
3. First stage emission norms came into force for petrol vehicles in the year _____.
4. Emission reduction achieved from pre-89 levels is _____ for petrol driven and _____ for diesel vehicles from 1991 levels.
5. Euro II equivalent Bharat Stage II norms are in force from 2001 in the four metros of _____, _____, _____ and _____.

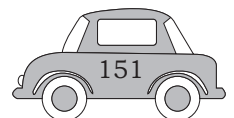

B. Multiple choice questions

1. Petrol and diesel fuels are mixtures of _____.
(a) hydrocarbons
(b) carbons
(c) nitrogen
(d) carbon monoxide
2. Government standards generally regulate the emissions of _____.
(a) nitrogen oxides (NO_x)
(b) sulphur oxides (SO_x)
(c) particulate matter (PM) or soot
(d) All of the above
3. In a 'perfect' engine, oxygen in the air would convert all the hydrogen in the fuel to _____.
(a) water
(b) gases
(c) smoke
(d) pollution

C. Short answer questions

1. Why is emission control important?
2. What is Bharat Standard or Euro Standard?

SESSION 3: PUC CERTIFICATION

In this session, we will learn about various aspects of automobile pollution and measures taken to control pollution (Fig. 5.3).



Fig. 5.3: PUC unit

Adulteration of fuel leads to the weak combustion process which ultimately leads to pollution. You may have read in the newspaper that some petrol-pump owners adulterate petrol with kerosene to get higher margin of profit. It causes incomplete combustion and leads to air pollution from vehicles using such adulterated petrol.

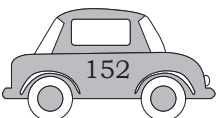

Proper maintenance of vehicles keeps a check on pollution by reducing the emission. Adequate measures have been taken to improve the quality of fuel, for example, lead-free fuel, CNG fuel, biofuel, etc., are being adopted in the automobile sector.

Hence, the quality of fuel plays an important role in meeting the stringent emission regulation. The fuel specifications of petrol and diesel have been aligned with the corresponding European fuel specifications for meeting the Euro II, Euro III and Euro IV emission norms.

The use of alternative fuels has been promoted in India both for energy security and emission reduction. Delhi and Mumbai have more than 1,00,000 commercial vehicles running on CNG fuel. Delhi has the largest number of CNG commercial vehicles running anywhere in the world. India is planning to introduce biodiesel, ethanol and gasoline blends in a phased manner, and has drawn up a roadmap for the same.

The Indian auto industry is working with the authorities to facilitate introduction of alternative fuels. India has also set up a taskforce for preparing the hydrogen roadmap. The use of LPG (liquid petroleum gas) has also been introduced as an auto fuel and the oil industry has drawn up plans for setting up of auto LPG dispensing stations in major cities.

Pollution Under Control (PUC) Certificate

Presently, all vehicles need to undergo a periodic emission check (three months or six months) at PUC centres at fuel stations and private garages which are authorised to check the vehicles. It is mandatory for every vehicle owner to carry a valid Pollution Under Control (PUC) Certificate and maintain the vehicle within the prescribed emission norms.

You may have seen the computerised facilities for checking pollution levels and issuing of PUC Certificates (to vehicles meeting emission standards) at petrol pumps. These authorised pollution checking centres are spread in all cities. At present, a number of centres for petrol-driven vehicles and diesel-driven

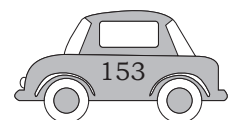

vehicles are functioning. These centres issue Pollution Under Control (PUC) certificates if the vehicles meet the prescribed emission norms. In case a vehicle is found polluting beyond prescribed norms, necessary repairs and tuning in the vehicle are required.

If a vehicle does not have a valid PUC certificate, then its owner is liable to be prosecuted under Section 190(2) of the Motor Vehicles Act. A penalty of ₹1,000/- for the first offence and ₹2,000/- for every subsequent offence of violation has been provided.

Fee for pollution checking is fixed by the State Transport Department and is quite nominal.

Petrol/CNG/LPG vehicle: ₹ 25

Diesel vehicle: ₹50

Minor adjustment (Carburetted petrol vehicles only): ₹5

Despite having a valid PUC certificate, if a vehicle is found polluting the environment, then the PUC certificate of the vehicle is cancelled and its owner is directed (under Rule 116 of CMV Rules) to produce a fresh PUC certificate within seven days. The failure to comply with this direction results in prosecution under Section 190(2) of the Motor Vehicles Act. If the vehicle is not polluting and the PUC Certificate has expired or one does not have a PUC certificate, then also offence of not having a PUC certificate attracts prosecution under Section 190(2) of the Motor Vehicles Act.

There are regulations also that require transport vehicles to undergo an annual fitness check carried out by RTOs for emissions, safety and road worthiness. Now the government is also preparing plans for compulsory inspection of vehicles after a certain number of years.

Some other ways to control pollution are:

- (i) keeping car one day off in a week.
- (ii) car pooling for going to office.
- (iii) using bicycle for short distances.
- (iv) maintaining the vehicle properly maintained.
- (v) using public transport to commute. Delhi Metro is the best example of controlling pollution and providing comfort to the public.

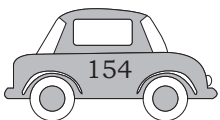

Practical Exercises

Activity 1

List the reasons for controlling pollution.

S. No.	Reasons for controlling air pollution
1.	
2.	
3.	
4.	
5.	
6.	

Check Your Progress

A. Fill in the blanks

1. The new alternate fuel used in Delhi is _____.
2. Meaning of PUC is _____.
3. PUC is checked at _____.
4. The full form of CNG is _____.
5. Adulteration of fuel leads to _____ combustion process.

B. Multiple choice questions

1. Which state of India has the largest number of CNG commercial vehicles running in comparison to anywhere else in the world?
(a) Maharashtra (b) Punjab
(c) Delhi (d) Gujarat
2. India has setup a task force for preparing the _____.
(a) carbon road map (b) oxygen road map
(c) hydrogen road map (d) hydrocarbon road map

C. Short answer questions

1. What is the purpose of having PUC?
2. List some tips for controlling pollution.

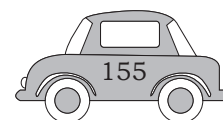

AUTOMOTIVE SERVICE TECHNICIAN - CLASS 9

UNIT 5 : AUTOMOBILE AND ENVIRONMENT

SESSION 1: AIR POLLUTION

Check Your Progress

A. Fill in the blanks

1. The need of the hour is to check the _____ and _____ of our precious natural resources.
2. In order to control environmental pollution, the Government of India has passed the _____ Act, 1986 to protect and improve the quality of our _____ (air, water and soil).
3. Air pollutants deleteriously affect the _____ system of humans and of animals.
4. The full form of CNG is _____.
5. Automobiles are a major _____ of atmospheric pollution.

6. Euro II norms, for example, stipulate that sulphur be controlled at _____ parts-per-million (ppm) in diesel and _____ ppm in petrol.

B. Multiple choice questions

1. The latest version of emission standards to be followed in India are _____.
 - (a) BS-IV
 - (b) BS-III
 - (c) BS-II
 - (d) EURO-III
2. A substantial fall of which gases level was found in Delhi between 1997 and 2005 due to CNG?
 - (a) CO_2 and SO_2
 - (b) Co_2 and Sio_2
 - (c) CO and SO_2
 - (d) None of the above
3. An undesirable change in physical, chemical or biological characteristics of air, land, water or soil is known as _____.
 - (a) population
 - (b) pollution
 - (c) propulsion
 - (d) None of the above

4. The Government of Delhi decided to convert all the buses to CNG by the end of year _____.
- (a) 2022
 - (b) 2016
 - (c) 2002
 - (d) 2006

C. Short answer questions

1. Why is it important to control air pollution?
2. What is the role of a convertor in an automobile?
3. How has CNG helped in controlling pollution?

SESSION 2: AUTO EMISSIONS AND EU/BS STANDARDS

Check Your Progress

A. Fill in the blanks

1. Burning of fuel takes place in the _____ of automobile to give power to the vehicle.
2. Smoke is the by-product of the _____ process.
3. First stage emission norms came into force for petrol vehicles in the year _____.
4. Emission reduction achieved from pre-89 levels is _____ for petrol driven and _____ for diesel vehicles from 1991 levels.
5. Euro II equivalent Bharat Stage II norms are in force from 2001 in the four metros of _____, _____ and _____.

B. Multiple choice questions

1. Petrol and diesel fuels are mixtures of _____.

 - (a) hydrocarbons
 - (b) carbons
 - (c) nitrogen
 - (d) carbon monoxide

2. Government standards generally regulate the emissions of _____.
 - (a) nitrogen oxides (NO_x)
 - (b) sulphur oxides (SO_x)
 - (c) particulate matter (PM) or soot
 - (d) All of the above
3. In a 'perfect' engine, oxygen in the air would convert all the hydrogen in the fuel to _____.
 - (a) water
 - (b) gases
 - (c) smoke
 - (d) pollution

C. Short answer questions

1. Why is emission control important?
2. What is Bharat Standard or Euro Standard?

SESSION 3: PUC CERTIFICATION

Check Your Progress

A. Fill in the blanks

1. The new alternate fuel used in Delhi is _____.
2. Meaning of PUC is _____.
3. PUC is checked at _____.
4. The full form of CNG is _____.
5. Adulteration of fuel leads to _____ combustion process.

B. Multiple choice questions

1. Which state of India has the largest number of CNG commercial vehicles running in comparison to anywhere else in the world?
 - (a) Maharashtra
 - (b) Punjab
 - (c) Delhi
 - (d) Gujarat
2. India has setup a task force for preparing the _____.
 - (a) carbon road map
 - (b) oxygen road map
 - (c) hydrogen road map
 - (d) hydrocarbon road map

C. Short answer questions

1. What is the purpose of having PUC?
2. List some tips for controlling pollution.



Introduction to Vehicle Maintenance and Servicing



17969CH06

INTRODUCTION

Automobiles need maintenance from time to time. Like humans are required to maintain hygiene, similarly automobiles also need to be kept clean. Automobiles have to run on dirty roads and in a polluted environment. They run on uneven roads with potholes and other obstructions, and are therefore subjected to loads which damage them. Therefore, there is a need for regular maintenance and servicing of automobiles, which is usually done in auto workshops or auto service stations.

In this Unit, you will understand the concept of vehicle maintenance and servicing.

SESSION 1: IMPORTANCE OF VEHICLE MAINTENANCE AND SERVICING

As you may be aware, there is an increase in the number of vehicles, such as motorcycle, scooter, bus, car, jeep, tempo, truck, tanker, etc., running in the cities.

Every new vehicle comes with a vehicle maintenance manual. The owner of the vehicle is expected to read and use this manual, as it mentions vehicle maintenance

tips during driving. It has been noticed that after getting a car or vehicle, the owners do not care much about a regular car or vehicle maintenance.

Even if the owners regularly service their vehicle, the vehicle maintenance tips given in the vehicle maintenance manual increases the longevity or life of the vehicle to a great extent.

Vehicle maintenance and servicing is carried out when the vehicle completes certain kilometres on its normal running or when the vehicle does not give proper performance. It is suggested that the vehicle owners carry out regular and periodical checks on their vehicle, some of which are mentioned below.

Daily Inspection (DI)

It is the responsibility of a driver or owner of a vehicle to carry out the following inspection and checks daily, before starting the engine, to avoid any type of breakdown on the road.

- (i) Check tyre pressure in all the tyres visually or by hitting the tyre wall with the help of a stone and judge the sound
- (ii) Check the radiator's coolant level
- (iii) Check the fan belts for looseness
- (iv) Check the level of engine oil
- (v) Check the windscreen, rear-view mirror and rear-window glass for their cleanliness

Maintenance Check-up

When one plans a long distance travel, it is necessary to carry out a routine check-up. One should read the vehicle maintenance manual for clarity. Some important check-ups are done for better maintenance (see Fig. 6.1).

- (i) Topping of oil level
- (ii) Proper tension of belt
- (iii) Battery for cleanliness and level of electrolyte (add only distilled water for topping of electrolyte water)
- (iv) Brakes
- (v) Topping up of coolant, if required, in the coolant reservoir

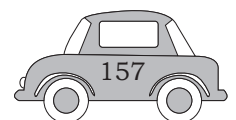

- (vi) Checking the serviceability of cooling system hoses
- (vii) Proper tyre inflation pressure
- (viii) Air conditioning



Fig. 6.1: Service centre

Vehicle maintenance is generally done at a vehicle service centre. You could make a visit to a nearby vehicle service centre to see how a vehicle is maintained and what all checks are carried out by service mechanic. Some important check-ups are discussed here.

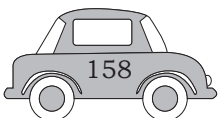

Fig.6.2: Checking oil levels

Some important check-ups are discussed here.

Check or Top-up All Vehicles' Oil Levels

Service mechanic, with the help of a measuring stick, checks the engine oil, coolant, brake oil and water. During routine check-up, oil, water and coolants are topped up or otherwise they are changed (Fig. 6.2).



Belt Check-up

Checking of belt is very important. If it is loose or broken, then it needs to be replaced immediately.

Battery

It is a very important component of a vehicle. It should be checked regularly. Battery electrolyte (distilled water) is checked by removing the battery caps and looking inside. If the level is low, it is topped up with distilled water. Nowadays, batteries are maintenance-free which means they have sealed caps and require no checking. But, some batteries though said to be maintenance-free, do have removable caps. These should be checked in the usual manner (Fig. 6.3).

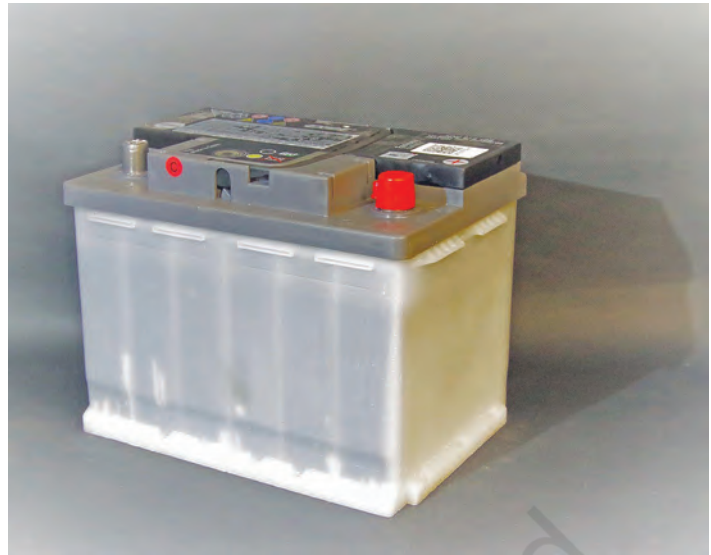

Fig. 6.3: Battery

Brakes

The service mechanic checks the brake by pushing the pedal. If there is need of servicing, the service mechanic informs the customer accordingly (Fig. 6.4).

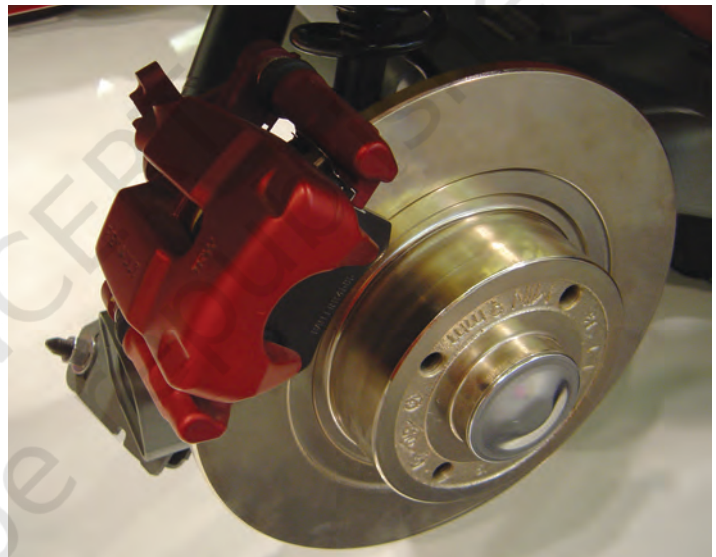

Fig. 6.4: Wheel brakes

Cooling System

The technician checks the cooling system by topping up the coolant. The cooling system should be refilled with the correct coolant, and not with water alone (Fig. 6.5).



Fig.6.5: Cooling system

Air Conditioning

The service mechanic checks cooling and heating by examining if the airflow is coming from all appropriate vents.



Fig. 6.6: Tyre

Tyres

The mechanic at the service station (see Fig. 6.7) examines the tyres by checking correct tyre pressure, and also checks whether there is any external damage (Fig. 6.6).

The safety rules to be followed during servicing of vehicle include:

- (i) Always select appropriate tools for a specific job. An inapt tool could damage the part being worked on and could cause one to get hurt
- (ii) Keep tools and equipment under control
- (iii) Wipe excess oil and grease off hands and tools so that one can get a good grip on tools or parts
- (iv) Work quietly and with full concentration
- (v) Keep jack handles out of the way. Stand the creeper against the wall when not in use
- (vi) Do not put sharp objects, such as screwdrivers, in one's pocket. One could cut oneself or get stabbed, or could damage the seat
- (vii) Make sure that the technician's clothes are right for the job and one wears full leather safety shoes
- (viii) If oil, grease, or any liquid spills on the floor, clean it up to avoid falls
- (ix) Always wear eye protection when using a grinding wheel or welding equipment, or while working with chemicals, such as solvents
- (x) While using a jack, place it properly to avoid slip
- (xi) Never run an engine in a closed garage or service station that does not have proper ventilation system. The exhaust gases contain carbon monoxide, a colourless, odourless, tasteless poisonous gas that can be toxic.

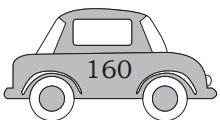



Fig. 6.7: Service station

Practical Exercise

Activity 1

List the steps carried out during the pre-checkup activity of a vehicle.

S. No.	Steps of Pre-checkup activity
1.	
2.	
3.	
4.	
5.	

Check Your Progress

A. Fill in the blanks

1. Vehicle maintenance and servicing is carried out when the vehicle completes _____ kilometres.
2. After overhauling, the vehicle regains its _____.
3. When you plan a long-distance travel, take some time to make sure that your _____ is ready to take you outside.

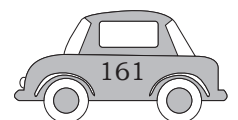

4. During pre-check-up, items like vital fluids, battery, _____, air conditioning, _____, belt, hoses and cooling system should be checked.

B. Multiple choice questions

1. Before starting the engine the driver or owner of the vehicle must inspect the _____.
 - (a) tyre pressure
 - (b) radiator coolant
 - (c) engine oil
 - (d) All of the above
2. The exhaust gases contain _____.
 - (a) carbon monoxide
 - (b) carbon oxide
 - (c) carbon dioxide
 - (d) hydrocarbon
3. If the battery electrolyte level is low it can be topped-up using _____.
 - (a) pure water
 - (b) distilled water
 - (c) sea water
 - (d) None of the above
4. Coolant is used in _____.
 - (a) engine oil
 - (b) brake oil
 - (c) cooling system
 - (d) battery

C. Short answer questions

1. List the safety rules to be followed during servicing of a vehicle.
2. Why is it important to employ the right tool for the right job?

SESSION 2: TIPS TO EXTEND THE LIFE OF A VEHICLE

Care and maintenance keep a vehicle running in good condition.

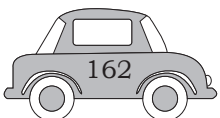

The following suggestions help in better maintenance of a vehicle, and must be observed in day-to-day life.

- (i) Drive the vehicle with care every day
- (ii) Be patient during the accident or breakdown of a vehicle, call helpline number of vehicle
- (iii) Buy petrol from reputed and trustworthy service stations
- (iv) Do not fill up fuel if your vehicle is parked around an oil tanker
- (v) Car keychain should be light
- (vi) Preserve the car during long-term storage
- (vii) Clean the inside too
- (viii) Clean dash gauges carefully
- (ix) Preserve door and window seals
- (x) Do not carry too much load
- (xi) Use upholstery cleaners on soiled seats
- (xii) Place a towel under baby seats
- (xiii) Protect car paint from the sun by parking it in a spot that is out of direct sunlight. You can also apply high-quality wax as it prevents sun damage to car paint from ultraviolet radiation
- (xiv) Maintain proper tire inflation
- (xv) Check for uneven wear
- (xvi) Rotate your tyres
- (xvii) Get wheel alignment checked
- (xviii) Top off brake fluid
- (xix) Care for anti-lock brakes
- (xx) Check engine oil at every other fill-up
- (xxi) Change oil frequently
- (xxii) Do not mix coolants
- (xxiii) Avoid hose hassles
- (xxiv) Check drive-belt tension
- (xxv) Clean your engine
- (xxvi) Keep the AC functional, even occasionally during winters
- (xxvii) Maintain your car's battery
- (xxviii) Seal a leaky radiator
- (xxix) Dilute your coolant

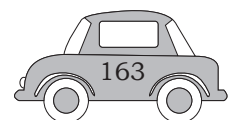

Practical Exercises

Activity 1

List some important safety tips of a vehicle.

S. No.	Tips
1.	
2.	
3.	
4.	
5.	

Check Your Progress

A. Fill in the blanks

1. Clean dash gauges _____.
2. It is important to maintain proper _____ inflation.

B. Multiple choice questions

1. During the breakdown of a vehicle we may call _____.
(a) police
(b) hospital
(c) helpline of service centre
(d) None of the above
2. Wax is used to protect the car's _____.
a) life
b) paint job
c) engine
d) battery

C. Short answer questions

1. Why is it necessary to service a vehicle?
2. List some tips for maintaining a tyre.

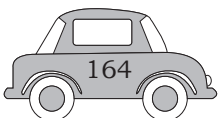

SESSION 3: INTRODUCTION TO VEHICLE SERVICE PROCEDURE

You may have noticed that authorised automobile service centres adopt certain procedures during the service of a vehicle. In this session, we will discuss the common activities done in the service centre. One of the most important part is job card and its filling procedure.

Common Activities in the Workshop

- (i) Job card and its filling procedure
- (ii) Washing of vehicle and Washing Procedure
- (iii) Engine minor tune up
- (iv) Oil replacement
- (v) Checking of battery—electrolyte level and top-up
- (vi) Clutch and brake-free play and their adjustment
- (vii) Lighting system, its various parts and their checking
- (viii) Identification of greasing points of wheelers and procedure of greasing
- (ix) Checking of tyre inflation and procedure of inflation

Job Card and Its Filling Procedure

When a vehicle owner enters the service centre, he or she is attended by the supervising engineer. The customer informs about the vehicle defect. After getting feedback from the vehicle owner or driver regarding defects of the vehicle, the supervising engineer in a service station or workshop inspects it. The defects pointed out or listed are noted down in a standard format, which is called the job card or work order.

In order to indicate his satisfaction with the diagnosis made by the supervising engineer, the customer of the vehicle signs the job card before the repairs on the vehicle are started. Work is then assigned to the concerned person to carry out repairs and the supervisor signs the job card too. The work order or job card is prepared in duplicate.

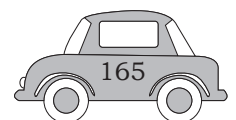

Contents of a Standard Job Card

- (i) Job card number
- (ii) Name, address and phone number of the service centre
- (iii) Name, address and phone number of the customer
- (iv) Details of vehicle, such as make, model, registration number, chassis number, engine number, date of sale, kilometres' reading, receiving date and time, delivery date and time by the service centre
- (v) Checklist before trial
- (vi) Customer's observation
- (vii) Job to be done
- (viii) Estimated cost in rupees for the customer and insurance company
- (ix) Labour required
- (x) Name of the mechanic
- (xi) Name and signature of the supervisor
- (xii) Customer's authorisation for repair and their signature
- (xiii) Acknowledgement

Filling the Job Card

Almost all the information must be properly filled in the job card (Fig. 6.8) by the supervisor with their signature and the customer also needs to sign on the authorisation for work column. Then the repairing or servicing job on the vehicle is taken over.

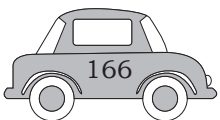

A standard job card is shown below. The student must practise to fill the same.



JOB CARD NO. 14050



<p>SETCO 09/2-A, Industrial Area, Nazafgarh Road, Near Hans Motors, Behind Moti Nagar Bus stand, New Delhi-110 018 Tel. : 011-64644400, 9268564445 Branch 1 : 847/2, Main Mata Chowk, Vasant Vihar Road, Mahipalpur, New Delhi-110 037 Tel. : 011-64644401, 9268573335 Branch 2 : C-240, Near Radha Krishna Mandir, Pandav Nagar, Delhi-110 092 Tel. : 011-22483501, 9268573337 E-mail : services@setco.biz</p>	Name : Address : Phone : Res. : Office : Mobile :	Model : Regn. No. : Chassis No. : Engine No. : Date of Sale : Kms. Reading : Receiving Date & Time : Delivery Date & Time :			
Free Service No. <input type="text"/> Protection Plus <input type="checkbox"/> Paid <input type="checkbox"/> Warranty <input type="checkbox"/> FOC <input type="checkbox"/> Accidental <input type="checkbox"/> Complain <input type="checkbox"/> Coupon No. <input type="text"/>					
CHECK LIST	OK	Not OK	Customer's Observation	Job to be Done	Estimated Cost Rs.
Check Before Trial Engine : Idle RPM <input type="checkbox"/> <input type="checkbox"/> Engine Oil Qty. <input type="checkbox"/> <input type="checkbox"/> Electrical : Battery <input type="checkbox"/> <input type="checkbox"/> Horn <input type="checkbox"/> <input type="checkbox"/> Type Pressure : Front / Rear PSI <input type="checkbox"/> <input type="checkbox"/> <input type="checkbox"/> <input type="checkbox"/> Clutch Lever Free Play <input type="checkbox"/> <input type="checkbox"/> Brake Lever Free Play <input type="checkbox"/> <input type="checkbox"/> Brake Pedal Free Play <input type="checkbox"/> <input type="checkbox"/> Damage & Shortages-Yes No Lights (HL/TL/BL/Win/Pilot) Rear View Mirror (L/R) Dent (D) / Scratches (s) : Choke Cap : Yes/No Tool Kit : Yes/No Accessories : Fuel Level  Others (if any) :					
Note : 1) Please advice Customer on "Not OK" points. 2) Please verify Customer Observation.				LABOUR	
				TOTAL	
Mechanic Name :			Supervisor's Sign :		
CUSTOMER AUTHORIZATION					
I hereby Authorise the above jobs to be done & parts, if required it will be at my cost. Any additional jobs or parts required shall be at my cost. Vehicle is stored, repaired, tested and driven at my risk. Estimate given above for the labour charges and parts is only approximate.					
Customer Signature				Date :	
Job Card No. <p>SETCO 09/2-A, Industrial Area, Behind Moti Nagar Bus Stand Tel. : 011-64644400, 9268564445 Branch 1 : 847/2, Mahipalpur, Tel. : 011-64644401, 9268573335 Branch 2 : C-240, Pandav Nagar Tel. : 011-22483501, 9268573337 E-mail : services@setco.biz</p>	Acknowledgment			Date	
	Regn. No. :		Chassis No.		
	Receiving Date		Delivery Date/Time		
	Model :			Supervisor's Signature	

Fig. 6.8: Job card sample



Practical Exercises

Activity 1

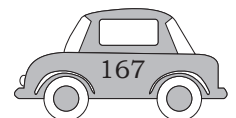
List some important service procedures of a vehicle.

S. No.	Vehicle service procedure
1.	
2.	
3.	
4.	
5.	

Check Your Progress

A. Fill in the blank

1. Job card is used for filling _____ of a vehicle.

B. Multiple choice questions

1. Defects pointed out are noted down in a standard format which is known as _____.
 - (a) complaint book
 - (b) rule book
 - (c) job card
 - (d) register
2. What type of vehicle information is required to be mentioned in a job card?
 - (a) Chassis No.
 - (b) Engine No.
 - (c) Model No.
 - (d) All of the above
3. The acknowledgement form must have the signature of the _____.
 - (a) supervising engineer
 - (b) mechanic
 - (c) owner of service centre
 - (d) None of the above

C. Short answer questions

1. What is a job card?
2. What all is done during the service of a vehicle?

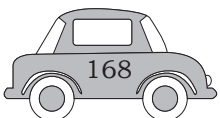

AUTOMOTIVE SERVICE TECHNICIAN - CLASS 9

UNIT 6 : INTRODUCTION TO VEHICLE MAINTENANCE AND SERVICING

SESSION 1: IMPORTANCE OF VEHICLE MAINTENANCE AND SERVICING

Check Your Progress

A. Fill in the blanks

1. Vehicle maintenance and servicing is carried out when the vehicle completes _____ kilometres.
2. After overhauling, the vehicle regains its _____.
3. When you plan a long-distance travel, take some time to make sure that your _____ is ready to take you outside.
4. During pre-check-up, items like vital fluids, battery, _____, air conditioning, _____, belt, hoses and cooling system should be checked.

B. Multiple choice questions

1. Before starting the engine the driver or owner of the vehicle must inspect the _____.
 - (a) tyre pressure
 - (b) radiator coolant
 - (c) engine oil
 - (d) All of the above
2. The exhaust gases contain _____.
 - (a) carbon monoxide
 - (b) carbon oxide
 - (c) carbon dioxide
 - (d) hydrocarbon
3. If the battery electrolyte level is low it can be topped-up using _____.
 - (a) pure water
 - (b) distilled water
 - (c) sea water
 - (d) None of the above
4. Coolant is used in _____.
 - (a) engine oil
 - (b) brake oil
 - (c) cooling system
 - (d) battery

C. Short answer questions

1. List the safety rules to be followed during servicing of a vehicle.
2. Why is it important to employ the right tool for the right job?

SESSION 2: TIPS TO EXTEND THE LIFE OF A VEHICLE

Check Your Progress

A. Fill in the blanks

1. Clean dash gauges _____.
2. It is important to maintain proper _____ inflation.

B. Multiple choice questions

1. During the breakdown of a vehicle we may call _____.
 - (a) police
 - (b) hospital
 - (c) helpline of service centre
 - (d) None of the above
2. Wax is used to protect the car's _____.
 - a) life
 - b) paint job
 - c) engine
 - d) battery

C. Short answer questions

1. Why is it necessary to service a vehicle?
2. List some tips for maintaining a tyre.

SESSION 3: INTRODUCTION TO VEHICLE SERVICE PROCEDURE

Check Your Progress

A. Fill in the blank

1. Job card is used for filling _____ of a vehicle.

B. Multiple choice questions

1. Defects pointed out are noted down in a standard format which is known as _____.
 - (a) complaint book
 - (b) rule book
 - (c) job card
 - (d) register
2. What type of vehicle information is required to be mentioned in a job card?
 - (a) Chassis No.
 - (b) Engine No.
 - (c) Model No.
 - (d) All of the above
3. The acknowledgement form must have the signature of the _____.
 - (a) supervising engineer
 - (b) mechanic
 - (c) owner of service centre
 - (d) None of the above

C. Short answer questions

1. What is a job card?
2. What all is done during the service of a vehicle?



Innovation and Development in Automobiles

INTRODUCTION

Innovation leads to development of new technologies, with which the customers get benefits in terms of comfort and safety. Sometimes, innovation also helps in lowering the cost of the product. The automobile sector is witnessing a lot of development in terms of innovations, as a result of which new automobile models are being launched in the market.

Innovation has also been noticed in the field of passenger safety. A number of devices, such as air bags, are now provided in cars so that in case of an accident, the passengers can be saved. There is a lot of research going on in the area of alternative fuels due to economic reasons and environmental concerns. Even solar energy based cars have been designed these days, which can run up to 80 kms in a day. Some cars have been designed which use electrical energy. A combination of electrical and petrol energy has been used in cars, which are called 'hybrid' cars. Technological developments of design and innovation and chassis have led to the development of MPFI (Multi Point Fuel Injection) system which gives more mileage per litre of fuel.



I 7969CH07

Nowadays, innovation has become more predictable. It is a detailed method for achieving objectives of better designs, lower costs, different fuels, etc. In major auto companies of the world, there are large teams working on new developments and innovations. It is a continuous process involving lots of experimentation by highly qualified engineers and scientists. In this Unit, you will understand the new innovations and developments taking place these days.

SESSION 1: INNOVATION AND DEVELOPMENT

You may have seen some old cars running on roads in your village, town or city. Some old models like Ambassador cars can still be seen but their number is reducing day by day. You would have also noticed more stylish cars on the roads nowadays. Same is the case with scooters and motorcycles. Even buses and trucks look different today. Can you name a famous car innovation by an Indian company a few years ago? It was the Tata Nano car manufactured by Tata Motors. It is one of the smallest as well as lowest-powered cars in the world. It was designed to be the cheapest car in India aimed mainly at the lowest price segment in the country (Fig. 7.1).



Fig. 7.1: Tata Nano

Apart from looks and style, one important challenge among car manufacturers is the use of alternate fuel, as both petrol and diesel are a limited resource. A lot of research has been done in this field, and some companies are even working on a project to run vehicles on water or air only!

Some of the technologies being incorporated into new automobile designs include gas-electric hybrids, fuel cells and biomass fuel sources including methane.

Electric Car

An electric car is an automobile that is propelled by one or more electric motors, using electrical energy stored in

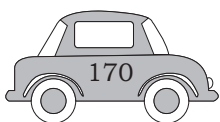

batteries or another energy storage device. Electric cars are pollution free and have zero tail pipe emission. Such a car helps in reducing urban air pollution. Electric cars are generally more expensive than petrol, the primary reason being the high cost of car batteries (Fig. 7.2).

Hybrid Vehicle

It is a vehicle that uses two or more distinct power sources to move the vehicle. A hybrid vehicle is also known as Hybrid Electric Vehicle (HEV). This vehicle combines an internal combustion engine and electric motor. Although electric cars have been around since the inception of the automobile, a new breed of gas-electric hybrid autos were introduced in the United States of America several years ago. Most of the major automobile manufacturers including General Motors, Honda, Toyota, Ford and Diamler-Chrysler have either introduced or are planning to introduce new hybrid models during the next several years. New car sales on hybrids have increased by approximately 36 per cent in the U.S. Fig. 7.3 shows Toyota Prius which is the world’s top selling hybrid car, with a cumulative global sales of 2.5 million units by February 2016.



Fig. 7.2: Electric car



Fig. 7.3: Hybrid vehicle

Fuel Cells

Automobile fuel cell technology is under development and has not been marketed yet. However, this innovative energy technology has the potential to revolutionise transportation. Fuel cell car technology under development creates electricity through a chemical reaction between hydrogen and oxygen (air). The reaction creates heat which is stored in batteries to power the car. The reaction creates only water and heat and may offer a solution to our energy and environmental situations (Fig. 7.4).

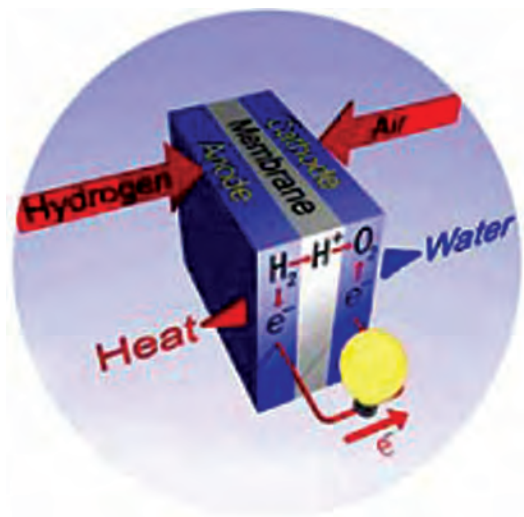

Fig. 7.4: Fuel cells

General Motors introduced a fuel cell stack that is 60 per cent more powerful than any competitor, and has launched a fuel cell car called HydroGen3 to the public.

Biomass Fuel



Fig. 7.5: Biomass fuel

Biomass automotive fuels and lubricants have been gaining acceptance over the past several years, primarily as a result of environmental concerns. Biomass fuels are typically generated through the decay of organic matter. For the past several years, ethanol and di-methyl ether produced from biomass have been added to oxygenate fuels and reduce emissions. Biomass

fuel can also produce hydrogen which can be used in fuel cell vehicles. Methane created from biomass is also being explored as a transportation fuel alternative (Fig. 7.5).

Biofuel

Have you heard about the jatropha plant? The jatropha plant seeds are very rich in oil (40 per cent). Jatropha oil has been used in India for several decades as biodiesel for the diesel fuel requirements of remote rural and forest communities. Jatropha oil can be used directly after extraction (i.e., without refining) in diesel generators and engines.

The former President of India, Dr Abdul Kalam strongly advocated jatropha cultivation for production of biodiesel. In our country, out of the 6,00,000 km² of wasteland that is available in India over 3,00,000 km² is suitable for jatropha cultivation. Once this plant is grown, the plant has a useful lifespan of several decades. During its life, jatropha requires very little water when compared to other cash crops. Jatropha oil is being blended with diesel and used in Indian vehicles.

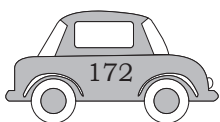

New Developments

Car Technology: The Latest Innovations in Engine Development and Safety

Car technology is focussing increasingly on safety, efficiency and the environment. Some of the major innovations are given below.

(a) Engine development

Carbon emissions have become an issue of contention for new and used car owners. Motorists are being encouraged by both politicians and the media to downsize their vehicles and reduce their carbon footprint. Many manufacturers have changed their engine and reduced carbon dioxide emissions—tail piece emission. BMW, Mini Cooper Diesel, Mercedes, Mercedes Benz and many more have adopted new technologies in there engine.

(b) Convenience and safety

- (i) *Automatic parking*: The wheel scuffer's dream will soon be possible in a whole range of luxury cars. One will have to simply drive along a row of parked cars and the system would detect a space big enough for the vehicle to squeeze into. No intervention would be required from the driver's end. The driver could even take their hands and feet off everything, and watch in astonishment as the car parks itself.
- (ii) *Pre-scan technology*: This technology was also showcased in the Mercedes F700 concept, where lasers scan the road surface before the car drives over it. This prepares the suspension to react to the terrain accordingly and ensures peerless ride comfort.
- (iii) *Saab Alcokey*: Saab helps reduce the number of alcohol-related road incidents with this device by fitting it as standard—apparently, one in three traffic accidents in Europe are alcohol-related. This fully integrated system requests the driver to blow into a wireless handheld unit before driving the car. The breath is then analysed and if the blood-alcohol limit is exceeded, a red LED appears and the engine does not start.

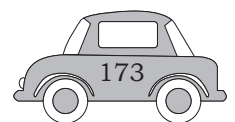

- (iv) *Volvo sleep detection:* Volvo has introduced both Driver Alert Control (DAC) as well as a Lane Departure Warning (LDW) system as a £500 option on some of its higher-priced models. LDW uses cameras located between the windscreen and the rear-view mirror and monitors the car's position between the road markings. Only after a certain speed is reached does the system become active. If the car then wanders across any lane markings without using an indicator, the driver is audibly alerted.
- (v) *Collision warning system:* Swedish car maker Volvo is also developing a collision warning system which uses radar technology with a wide-angle search area to detect objects in front of and around the car. If the car approaches a pedestrian, a red warning light comes on the windscreen's head-up display and a warning signal sounds. This helps the driver to react and, in most cases, avoid an accident. If the risk of a collision increases, assisted panic braking is activated to provide more pressure when the brakes are applied, but if the driver still doesn't apply brake and a collision is imminent, the car's brakes are activated automatically.

This system can even be expanded to incorporate collision avoidance programming, where the car could actually perform a direct input to the steering wheel and to the direction of travel if an imminent crash is detected.

- (vi) *Vehicle to vehicle technology:* This hi-tech system is being developed by General Motors and uses wireless technology to allow a driver in one car to receive information from another car further ahead on the same road—suppose the other driver has come across an obstacle or has slammed on the brakes. This system allows the other driver to receive this information in sufficient time to react and therefore avoid any accident.

- (vii) *Driverless cars:* These 'intelligent vehicles' are capable of taking a person from one point to another without any driver. Providing a 'taxi-like' experience to the passengers, these vehicles would navigate the roads on their own. Also called as autopilot, autonomous

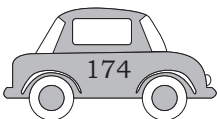

vehicle or auto-drive car. An example of such smart cars is the 2getthere passenger vehicle based on the FROG navigation technology that originated in The Netherlands, DARPA Grand Challenge (from USA) and AGRO research project (from Italy).

- (viii) *Emission standards*: With the help of automotive technologies, a check can be put on the emission of harmful pollutants, such as NO₂, particulate matter (PM) or soot, carbon monoxide (CO) or volatile hydrocarbons. As a result, it would reduce the pollution level and save the planet from global warming.
- (ix) *Suspension technology*: The suspension system comprises springs, shock absorbers and linkages. This system connects the vehicle to its wheels. The main function of a suspension system is to minimise jerks and provide comfort to the occupants of the vehicle. With the advancement of technology, gas-filled shock absorbers have been developed which are much more responsive than the spring absorbers.

Apart from the above-mentioned technologies, steering technology and safety technologies have also helped the automotive industry in a big way to reach great heights.

Innovative Car Safety Technologies in New Honda City

Car safety technologies have gained prominence in recent years with the growing number of road accidents. Modern-day cars are well equipped with safety devices compared to the older ones. The New Honda City recently launched by Honda Seil Cars India in the Indian car market is a perfect example of safety.

Trinity of Braking System

Trinity of braking system is one of the most significant safety systems in the new Honda City. The trinity comprises the Anti-lock Braking (ABS), Electronic Brakeforce Distribution (EBD) and Brake Assist. The combination of these advanced safety technologies sets a new standard in car safety feature.

ABS uses a system of sensors, an electronic control unit and a hydraulic control unit. All these work in

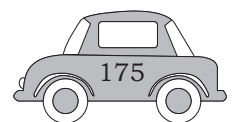

association with each other to monitor the movement of car wheels and prevent wheel lock up. When any of the car wheels is about to lock while braking, the sensors sense the situation and the electronic unit or the ABS computer sends the signal to the hydraulic unit. After receiving the signal, the system modulates the braking pressure of the corresponding wheel and prevents lock up. The key motive of the ABS system is to help car drivers maintain steering control during hard braking, especially in case of slippery road conditions.

The introduction of EBD with the ABS, holds its own significance in improving safety standards. The system works in conjunction with the anti-lock brakes to electronically distribute the braking pressure between front and rear wheels. It optimises the braking performance by maintaining the pressure balance between both front and rear wheels based on road conditions, car weight, car speed and the available traction. This balance is very important as the car would otherwise spin if the rear wheels lock up before the front wheels.

The Brake Assist system also plays a key role in ensuring faster and safer braking in association with the other two members of the trinity. This system monitors the use of brake pedal and automatically senses the need to stop the car in case of an approaching accident or as a result of panic.

G-Force Control Technology (G-CON)

G-CON or the G-force control technology is one of Honda's best innovations designed in response to the need to control or absorb the crash force in event of an unavoidable accident.

This technology helps to reduce the impact of collision from all directions on the car body. The all-new Honda City is designed with the same impact absorbing body structure along with a strong survival zone to cocoon its passengers in case of an accident. It is believed that the car is estimated to withstand a fixed-barrier frontal collision at around 55 km/hr, a side collision at around 50 km/hr, and a rear impact at around 50 km/hr.

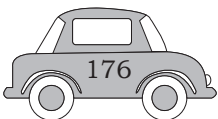

Pedestrian Safety

Honda's commitment to safety also includes the safety of common people who walk on roads. Safety of pedestrians has always been a key concern for Honda. With this concern, the company first studied the dynamics of pedestrian collision according to which when a person is stuck by an oncoming car, they are thrown up onto the car hood before rolling on the street. Keeping this in mind, the company introduced pedestrian safety dummies known as POLAR II.

POLAR II is believed to be the most advanced test dummy that was designed with realistic human structure along with sensors to measure the impact of energy on a human body during a car accident. Data received after crash testing these dummies has been used to re-evaluate the shape and design of the vehicles.

The New Honda City is also designed in accordance to the data received after conducting a crash test with the POLAR II. In the event of an accident with the new Honda City, the bonnet and front wings of the car deform on contact with a pedestrian. Even the hinges on the car bonnet and wiper pivots are designed in such a way that they bend, break or absorb energy so that head injuries to the pedestrian can be minimised. These developments are continuous and helpful to the passenger.

Practical Exercises

Activity 1

List the types of innovation that have come up in the automobile sector.

S. No.	Name of innovation
1.	
2.	
3.	
4.	

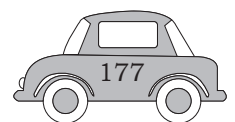

Check Your Progress

A. Fill in the blanks

1. A hybrid vehicle is a vehicle that uses two or more distinct _____ sources to move the vehicle
2. Biomass fuels are typically generated through the _____ of organic matter.
3. Old technology vehicles are outdated because they are more _____.
4. G-CON technology helps to reduce the impact of collision from _____ directions on the car body.

B. Multiple choice questions

1. Up to how many kms can solar energy-based cars travel in a day?
(a) 80 km (b) 30 km
(c) 40 km (d) 60 km
2. The vehicle which combines an internal combustion engine and electric motors is a _____.
(a) hybrid vehicle
(b) electric car
(c) fuel cells car
(d) biomass fuel car
3. The full form of ABS is _____.
(a) Anti-lock Bike System
(b) Anti-brake System
(c) Anti-lock Braking System
(d) None of the above
4. Which of these personalities was a former President of India and a strong advocator of jatropha cultivation for production of biodiesel?
(a) Mrs Pratibha Devi Patil
(b) Dr K R Naraynan
(c) Dr Abdul Kalam
(d) Mr Pranab Mukherjee

C. Short answer questions

1. What is a hybrid vehicle?
2. What is the use of ABS?

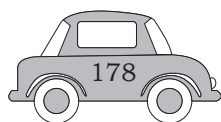

AUTOMOTIVE SERVICE TECHNICIAN - CLASS 9

UNIT 7 : INNOVATION AND DEVELOPMENT IN AUTOMOBILES

SESSION 1: INNOVATION AND DEVELOPMENT

Check Your Progress

A. Fill in the blanks

1. A hybrid vehicle is a vehicle that uses two or more distinct _____ sources to move the vehicle
2. Biomass fuels are typically generated through the _____ of organic matter.
3. Old technology vehicles are outdated because they are more _____.
4. G-CON technology helps to reduce the impact of collision from _____ directions on the car body.

B. Multiple choice questions

1. Up to how many kms can solar energy-based cars travel in a day?
(a) 80 km (b) 30 km
(c) 40 km (d) 60 km
2. The vehicle which combines an internal combustion engine and electric motors is a _____.
(a) hybrid vehicle
(b) electric car
(c) fuel cells car
(d) biomass fuel car
3. The full form of ABS is _____.
(a) Anti-lock Bike System
(b) Anti-brake System
(c) Anti-lock Braking System
(d) None of the above
4. Which of these personalities was a former President of India and a strong advocator of jatropha cultivation for production of biodiesel?
(a) Mrs Pratibha Devi Patil
(b) Dr K R Naraynan
(c) Dr Abdul Kalam
(d) Mr Pranab Mukherjee

C. Short answer questions

1. What is a hybrid vehicle?
2. What is the use of ABS?

Answer Key

Unit 1: History and Evolution of Automobiles

Session 1: Invention of Wheel

A. Fill in the blanks

1. Wheel
2. Mesopotamia, 5500
3. circular
4. device, object
5. lower

B. Multiple choice questions

1. c
2. a
3. c

Session 2: Wheel Cart

A. Fill in the blanks

1. animal
2. horses
3. two-wheeled vehicle
4. 10-12

Session 3: Invention of Automobiles

A. Fill in the blanks

1. 1672
2. internal combustion engine
3. Karl Benz
4. Beetle

B. Multiple choice questions

1. a
2. a
3. a

Session 4: Invention of Automobiles (Post World War II)

A. Fill in the blanks

1. Mustang
2. American
3. 1920
4. Ambassador, Fiat
5. Suzuki
6. Nano

B. Multiple choice questions

1. a
2. a
3. c
4. b

Unit 2: Various Types of Automobiles

Session 1: Two-wheelers and Three-wheelers

A. Fill in the blanks

1. vehicle
2. Two-wheeler
3. three wheels, tri-motorcycle
4. common, transportation

B. Multiple choice questions

1. a
2. b
3. a
4. d

Session 2: Passenger Vehicles and Commercial Vehicles

A. Fill in the blanks

1. four
2. goods, material
3. Willys Overlands
4. transporting goods and passenger

Session 3: Agricultural Vehicles

A. Fill in the blanks

1. implement
2. power, mechanise
3. harvesting, threshing
3. labour saving

Session 4: Construction Equipment Vehicles

A. Fill in the blanks

1. compactor, concrete, construction
2. bulk material
3. heavy machine
4. excavating the soil
5. 10 tonnes

B. Multiple choice questions

1. a 2. b 3. c 4. b

Session 5: Special Vehicles

A. Fill in the blanks

1. engine 2. diesel or electricity 3. lifting
4. longer, tankers 5. liquids

B. Multiple choice questions

1. a 2. d 3. d 4. a

Unit 3: Major Systems and Components of an Automobile

Session 1: Chassis and Auto Body

A. Fill in the blanks

1. vehicle 2. vehicle 3. steel 4. part 5. tank

B. Multiple choice questions

1. a 2. d 3. a 4. a 5. C

Session 2: Engine and Its Components

A. Fill in the blanks

1. heart 2. mechanical
3. crankshaft, connecting rod, piston, cylinder
4. air-fuel, petrol engine 5. ignite the mixture

B. Multiple choice questions

1. a 2. a 3. a 4. a

Session 3: Lubrication System

A. Fill in the blanks

1. two metallic surfaces 2. heat
3. friction 4. cushioning, cooling

B. Multiple choice questions

1. c 2. a 3. d 4. b

Session 4: Cooling System

A. Fill in the blanks

1. heat 2. maintains 3. temperature 4. IC

B. Multiple choice questions

1. b 2. a 3. a

Session 5: Fuel Supply System

A. Fill in the blanks

1. mixed 2. IC 3. mix 4. ECM

B. Multiple choice questions

1. d 2. c 3. d 4. d

Session 6: Transmission System

A. Fill in the blanks

1. three 2. driving members, driven members, operating members
3. transmission system 4. clutch disc

B. Multiple choice questions

1. a 2. a 3. c 4. c

Session 7: Front and Rear Axle

A. Fill in the blanks

1. power 2. power transmission 3. outer wheel 4. bears

B. Multiple choice questions

1. a 2. a 3. b 4. a 5. a

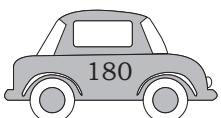

Session 8: Steering and Suspension System

A. Fill in the blanks

- controlling the vehicle
- steering wheel
- shock absorbers
- safe

B. Multiple choice questions

- b
- d
- d
- a

Session 9: Wheel, Tyre and Brake

A. Fill in the blanks

- vehicle
- rim
- equally well
- emergency

B. Multiple choice questions

- a
- c
- a

Session 10: Electrical or Electronic and Air Conditioning Systems

A. Fill in the blanks

- Evaporator
- charging
- motor
- heater

B. Multiple choice questions

- d
- a
- d
- a

Session 11: Active and Passive Safety

A. Fill in the blanks

- safety
- safety
- automatically
- accidents

B. Multiple choice questions

- d
- a
- a
- a

Unit 4: Road Safety

Session 1: Importance of Road safety

A. Fill in the blanks

- safety
- public health
- Concern
- driving
- ignored

B. Multiple choice questions

- a
- c
- b
- a

Session 2: Safe and Responsible Driving

A. Fill in the blanks

- four-wheelers
- stability
- good
- driver
- features

B. Multiple choice questions

- a
- c
- b

Session 3: Road Signs

A. Fill in the blanks

- smooth
- signal
- red, green, yellow

B. Multiple choice questions

- a
- a
- b

Session 4: Driving Rules and Registration

A. Fill in the blanks

- Form 20
- Road Transport
- vehicles

B. Multiple choice questions

- a
- d
- b
- a

Session 5: Driving Licence

A. Fill in the blanks

- theory
- vehicle
- Road transport
- vehicle
- 16 years

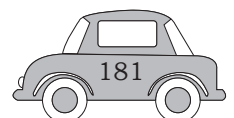

B. Multiple choice questions

1. a 2. a 3. a

Unit 5: Automobile and Environment

Session 1: Air Pollution

A. Fill in the blanks

1. degradation, depletion
2. Environment (Protection), environment
3. respiratory 4. Compressed Natural Gas
5. Source 6. 350 and 150

B. Multiple choice questions

1. a 2. a 3. d 4. b

Session 2: Auto Emissions and EU/BS Standards

A. Fill in the blanks

1. engine 2. combustion 3. 1991
4. 85% and 61% 5. NCR, Mumbai, Delhi, Kolkata

B. Multiple choice questions

1. a 2. d 3. a

Session 3: PUC Certification

A. Fill in the blanks

1. CNG 2. Pollution Under Control 3. PUC centre
4. Compressed Natural Gas 5. weak

B. Multiple choice questions

1. c 2. c

Unit 6: Introduction to Vehicle Maintenance and Servicing

Session 1: Importance of Vehicle Maintenance and Servicing

A. Fill in the blanks

1. the specified (by the vehicle's company)
2. strength 3. vehicle 4. air light

B. Multiple choice questions

1. d 2. a 3. b 4. c

Session 2: Tips to Extend the Life of a Vehicle

A. Fill in the blanks

1. regularly 2. tyre

B. Multiple choice questions

1. c 2. b

Session 3: Introduction to Vehicle Service Procedure

A. Fill in the blank

1. details

B. Multiple choice questions

1. c 2. d 3. a

Unit 7: Innovation and Development in Automobiles

Session 1: Innovation and Development

A. Fill in the blanks

1. power 2. decay 3. expensive 4. All

B. Multiple choice questions

1. a 2. a 3. c 4. c

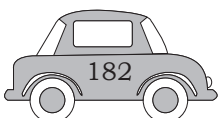

Glossary

Automised: *in this process, fuel is forced through a small jet opening under extremely high pressure to break it into a fine misted spray. From here, the mist is mixed with air (emulsified) and then vapourised into a rarefied form appropriate for use by an internal combustion engine.*

Bronze Age: *it is the time period when people made tools from an alloy (a mixture of metals) called bronze. Bronze is a yellowish-brown metal which is a mixture of copper and tin.*

Bullock-cart: *a bullock cart or ox cart is a two-wheeled or four-wheeled vehicle pulled by oxen (draught cattle). It is a means of transportation used since ancient times in many parts of the world.*

Catalytic converters: *it is an emission control system used to reduce the discharge of noxious and polluting gases from the internal-combustion engine.*

Chalcolithic: *a period in the 4th and 3rd millennia BC, chiefly in the near East and south-eastern Europe*

Designed water jacket: *a cooling water jacket is used for an engine and it is demonstrated that improvement of the water jacket passage is an effective method for enhancing its cooling capacity.*

Draught animal: *is a strong working animal used to draw loads like cart, plow etc., as opposed to a mount.*

External combustion engine: *an external combustion engine (EC engine) is a heat engine where a working fluid, contained internally, is heated by combustion in an external source, through the engine wall or a heat exchanger.*

Flash point: *the flash point of a chemical is the lowest temperature where it will evaporate enough fluid to form a combustible concentration of gas. The flash point is an indication of how easy a chemical may burn.*

Hybrid electric vehicles: *it is a type of vehicle that uses more than one means of power like diesel or petrol engine with an electric motor.*

Hydraulic suspension: *air suspension kits convert a vehicle's original suspension into an air suspension. These kits include air springs, mounts and fittings. An air suspension system works similar to hydraulics. However, air suspension systems use air springs and air to operate.*

Impact sensors: *a shock detector or impact monitor is a device which indicates a physical shock. A related use of an impact detector is as automobile air bag sensor. These sophisticated sensors are used to trigger the protective air bag system.*

Internal combustion engine: an internal combustion engine (ICE) is a heat engine where the combustion of a fuel occurs with an oxidizer (usually air) in a combustion chamber that is an integral part of the working fluid flow circuit.

Locomotive: a self-propelled vehicle that runs on rails and is used for moving railroad cars.

Quadricycle: it refers to vehicles with four wheels. In 1896 Ford called its vehicle the 'Quadricycle'; it ran on four bicycle tires with an engine driving the back wheels.

Neolithic: the word "Neolithic" comes from two words in Greek meaning 'new' and 'lithic', meaning stone. The Neolithic period is the time when farming was invented and when people started caring for animals, such as cows, sheep and pigs.

Quadricycle: it refers to vehicles with four wheels. In 1896 Ford called its vehicle the 'Quadricycle'; it ran on four bicycle tires with an engine driving the back wheels.

Spark plug: a spark plug is a device for delivering electric current from an ignition system to the combustion.

Specific gravity: it is the ratio of the density of a substance to the density of a reference substance; equivalently, it is the ratio of the mass of a substance to the mass of a reference substance for the same given volume.

Stub Axle: a short axle that carries one of the front steered wheels of a motor vehicle and is capable of limited angular movement about a king pin bevel pinion, bevel gear, cage of sun gear and star pinions, axle shafts and different support bearings

Suspension system: a system consisting of small particles kept dispersed by agitation (mechanical suspension) or by the molecular motion in the surrounding medium (colloidal suspension).

SUV: sports-utility vehicle or SUV is a kind of station wagon or estate car with off-road vehicle features like raised ground clearance and ruggedness and available four-wheel drive.

Thermal conductivity: it (often denoted k , λ , or κ) is the property of a material to conduct heat. It is evaluated primarily in terms of the Fouriers Law for heat conduction. Heat transfer occurs at a lower rate in materials of low thermal conductivity than in materials of high thermal conductivity.

Tillage: it is the agricultural preparation of soil by mechanical agitation of various types, such as digging, stirring and overturning.

Torque: the tendency of a force applied to an object to make it rotate about an axis. For a force applied at a single point, the magnitude of the torque is equal to the magnitude of the force multiplied by the distance from its point of application to an axis of rotation

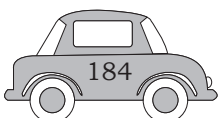

Wankle engine: *it is a type of internal combustion engine using an eccentric rotary design to convert pressure into rotating motion.*

Yoke: *it is a wooden beam normally used between a pair of oxen or other animals to enable them to pull together on a load when working in pairs, as oxen usually do; some yokes are fitted to individual animals.*

© NCERT
not to be republished

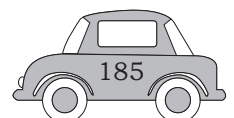

List of Credits

Unit 1

- Fig. 1.2 <https://goo.gl/zp3zbL>
Fig. 1.6 <https://goo.gl/78tWvN>
Fig. 1.7 <https://goo.gl/UhL2yq>
Fig. 1.8 <https://goo.gl/uKAUa9>
Fig. 1.9 <https://goo.gl/Rg7ym8>
Fig. 1.10 <https://goo.gl/YDn2px>
Fig. 1.11 <https://goo.gl/vz1ujU>
Fig. 1.12 <https://goo.gl/d4wY2X>
Fig. 1.13 <https://goo.gl/SLjqtg>

Unit 2

- Fig. 2.17 <https://goo.gl/joHYeF>
Fig.2.18: <https://goo.gl/Eu2MGK>
Fig.2.12 <http://goo.gl/SEGxpQ>
Fig.2.14 <https://goo.gl/F2kCM6>
Fig.2.15 <https://pxhere.com/en/photo/740337>

Unit 3

- Fig. 3.1 <https://goo.gl/x7eP4z>