

# Microirrigation Technician

(Job Role)

Qualification Pack: Ref. Id. AGR/Q1002

Sector: Agriculture

Textbook for Class XI



विद्यया ऽ मृतमश्नुते



एन सी ई आर टी  
NCERT

राष्ट्रीय शैक्षिक अनुसंधान और प्रशिक्षण परिषद्  
NATIONAL COUNCIL OF EDUCATIONAL RESEARCH AND TRAINING

ISBN 978-93-5292-146-1

**First Edition**

June 2019 *Jyeshtha 1941*

**PD 5T SU**

© **National Council of  
Educational Research and  
Training, 2019**

₹ **110.00**

*Printed on 80 GSM paper with  
NCERT watermark*

Published at the Publication Division  
by the Secretary, National Council of  
Educational Research and Training,  
Sri Aurobindo Marg, New Delhi  
110 016 and printed at Laxmi Print  
India, 519/1/23, Sansar Industrial  
Complex, Dilshad Garden, Delhi  
110095

**ALL RIGHTS RESERVED**

- ❑ No part of this publication may be reproduced, stored in a retrieval system or transmitted, in any form or by any means, electronic, mechanical, photocopying, recording or otherwise without the prior permission of the publisher.
- ❑ This book is sold subject to the condition that it shall not, by way of trade, be lent, re-sold, hired out or otherwise disposed of without the publisher's consent, in any form of binding or cover other than that in which it is published.
- ❑ The correct price of this publication is the price printed on this page, Any revised price indicated by a rubber stamp or by a sticker or by any other means is incorrect and should be unacceptable.

**OFFICES OF THE PUBLICATION**

**DIVISION, NCERT**

NCERT Campus  
Sri Aurobindo Marg  
New Delhi 110 016      Phone : 011-26562708

108, 100 Feet Road  
Hosdakere Halli Extension  
Banashankari III Stage  
Bengaluru 560 085      Phone : 080-26725740

Navjivan Trust Building  
P.O.Navjivan  
Ahmedabad 380 014      Phone : 079-27541446

CWC Campus  
Opp. Dhankal Bus Stop  
Panihati  
Kolkata 700 114      Phone : 033-25530454

CWC Complex  
Maligaon  
Guwahati 781 021      Phone : 0361-2674869

**Publication Team**

Head, Publication Division : *M. Siraj Anwar*

Chief Editor : *Shveta Uppal*

Chief Production Officer : *Arun Chitkara*

Chief Business Manager : *Bibash Kumar Das*

Production Officer : *Abdul Naim*

**Cover and Layout**

*DTP Cell, Publication Division*

## FOREWORD

The National Curriculum Framework–2005 (NCF–2005) recommends bringing work and education into the domain of the curricular, infusing it in all areas of learning while giving it an identity of its own at relevant stages. It explains that work transforms knowledge into experience and generates important personal and social values, such as self-reliance, creativity and cooperation. Through work, one learns to find one’s place in the society. It is an educational activity with an inherent potential for inclusion. Therefore, an experience of involvement in productive work in an educational setting will make one appreciate the worth of social life and what is valued and appreciated in society. Work involves interaction with material or other people (mostly both), thus, creating a deeper comprehension and increased practical knowledge of natural substances and social relationships.

Through work and education, school knowledge can be easily linked to learners’ life outside the school. This also makes a departure from the legacy of bookish learning and bridges the gap between the school, home, community and the workplace. The NCF–2005 also emphasises on Vocational Education and Training (VET) for all those children who wish to acquire additional skills and/or seek livelihood through vocational education after either discontinuing or completing their school education. VET is expected to provide a ‘preferred and dignified’ choice rather than a terminal or ‘last-resort’ option.

As a follow-up of this, NCERT has attempted to infuse work across the subject areas and also contributed in the development of the National Skill Qualification Framework (NSQF) for the country, which was notified on 27 December 2013. It is a quality assurance framework that organises all qualifications according to levels of knowledge, skills and attitude. These levels, graded from one to ten, are defined in terms of learning outcomes, which the learner must possess regardless of whether they are obtained through formal, non-formal or informal learning. The NSQF sets common principles and guidelines for a nationally

recognised qualification system covering Schools, Vocational Education and Training Institutions, Technical Education Institutions, Colleges and Universities.

It is under this backdrop that Pandit Sunderlal Sharma Central Institute of Vocational Education (PSSCIVE), Bhopal, a constituent of NCERT has developed learning outcomes based modular curricula for the vocational subjects from Classes IX to XII. This has been developed under the Centrally Sponsored Scheme of Vocationalisation of Secondary and Higher Secondary Education of the Ministry of Human Resource Development.

This textbook has been developed as per the learning outcomes based curriculum, keeping in view the National Occupational Standards (NOS) for the job role and to promote experiential learning related to the vocation. This will enable the students to acquire necessary skills, knowledge and attitude.

I acknowledge the contribution of the development team, reviewers and all institutions and organisations, which have supported in the development of this textbook.

NCERT would welcome suggestions from students, teachers and parents, which would help us to further improve the quality of the material in subsequent editions.

New Delhi  
June 2018

HRUSHIKESH SENAPATY  
*Director*  
National Council of Educational  
Research and Training

## ABOUT THE TEXTBOOK

Irrigation is the application of controlled amount of water to plants at needed intervals. There are several methods of irrigation. Flood irrigation, which involves flooding a field with water for irrigating plants, needs a large amount of water. Farmers in India, generally, practise flood irrigation, resulting in wastage of water and less water use efficiency. It also results in run-off surface and erosion of valuable top soil and nutrients.

Microirrigation, which includes drip and sprinkler irrigation, can help farmers conserve water and at the same time increase crop productivity, as water is delivered right at the root zone of plants.

Microirrigation system, which mainly comprises drip and sprinkler irrigation, has emerged as an effective tool for conserving water and improving water use efficiency. In microirrigation system, water is delivered through a network of pumps, filters, valves, pipes and drippers or emitters. Lack of awareness and knowledge about microirrigation technology, and the problems associated with its use and maintenance are the major hurdles in the adoption of this technology by farmers in our country.

A 'Microirrigation Technician', who designs and does the layout of a microirrigation system, procures material required for the installation, testing and commissioning of the system in a farm. The technician can help farmers use microirrigation system efficiently and effectively. The person can provide maintenance services for ensuring uninterrupted water supply to the plants in the farm.

The textbook for the job role of 'Microirrigation Technician' has been developed to impart knowledge and skills to students through activities and hands-on-learning experience. It has been developed with the contributions of subject and industry experts, as well as, academicians for making it a useful and enriching teaching-learning resource material for the students, who opt for this job role. Care has been taken to align the content of the textbook with the National Occupational Standards (NOSs) for the job role so that the students acquire knowledge and skills

as per the NOSs mentioned in the Qualification Pack (QP). The textbook has also been reviewed by experts so as to make it a quality reading material.

The textbook has three Units. Unit 1 gives an introduction to microirrigation system. The students are introduced to different types of microirrigation systems and how they help in agriculture. It also deals with land gradient and suitability of irrigation systems so that the students can understand the benefits of microirrigation systems over surface irrigation systems. Besides, it provides information on the design and layout of microirrigation system. In Unit 2, components of sprinkler irrigation system; tools, equipment and material required for the installation of the system; selection and suitability of pump; and installation of pipe networks and risers have been dealt with. Unit 3 covers the operation and monitoring of sprinkler irrigation system and the maintenance of sprinkler and drip irrigation systems so that the students can develop the necessary knowledge and skills for scheduling and maintaining a microirrigation system.

Vinay Swarup Mehrotra  
*Professor and Head*  
Department of Agriculture  
and Animal Husbandry  
PSSCIVE, Bhopal

# TEXTBOOK DEVELOPMENT TEAM

## MEMBERS

Appasaheb Maruti Ransing, *Senior Associate Engineer*, Jain Irrigation Systems Ltd., Jain Plastic Park, NH No. 6, P.O. Box-72, Jalgaon, Maharashtra

Kondapally V. Ramana Rao, *Principal Scientist*, Irrigation and Drainage Engineering Division, Indian Council of Agricultural Research (erstwhile, Central Institute of Agricultural Engineering), Berasia Road, Nabi Bagh, Bhopal, Madhya Pradesh

P.K. Singh, *Professor*, Department of Irrigation and Drainage Engineering, G.B. Pant University of Agriculture and Technology, Pantnagar, Uttarakhand

Satish Chandra, *Former Assistant Director General (Crop Improvement)*, Indian Council of Agricultural Research (Indian Agricultural Research Institute), 210B, Pocket 1, Mayur Vihar Phase-I, New Delhi

V. Ravi Kumar R., *Professor and Head*, Department of Soil and Water Conservation Engineering, Agriculture Engineering College and Research Institute, Kumlur, Trichy, Tamil Nadu

## REVIEWER

Murtaza Hasan, *Principal Scientist*, Centre for Protected Cultivation Technology, Indian Agricultural Research Institute, Pusa, New Delhi

## MEMBER-COORDINATOR

Vinay Swarup Mehrotra, *Professor and Head*, Department of Agriculture and Animal Husbandry, Curriculum Development and Evaluation Centre and NSQF Cell, PSSCIVE, Bhopal, Madhya Pradesh

## ACKNOWLEDGEMENTS

The Council expresses its gratitude to all members of the Project Approval Board (PAB) and officials of the Ministry of Human Resource Development (MHRD), Government of India, for their cooperation in the development of learning outcome-based curricula and courseware.

Rajesh P. Khambayat, *Joint Director*, PSSCIVE, Bhopal, is acknowledged for rendering relentless support in developing this textbook. The Council also express its gratitude to Saroj Yadav, *Professor and Dean (Academic)*, NCERT, and Ranjana Arora, *Professor and Head*, Department of Curriculum Studies (DCS), for their efforts in coordinating workshops for the review and finalisation of this textbook.

Thanks are due to all contributors and our colleagues at NCERT for sharing their knowledge, expertise and time by responding to our requests.

We express our gratitude to R.M. Singh, *Professor*, Banaras Hindu University, Varanasi; Sudhir Singh Dhakad, *Scientist*, Krishi Vigyan Kendra, Shajapur; K.C. Mahajan, *Assistant Professor*, College of Agriculture, Ganjbasoda; K.S. Bhargava, *Scientist*, Krishi Vigyan Kendra, Devas; and Afsa M. Yasin, *Former Professor*, PSSCIVE, Bhopal for their contributions in the development of this textbook.

We are also thankful to officials in the National Skill Development Agency (NSDA), National Skill Development Corporation (NSDC), and Ministry of Skill Development and Entrepreneurship for their support. Sunita Koli, *Computer Operator (Grade III)*, PSSCIVE, Bhopal, is acknowledged for typing the manuscript.

The images used in the textbook have been sourced from the Creative Commons License and have been selected with care and diligence for clearer understanding of the learners. Care has been taken not to violate any copyright issue. The images are meant for educational purposes and are being provided for the personal use of students and teachers.

Gratitude is also due to the Publication Division, NCERT, for transforming the manuscript into an attractive textbook. Special thanks are due to Sweta Jha, *Editor (Contractual)*, for copyediting and shaping this book. Pawan Kumar Barriar, *DTP Operator*, and Nitin Kumar Gupta, *DTP Operator (Contractual)*, Publication Division, NCERT are acknowledged for flawless layout design.



# CONTENTS

<i>Foreword</i>	<i>iii</i>
<i>About the textbook</i>	<i>v</i>
<b>Unit 1: Introduction to Microirrigation System</b>	<b>1</b>
Session 1: Microirrigation Systems	2
Session 2: Land Gradient and Suitability of Irrigation System	19
Session 3: Design and Layout of Microirrigation System	29
<b>Unit 2: Installation of Sprinkler Irrigation System</b>	<b>43</b>
Session 1: Installation of Components in Sprinkler Irrigation System	43
Session 2: Tools and Material for Installation of Sprinkler Irrigation System	52
Session 3: Classification and Suitability of Pumps	55
<b>Unit 3: Operation and Maintenance of Microirrigation System</b>	<b>67</b>
Session 1: Operation and Monitoring of Sprinkler Irrigation System	67
Session 2: Maintenance of Sprinkler Irrigation System	70
Session 3: Maintenance of Drip Irrigation System	79
<i>Glossary</i>	<i>85</i>
<i>Answer Key</i>	<i>90</i>

## *Do You Know*

According to the 86<sup>th</sup> Constitutional Amendment Act, 2002, free and compulsory education for all children in 6-14 year age group is now a Fundamental Right under Article 21-A of the Constitution.

**EDUCATION IS NEITHER A PRIVILEGE NOR FAVOUR BUT A BASIC HUMAN RIGHT TO WHICH ALL GIRLS AND WOMEN ARE ENTITLED**

*Give Girls  
Their Chance !*



# Unit 1



## Introduction to Microirrigation System

In India, perhaps more than 80 per cent of the available water is used for irrigation. Irrigation is the controlled application of water through man-made systems to meet the water requirements of agriculture. Irrigation is an artificial application of water to crops or plants, especially when an agricultural field does not get enough water through rains. Having perhaps the largest irrigated area in the world, India faces acute water scarcity. We need to adopt irrigation methods that help in not only in saving freshwater, but also provide sufficient water to plants for growth. One such method now being followed in India is 'microirrigation'.

In this Unit, you will learn about the main features and functions of drip and sprinkler irrigation system. The Unit also deals with the classification of microirrigation system, types of drip and sprinkler irrigation system, characteristics of land gradient, crops grown under microirrigation system, and the various aspects related to layout and design of the system.

Sprinklers spraying water over lawns, gardens and agricultural fields, are a common sight in both urban and rural areas. They not only spray water evenly but also help conserve the valuable natural resources. In sprinkler irrigation system, the sprinklers sprinkle



171108CH01

The Government of India launched the *Pradhan Mantri Krishi Sinchai Yojana* (PMKSY) or *Prime Minister's Agriculture Irrigation Programme*, with the slogan 'Per Drop More Crop' in July 2015. It is a policy initiative to shift towards microirrigation so as to 'save' water in agriculture and boost crop yield.

## NOTES

water into the air through nozzles, which subsequently, break into droplets and fall on crop canopy as well as the field surface.

You might have seen certain equipment, pipes and drippers in nurseries and agricultural fields through which water is supplied to irrigate plants directly. This mostly happens in drip irrigation system, wherein the water is supplied to plant roots directly through a network of plastic pipes, lateral tubes, valves and emitters.

### SESSION 1: MICROIRRIGATION SYSTEMS

Microirrigation is the slow application of continuous drips, tiny streams or miniature sprays of water above or below the soil surface. In this Session, you will learn about the main features of microirrigation system and its classification.

Microirrigation system is effective in saving water and increasing water use efficiency as compared to the conventional surface irrigation method. Besides, it helps reduce water consumption, growth of unwanted plants (weeds), soil erosion and cost of cultivation.

Microirrigation can be adopted in all kinds of land, especially where it is not possible to effectively use flooding method for irrigation. In flooding method of irrigation, a field is flooded with water. This results in significant run-off, anaerobic conditions in the soil and around the root zone, and deep irrigation below the root zone, which does not supply sufficient water to the plants. It is, therefore, one of the most inefficient surface irrigation methods.

Microirrigation can be useful in undulating terrain, rolling topography, hilly areas, barren land and areas having shallow soils. According to depth, soil types can be classified as shallow (depth less than 22.5 cm), medium deep (22.5–45 cm) and deep soil (more than 45 cm).

#### Features of microirrigation system

- Water is applied via pressurised piping system. Microirrigation requires pumps for developing the required pressure for delivering water through



pipelines, regardless of whether the source of water is surface or underground.

- Water is applied drop-by-drop for a long period in case of drip irrigation system.
- Water is applied at a low rate to maintain the optimum air-water balance within the root zone.
- Water is applied at frequent intervals as per the requirement of plants.
- Water is supplied directly to the plants and not to the other areas of the field, thus, reducing wastage.
- Soil moisture content is always maintained at 'field capacity' of the soil. Hence, crops grow at a faster rate, consistently and uniformly.

Field capacity is the moisture or water content present in the soil after excess water has drained away and the rate of downward movement has decreased, which takes place within 2–3 days after a spell of rain or irrigation. It means that after drainage stops, the large soil pores are filled with both air and water, while the smaller ones are still filled with water. At this stage, the soil is said to be at field capacity and is considered to be ideal for crop growth.

### **Classification of microirrigation system**

Microirrigation system can be broadly classified into two categories:

- (1) Drip irrigation system
- (2) Sprinkler irrigation system

However, there are distinct differences in the water flow rate, operating pressure requirement and measurement of the wetted area between drip and sprinkler irrigation systems. Water flow rate means the amount of water discharged in an area at a particular time. It is expressed in litre/minute (lpm) or gallons/minute (gpm). The system operating pressure must compensate for pressure losses through system components and field elevation effects.

### **Drip irrigation system**

Drip irrigation system, also known as 'trickle irrigation system', is a method of applying the required

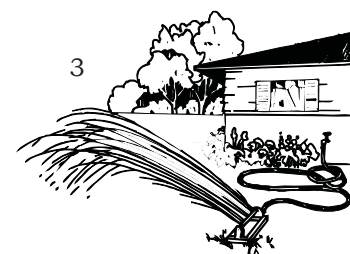

amount of water directly to the root zones of plants through drippers or emitters at frequent intervals. In this system, water is applied drop-by-drop or by a micro jet on the soil surface or sub-surface at a rate lower than the infiltration rate of the soil. The emitters dissipate pressure from the distribution system by means of orifices, vortexes and tortuous or long flow paths, thus, allowing a limited volume of water to be discharged. Most emitters are placed on ground but they can also be buried. The emitted water moves within the soil system largely by unsaturated flow. The water moves into the soil and wets the root zones of plants vertically by gravity and laterally by capillary action. The lateral movement of water beneath the surface is greater in medium to heavy soil as compared to sandy soil. The wetted soil area for widely spaced emitters will, normally, be elliptical in shape. Drip irrigation can be used on windy days and during various land operations.



*Fig. 1.1: Drip irrigation system in a garden*



## ***Types of drip irrigation system***

Drip irrigation system can be classified into the following:

- (i) Surface drip irrigation
- (ii) Sub-surface drip irrigation
- (iii) Family drip
- (iv) Online drip
- (v) In-line drip

### *Surface drip irrigation*

Surface drip irrigation is used to irrigate perennial crops (plants that live for more than two years) and annual crops (plants that germinate, produce seeds, flower and die in one year). Typical surface drip irrigation system consists of the following.

**Pump unit:** It comprises a pump and a power unit to supply electricity to the pump. The pump draws water from the source and provides the right pressure for its delivery into the pipe system.



*Fig. 1.2: Surface drip irrigation system*

**Head control unit:** It consists of shut-off, air and check (non-return) valves to control the discharge and pressure of water in the entire system. A pressure relief valve is installed after the pump unit to return excess water when the system is not operated at its full capacity. It may also have filters to clear the water. The filters remove sediment and debris, which can clog the system. Disc filters are commonly used to filter water from ponds, reservoirs, tanks and other sources that contain algae. Some head control units contain a fertiliser or nutrient tank to supply fertiliser solution to plants.

**Tubings:** It consists of a main line, sub-main lines or sub-mains and laterals. The main line conveys water from the source and distributes it to the sub-mains. The sub-mains convey water to the laterals, which in turn supply it to the emitters or drippers. The laterals are, usually, 13–32 mm in diameter and supply water into fields through the head control unit.

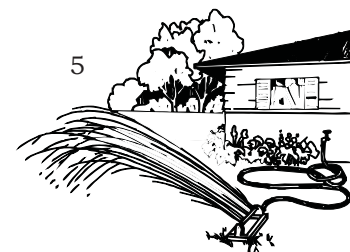

Emitters or drippers: These devices are used to control the discharge of water from the laterals to plants. They are made of High Density Polyethylene (HDPE) plastic. Water enters the drippers at approximately  $1 \text{ kg/cm}^2$  pressure and is delivered at zero pressure in the form of droplets at a low rate of 1–2.4 litre/hour. There are mainly two types of emitters.

(a) Online emitters: These are small plastic devices, which convey small streams of water from polyethylene (PE) tubing to the soil. The water, then, moves through the soil via capillary flow and creates a wetted circle, the size of which depends on the soil type, flow rate and irrigation schedule. Online emitters are attached to the PE tubing wall by inserting the emitters' barb-shaped base through a punched hole. These can be placed anywhere along the length of the pipe. Some emitters have self-piercing barbs. The diameter of pipes used for installing online emitters is usually, between 12 and 20 mm.

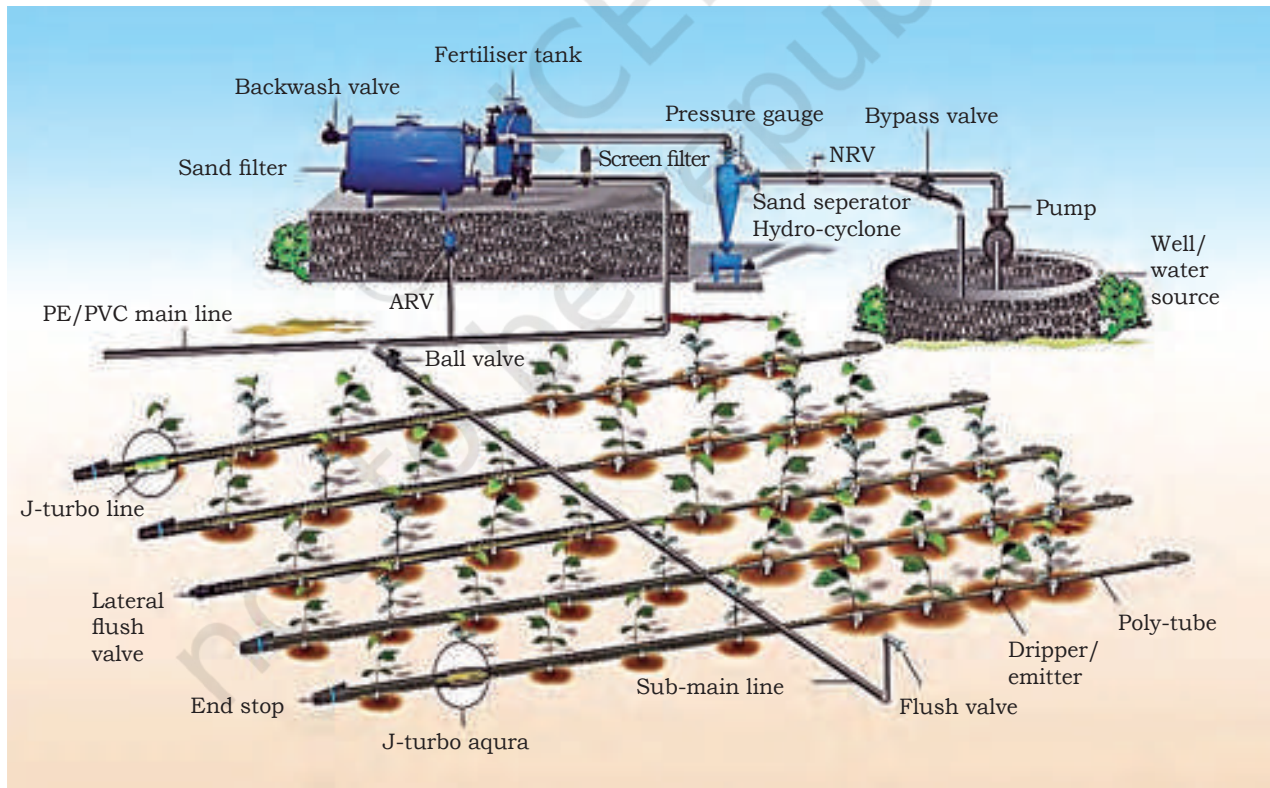

Fig. 1.3: Components of surface drip irrigation system





(b) In-line emitters or drip lines: These consist of small plastic emission devices, which are pre-inserted into the PE tubing at specified intervals during the tubing extrusion process. Their rate of water flow depends on the inlet pressure. With lower inlet pressure, the water flow decreases, whereas, with high pressure, it increases. This emitter is available in 0.8 lph to 4 lph discharge rate.

Surface drip irrigation system is, generally, used to irrigate high-value vegetable crops, such as tomato, broccoli, celery, cauliflower, spinach, *kohlrabi*, leaf lettuce, etc.

#### *Sub-surface drip irrigation*

Sub-surface drip irrigation is a method of irrigating crops through buried plastic tubes, containing embedded emitters located at regular spacings. A sub-surface drip irrigation system has a similar design as surface drip irrigation system. But in this case, the drip tubes are typically located 38–84" (97–213 cm) apart and 6–10" (15–25 cm) below the soil surface. In sub-surface drip irrigation, evaporation is minimised and water is used more efficiently as compared to surface irrigation.

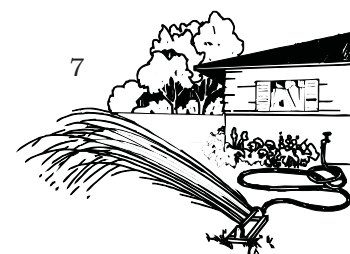

Fig. 1.4: Sub-surface drip irrigation

In sub-surface irrigation, the effects of surface infiltration like crusting, water losses via evaporation and surface run-off are eliminated. Water is applied directly to the root zone of a crop as opposed to surface irrigation, in which most weed seeds hibernate. Water application is efficient and uniform in this system. Sub-surface drip irrigation helps in water conservation in open field agriculture, often resulting in saving up to 25–50 per cent water as compared to the flood irrigation system.

#### *Family drip or gravity fed drip irrigation*

Family drip or 'gravity fed drip irrigation' system is a low-cost system developed for small family plots. It is suitable for house gardening and



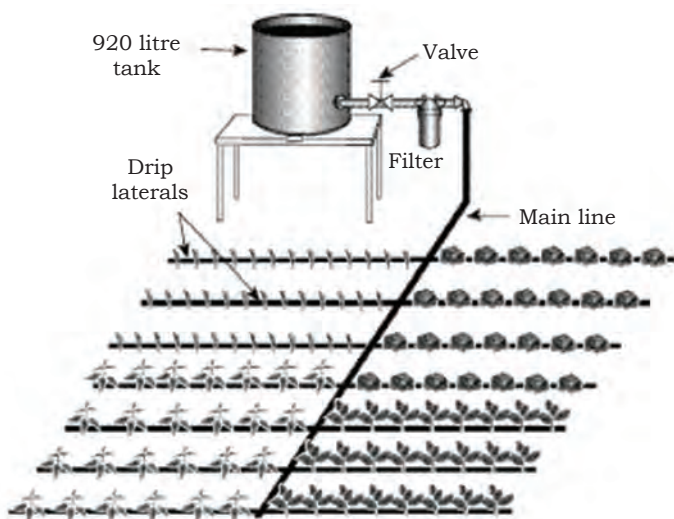

Fig. 1.5: Family drip irrigation



Fig. 1.6: Online drip irrigation

peri-urban agriculture. It can also be used to demonstrate the working of drip irrigation system. Family drip system is designed for areas measuring 500–1000 m<sup>2</sup>. It consists of five components — elevated tank, shut-off valve, filter, main line and drip line.

Generally, a family drip irrigation system comprises a drum, control or shut-off valve, filter (small disc or screen filter), main line and drip laterals. The drip outlets are spaced at 30 cm. No central pressurised water system or power source is required in this system. Therefore, it is cheap, easy to install and operate.

#### *Online drip irrigation*

In this system, emitters or drippers are fixed externally on the laterals at designed spacings. Thus, the drippers can be checked and cleaned easily in case of clogging. The dripper spacing can be changed any time to cover the increased root zone of a plant. Online dripper system is used in orchards, vineyards, artificial landscapes and nurseries. It is, generally, used for irrigating horticultural plants like mango, coconut, orange, lemon, banana, grapes, pomegranate, papaya, sapota, guava, teakwood, bamboo, *amla* (Indian gooseberry), etc.

#### *In-line drip irrigation*

In this system, drippers are fixed in the lateral tube at designed spacings at the time of manufacturing to meet the requirement of various crops. It is effective for row crops like cotton, sugarcane, groundnut, vegetables and flowering crops. Drinker spacing depends on the water



requirement of a crop and the water-holding capacity of the soil. Once installed, the dripper spacing cannot be changed.

### Sprinkler irrigation system

Sprinkler irrigation is a method of applying water in a manner similar to rain. It is suited for most row, field and tree crops. Water can be sprayed over or under the crop canopy. If a site is known to be windy most of the time, sprinkler irrigation will not be suitable. The sprinkler breaks up the water into droplets sized 0.5–4 mm. The drop size is controlled by pressure and nozzle size of the sprinklers. The average rate at which water is sprayed onto the crops is measured in mm/hour.

The application rate depends on the size of sprinkler nozzles, operating pressure and distance between the sprinklers. The application rate must not exceed the maximum allowable infiltration rate for the soil type. Excess application rate will result in water loss, soil erosion and surface sealing. There may be inadequate moisture in the root zone of crops or plants after irrigation and they may get damaged.

The force with which the water flows out of the sprinkler is known as its 'water pressure'. Water pressure is measured in pounds per square inch (psi). Sprinklers are, therefore, designed to work at certain pressure levels, which are recommended as their operating pressure. If the pressure is above or below than the recommended level, then the distribution of water will be affected. When the pressure is low, the water drops become larger and they cannot irrigate the crops that are far from the system. If the pressure is high, then the droplets will be smaller and the crops will not be irrigated evenly. It can also damage the sprinkler heads. Although sprinklers are adaptable to most soils, they are best suited for sandy soil. These can be used for irrigating lawns, gardens and agricultural fields.



Fig. 1.7: In-line drip irrigation

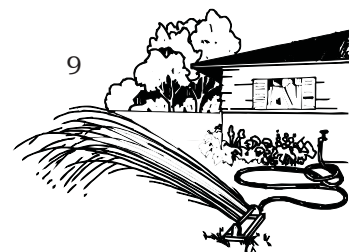



Fig. 1.8: Sprinkler irrigation

### **Types of sprinkler irrigation system**

- (i) Centre pivot
- (ii) Towable pivot
- (iii) Rain gun
- (iv) Impact sprinkler
- (v) Pop up sprinkler
- (vi) Linear move sprinkler

#### *Centre pivot*

The centre pivot is capable of irrigating most field crops. It consists of a single sprinkler lateral supported by a series of towers. It is anchored at one end and rotates around a fixed central point called 'pivot point'. The control panel attached to the pivot point gives commands to the central pivot machine. A drive unit or drive tower touches the ground, which contains necessary components for the machine to move. It consists of a base beam, drive train, wheels and other structural support equipment. The towers are self-propelled so that the lateral rotates around the pivot point installed in the centre of the irrigated area. The long pipes between the drive units are called 'spans'.



Spans consist of the main water line, sprinklers and a supporting structure to hold the weight between the towers. A tower box controls the drive unit components, with regard to the direction and duration.



(a)



(b)

Fig.1.9 (a and b): Centre pivot

### *Towable pivot*

Towable pivot is similar to centre pivot. But here, the pivot is towed away by a tractor. There are 3–4 wheels in the centre of the pivot, which make it possible to move the pivot from one place to another by pulling it with the help of the tractor. It helps farmers to carry out mechanised irrigation in an economical manner. It can easily irrigate fields as the machine can be towed away from one field to another in minimum time.

### *Rain gun*

A rain gun is used as a water spray mist or fog beam. It discharges water at less than 175 lph. It is used to irrigate trees and other crops separated widely. Fruit tree crops like citric fruits, mango, guava, avocado, etc., can be irrigated with a rain gun. The passage diameter of the rain gun is small. Therefore, the release of filtered water is essential,



Fig.1.10: Rain gun

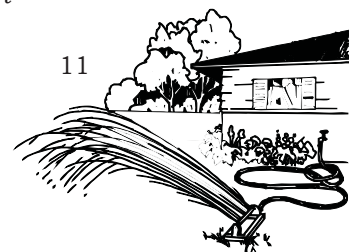

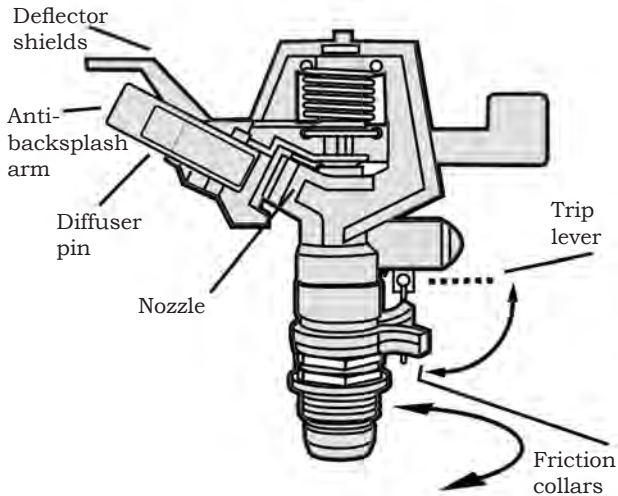

Fig.1.11: Impact sprinkler



Fig.1.12: Pop up sprinkler

amounting up to a requirement of 60–80 mesh (250 to 177 microns). The minimum operating pressure is 1.5–2 kg/cm<sup>2</sup>. The heads of rain gun are mounted on plastic wedges (or piles) 20–30 cm above the ground. Rain gun is suitable for field crops like groundnut, onion, potato, sugarcane, cotton and plantation crops, such as coffee and tea.

### *Impact sprinkler*

This sprinkler is driven in a circular motion by the force of outgoing water, and at least, one of its arms extends from the head. The sprinkler arm is repeatedly pushed back into the water stream by a spring. When the arm strikes the water stream, it scatters the stream and re-orientates the flow, enabling a uniform watering area around the sprinkler. Impact sprinkler is recommended for closely spaced field crops like potato, leafy vegetables, cotton, oilseeds, pulses, cereals, fodder crops, etc.

### *Pop up sprinkler*

A pop up sprinkler consists of an inlet, body, cap, wiper seal, riser, nozzle and radius adjustment screw. Such a sprinkler is portable and easy to install, thereby, making it ideal for irrigating lawns, seasonal flowers and planting beds.

### *Linear move sprinkler*

Linear move sprinkler irrigation system is similar to the centre pivot system in construction, except that neither end of the lateral pipeline is fixed. It is composed of a series of towers that are



suspended and move laterally in the direction of rows. The whole line moves down the field perpendicular to the lateral. Water delivery to the continuously moving lateral is by a flexible hose or open ditch pickup. Both the centre pivot and linear move systems are capable of high efficiency water application. By 'water efficiency', it means reducing water wastage by measuring the amount of water required for a specific purpose and the amount of water delivered or used. Such a system requires high capital investment but is not labour intensive.

### **Micro-sprinklers**

Micro-sprinklers are emitters, commonly, known as sprinkler or spray heads. They operate by spreading water through air, usually, in predetermined patterns. Depending on the water throw patterns, micro-sprinklers are referred to as 'mini-sprays', 'micro-sprays', 'jets' or 'spinners'. The sprinkler heads are external emitters individually connected to lateral pipes, typically, using what can be called 'micro-tubes' or a small diameter tubing. The sprinkler heads can be mounted on a support stake of 25–30 cm height, connected to the supply pipe. Micro-sprinkler system requires less energy, and generally, operates at a pressure range of 1–3 kg/cm<sup>2</sup> and a discharge range of 40–75 lph. Micro-sprinklers are desirable because fewer sprinkler heads are required to cover a large area. The system is suited for crops with shallow rooting pattern like garlic, onion, etc.



*Fig.1.13: Linear move sprinkler*

### **Other types of microirrigation system**

#### **Bubbler irrigation**

Bubblers are used to irrigate bigger areas and apply water on 'per plant' basis. Water from the bubbler head either runs down from the emission device or spreads a few inches in an umbrella pattern. Bubbler emitters

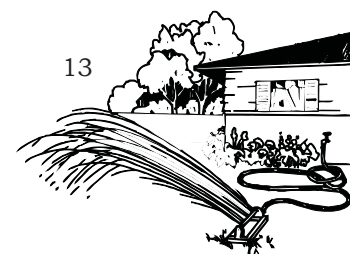



Fig. 1.14: Bubbler irrigation



Fig. 1.15: Spray irrigation

dissipate water pressure through a variety of diaphragm material (a silicon diaphragm inside an emitter flexes to regulate water output) and deflect water through small orifices. Bubbler emission devices are equipped with single or multiple port outlets. Bubblers are available in adjustable flow and pressure compensating types.

### Spray irrigation

In this system, jets, foggers or misters, also called 'spitters', are used. Water is applied only to a fraction of the ground surface. However, instead of dripping water from narrow orifice emitters, micro-sprayer systems eject fine jets that fan out from a series of nozzles. Each nozzle can water an area of several square metres, which tends to be much larger than individual areas wetted by a single drip emitter.

### Advantages of microirrigation system

As mentioned earlier, microirrigation system has a number of advantages over surface irrigation system. Some of the advantages of microirrigation system over surface irrigation system are described as follows.

### Helps in saving water

Water requirement in drip or sprinkler irrigation is much less as compared to any other conventional method of irrigation. This is because of irrigation of a smaller portion of land, decreased evaporation from the soil surface and reduction or elimination of run-offs. Waterlogging, which occurs under flat surface flood irrigation, is rare in case of microirrigation. Since microirrigation system allows high level of water control application, water can be applied only when needed and losses due to deep percolation can be minimised or avoided. Microirrigation can reduce water usage by 25–40 per cent as compared to overhead systems and 45–60 per cent as compared to surface irrigation.





## Uniform water application

Microirrigation systems ensure uniform water application. Therefore, all plants in a field receive equal amount of water. Higher uniformity results in efficient irrigation, thereby, causing less wastage of water, power and fertilisers. Consistent water application results in better and uniform crop yields as each plant is given the required amount of water and nutrients for optimum growth. Crop yield is the measurement of the amount of agricultural production harvested per unit area.

## Helps in saving electricity

Microirrigation systems require less electricity as compared to other systems. Usually, delivery pipe in microirrigation systems operate at low pressure (2–4 bar). Therefore, these require less energy for pumping.

## Improves chemical application

Microirrigation system can apply chemicals to plants through fertigation unit. 'Fertigation' is the application of fertilisers used for making soil amendments in order to improve plant growth. Since the fertilisers are applied directly to the root zones of the plants, a reduction in the total amount of fertiliser applied is possible, which saves an average of 25–50 per cent of the total cost. Microirrigation systems apply the right fertiliser to the plants at a given time. Herbicides, insecticides and fungicides can also be applied through microirrigation systems, and thereby, help improve the crop yield.

## Reduces weeds and diseases

Weeds are the unwanted plants that grow in lawns, gardens and agricultural fields. They compete with the crops for nutrients, moisture and sunlight, which can reduce the crop quality and the yield. These also serve as a habitat for diseases and insect-pests, which attack the main crop. Weed growth is inhibited in areas irrigated by drip irrigation as only a limited area gets irrigated. Hence, the threat of weeds and diseases is reduced.

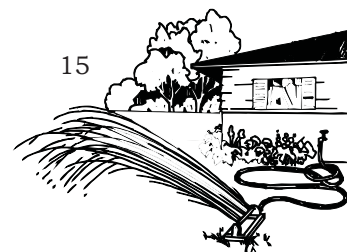

## NOTES

### Improves tolerance of crops to soil salinity

Microirrigation reduces the sensitivity of most crops to saline water or soil-water conditions due to high moisture content in the root zones of plants. Microirrigation (especially, drip irrigation) keeps the soil moisture continuously at a high level near the root zone, and thus, maintains a low level of salt concentration. Therefore, crops under microirrigation system are more tolerant to saline water.

### Suitable to various topography and soil type

Microirrigation systems can function efficiently on any topography, if appropriately designed and managed. Low water application rate with microirrigation systems is ideal for clayey soil as water can be applied slowly enough for the soil to absorb without any surface run-off.

### Regulates water through automation

Microirrigation system can be semi or fully automatic. It uses automatic controller, which can be simple mechanical clocks or timers that open or close the valve on a pre-set time schedule. These can be programmed to run at night when evaporation is low. A microirrigation system can be easily automated using electrical solenoid valves and a controller. This allows the system to operate at any time of the day and for any duration.

### Reduces labour costs

One of the major advantages of microirrigation system is that it reduces labour costs. Labour requirement is reduced as it is an automated system and does not require labourers to irrigate an area. A large area of land can be irrigated at once with microirrigation system.

### Improves quality and yield

Crop quality and yield is improved under microirrigation system because of slow, regular and uniform application of water and nutrients. Besides, damages and losses due to the contact of water with fruits or foliages are practically eliminated.



## Practical Exercise

### Activity

Visit a farm, where a microirrigation system has been installed. Discuss the following with the owner of the farm.

- (i) What are the advantages of drip or sprinkler irrigation system?
- (ii) In which crop(s), drip or sprinkler irrigation system has been more useful?
- (iii) What are the common problems that you encounter in maintaining drip or sprinkler irrigation system?

## Check Your Progress

### A. Multiple Choice Questions

1. If a site is known to be windy most of the time, \_\_\_\_\_ irrigation will not be suitable.  
(a) sprinkler  
(b) drip  
(c) both (a) and (b)  
(d) None of the above
2. \_\_\_\_\_ irrigation system makes use of very low pressure.  
(a) rain gun  
(b) gravity drip  
(c) drip  
(d) sprinkler
3. The wetted soil area for widely spaced emitters in drip irrigation system will normally be \_\_\_\_\_ in shape  
(a) round  
(b) elliptical  
(c) circular  
(d) triangular
4. The sprinkler breaks up water into small droplets, usually, of 0.5 to \_\_\_\_\_ mm in size.  
(a) 3  
(b) 5  
(c) 4  
(d) 2

### B. Fill in the Blanks

1. The \_\_\_\_\_ emitters dissipate water pressure through small orifices.
2. Microirrigation helps in reducing \_\_\_\_\_ consumption, weeds, soil erosion and the total cost of cultivation.

## NOTES

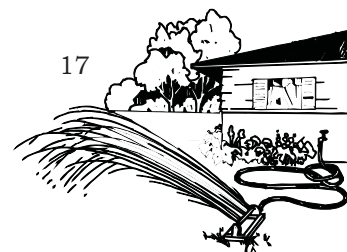

## NOTES

3. A \_\_\_\_\_ irrigation system can be used on windy days and during various land operations.
4. In microirrigation system, water is applied via \_\_\_\_\_ piping system.

### C. State True or False

1. One of the major advantages of microirrigation system over surface irrigation system is that it helps reduce labour costs.
2. A microirrigation system cannot be easily automated using electrical solenoid valves and a controller.
3. Crop quality and yield under microirrigation system is improved because of irregular application of water and nutrients.

### D. Subjective Questions

1. What are the different components of sprinkler irrigation system?
2. What are the advantages of microirrigation system?
3. Write a short note (100 words) on the following:
  - (i) Centre pivot
  - (ii) Rain gun
  - (iii) Impact sprinkler
  - (iv) Pop up sprinkler

## What have you learned?

### After completing this Session, you will be able to:

- describe the main features of a microirrigation system.
- identify the components of a microirrigation system.
- identify different types of drip irrigation system.
- identify different types of sprinkler irrigation system.
- describe the criteria for selecting a microirrigation system.
- state the advantages of using a microirrigation system.



## SESSION 2: LAND GRADIENT AND SUITABILITY OF IRRIGATION SYSTEM

## NOTES

Agricultural crops are cultivated in different agroclimatic conditions and topographies. Crops are grown in rain-fed, as well as, irrigated conditions for better yields. There are different irrigation methods suitable for various types of crop and land. To choose a suitable and efficient method of irrigation, a farmer must know the advantages and disadvantages of various irrigation methods. Irrigation systems are implemented primarily to save water and increase water use efficiency in agriculture. 'Water use efficiency' is the ability of a crop to produce biomass per unit of water transpired.

The method of irrigation to be adopted is, generally, determined by the type of soil, topography of land, water source (surface or underground) and the crop to be irrigated. 'Topography' is the slope of the ground and how much uneven or levelled it is. The irrigation method is selected accordingly. A topographic map is one that contains information about the general topography of an area. The map includes contour lines, location of natural features like gullies and ditches, and man-made features, such as buildings, roads, culverts, bridges, etc. These are needed for detailed planning of the irrigation method to be used.

### Land gradient

Land or field gradient and uniformity are important factors that are considered for determining the type of irrigation method to be used. 'Gradient' refers to the 'slope of land'. It is calculated by dividing the rise (vertical difference) by the run (horizontal difference). The magnitude or size of gradient is the 'slope', while the direction in which the maximum value of this magnitude occurs is known as 'aspect'. Slope gradient is a key factor in influencing the relative stability of a slope. Slopes are often irregular and complex.

If the slope of the land is 0.4–8 per cent, corrugation method of irrigation (e.g., furrow irrigation) is suitable. If the slope is more, then sprinkler method is more suitable for soils that are shallow and have faster permeability.

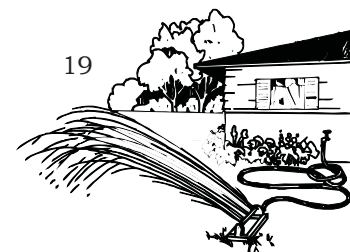

## NOTES

The land to be irrigated is levelled to obtain the required surface and drainage. Land levelling modifies the land surface for efficient surface irrigation. Pressurised irrigation methods may not need high degree of land levelling, whereas, surface irrigation methods need slight land grading and levelling.

### **Selection of irrigation method**

There are several factors that need to be considered while selecting an irrigation method. A farmer or land owner must have knowledge of the soil condition, topography, size and shape of a field, cropping system and labour availability.

In pressurised irrigation system, water is applied to plants under pressure through a network of pipes and pumping system. This system may not be feasible unless energy resources are available at reasonable cost. For example, a farmer must have access to electricity supply in order to run a pump unit, which is needed to dissipate water with pressure.

Development and annual operational costs are the most important factors while selecting an irrigation method. It is not only the equipment, construction and installation cost but also the operation cost that needs to be taken care of. These costs must be compared with the expected yield benefits. The farmers will be interested in implementing a certain method only if they find it economically attractive.

### **Irrigation systems**

There are two types of irrigation system — gravity flow or surface irrigation and pressurised irrigation

#### **Gravity flow irrigation system**

Gravity flow or 'surface irrigation system' refers to the application and distribution of water from higher to a lower topography by gravity flow. In this method, the land to be irrigated must have a gentle slope, else the cost of land levelling and preparation go may up considerably. It is by far the most common form of irrigation method in the world. There are four basic methods of surface irrigation.

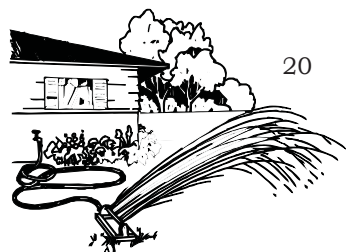

- (i) Border-strip irrigation
- (ii) Check basin irrigation
- (iii) Furrow irrigation
- (iv) Wild-flooding irrigation

### ***Border-strip irrigation***

In this method of irrigation, the field is divided into a number of long parallel strips called 'borders'. These borders are 2–10 m wide and 52–300 m long, depending on the soil type and slope of the field. Parallel earth bunds or levees are made in order to guide the advancing water. These borders are separated by low ridges. The border strip has a uniform gentle slope in the direction of irrigation. The water spreads and flows down the strip in a sheet confined by the border ridges. Examples of crops irrigated by this method include wheat, leafy vegetables and fodder. However, the method is not limited only to these plants.

### ***Check basin irrigation***

In this method, the field is divided into smaller areas so that each has a nearly level surface. Bunds or ridges are constructed around each area, forming basins, within which the irrigation water can be controlled. The water applied to a desired depth can be retained until it infiltrates into the soil. The size of the basins is 10–25 m<sup>2</sup>,



*Fig. 1.16: Check basin irrigation*

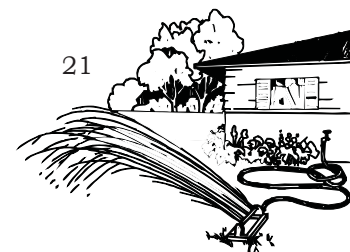

depending on the soil type, topography, stream size and crop. It is the most common method of irrigation. The shape and size of basins are mainly determined by land slope, soil type, stream size available, required depth of the irrigation application and agricultural practices. Examples of crops irrigated by this method include maize, rice, wheat, barley, etc.



*Fig. 1.17: Furrow irrigation*

### ***Furrow irrigation***

In this method of surface irrigation, water is applied to the field through furrows, which are small canals having continuous or nearly uniform slope in the direction of water flow. The furrows are, generally, V-shaped or U-shaped in cross section and are 15–30 cm deep and 25–40 cm wide at the top. Water flowing into the furrows spreads laterally to irrigate the area between the furrows. The rate of lateral spread of water into the soil depends on the soil type, i.e., for a given time, water will infiltrate more vertically and less laterally in relatively sandy soil than in clayey soil. The spacing of furrows depends on the crop type and the type of machinery used for cultivation and planting. Shallow-rooted crops require shallow furrows. Examples of crops irrigated by this method include cotton, sugarcane and potato. However, the method is not limited only to these plants.

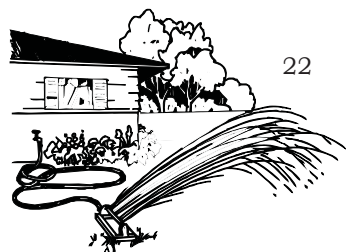



**Wild-flooding irrigation**

In this method of irrigation, water is applied from field channels without a ridge to guide its flow or control. This is the most inefficient method of surface irrigation.

**Pressurised irrigation system**

Pressurised irrigation system includes drip, sprinkler and an array of similar systems, in which water is distributed over the farmland through pressurised network of pipes.

**Factors influencing suitability of irrigation system**

The suitability of various irrigation methods, i.e., surface, sprinkler or drip depends mainly on the following factors.

- (i) Natural conditions
- (ii) Crops
- (iii) Technology
- (iv) Labour inputs
- (v) Cost

**Natural conditions**

Natural conditions, such as soil type, slope, climate, water quality and availability have the following impacts on the choice of an irrigation method.

Soil type	Sandy soil, which contains more than 85 per cent standardised particles by mass, have a low water storage capacity and a high infiltration rate. They, therefore, need frequent but small irrigation application, particularly, when the soil is shallow. Under these circumstances, sprinkler or drip irrigation is more suitable than surface irrigation.  In loamy or clayey soils, all three irrigation methods can be used but surface irrigation is the most common. Surface irrigation is ideal for clayey soil having low infiltration rate.
Slope	Sprinkler or drip irrigation is preferred to surface irrigation on steeper or uneven sloping lands as they require little or no levelling. If an area to be irrigated has a high slope gradient, then a tapered pipeline can be used to economise on pipe costs and keep pressure head variations within the desired limits.

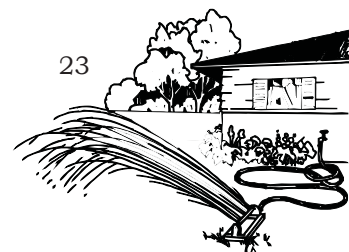

## NOTES

Climate	The major climatic factors, which influence crop water needs are sunlight, temperature, humidity and wind speed. For example, strong winds can disturb the spraying of water by sprinklers. Therefore, drip or surface irrigation methods are preferred in windy conditions. In areas of supplementary irrigation, sprinkler or drip irrigation may be more suitable than surface irrigation as these can be adapted to meet varying irrigation demands on a farm.
Water application efficiency	Water application efficiency is, generally, higher in sprinkler and drip irrigation than surface irrigation. Therefore, these methods are preferred when water is in short supply.
Water quality	Surface irrigation is preferred if the irrigation water contains sediments. Sediments may clog the drip or sprinkler irrigation system. If the irrigation water contains dissolved salts, then drip irrigation is suitable as less water is applied to the soil as compared to surface irrigation. Sprinkler irrigation system is more efficient than surface irrigation, where leaching out of nutrients is likely a problem.

Let us now look at the suitability of some of the surface irrigation methods vis-à-vis land gradient.

Irrigation methods	Land gradients
Basin irrigation	It is the simplest of all surface irrigation methods. Flat lands, with a slope of 0.1 per cent or less, are suited for basin irrigation. In such a case, little land levelling is required. If the slope is more than 1 per cent, terraces can be constructed.
Furrow irrigation	This irrigation method can be used on flat (short and near horizontal furrows) and mildly sloping land with a slope of maximum 0.5 per cent. On steeper sloping land, contour furrows can be used up to a maximum land slope of 3 per cent.
Border irrigation	This can also be used on sloping land. A minimum slope of 0.05 per cent is recommended to ensure adequate drainage. If the infiltration rate is more than 30 mm/hour, then sprinkler or drip irrigation must be used.

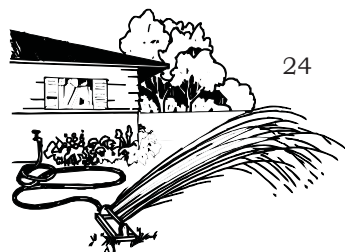

## Crops

Different crops have different water requirements. They need specific amounts of water at various stages of their growth and ripening. Some crops need more water, whereas, others require less water. For example, paddy is transplanted in standing water and requires continuous irrigation, whereas, crops like wheat, gram and most vegetables do not require as much water.

### **Growth stage of crops**

There are, generally, four growth stages of crops, during which the water requirement varies.

#### *Initial stage*

The period from sowing or transplanting, until the crop covers about 10 per cent of the ground. During this stage, the crop uses little water.

#### *Crop development stage*

This stage starts at the end of the initial stage and lasts until the full vegetative stage has reached (70–80 per cent). At this stage, water consumption increases.

#### *Mid-season stage*

It starts at the end of the crop development stage and lasts until maturity, which includes flowering and grain-setting. During this stage, water consumption reaches its peak.

#### *Late-season stage*

This stage starts at the end of the mid-season stage and lasts until the last day of the harvest, which includes ripening. During this stage, the maturing crop requires less water.

### **Crop sensitivity**

Crop sensitivity to water stress varies from one growth stage to another. 'Crop-water use', also known as 'evapotranspiration' (ET), is the water used by a crop for growth and cooling. This water is extracted from the root zone by the root system, which represents transpiration. Crop-water use at critical growth stages can be used in irrigation scheduling to avoid stressing

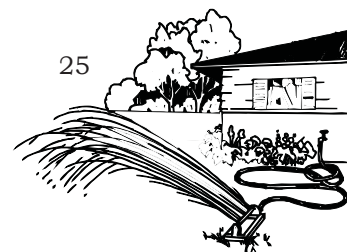

## NOTES

crops. Crop sensitivity is weather dependent, as well as, soil, water and plant dependent.

### ***Irrigation scheduling scheme***

An irrigation scheduling scheme must consider the sensitivity of a crop to water stress at different growth stages. The purpose of an irrigation scheduling is to keep the water content in the root zone above the allowable water depletion level. This ensures that the crop will not suffer from water stress and will produce optimum yield. For irrigation scheduling, it is necessary to know how much water (in mm) is to be applied per irrigation application.

### ***Irrigation requirement***

Crop-water requirement in irrigation is defined as the quantity of water needed by a crop at a given time for its growth under open field conditions. It includes evaporation and other unavoidable water losses. Water requirement is expressed in water depth per unit area. Irrigation requirement is based on the type of crop, soil and climate. The net irrigation water requirement is the depth of irrigation water, exclusive of precipitation, stored moisture or groundwater that is required consumptively for crop production and other purposes, such as leaching out. It is expressed in millimeters per year.

### ***Required depth of irrigation application***

Surface irrigation can be used for all type of crops. Furrow irrigation is best used for irrigating row crops, such as maize, vegetables and trees. Border irrigation is, particularly, suitable for close growing crops but can also be used for row crops and trees.

In case of surface irrigation methods, maximum water is applied per irrigation. Usually, 40–70 mm water is applied in basin irrigation, 30–60 mm in border irrigation and 20–50 mm in furrow irrigation. For example, on sandy soil and a shallow rooting crop, furrow irrigation will be the most appropriate. If a large amount of water is to be applied per application, e.g., on clayey soil and a deep rooting crop, border or basin irrigation will be more appropriate.

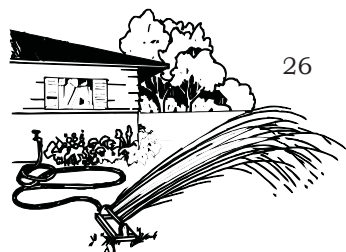

Sprinkler and drip irrigation are mostly used for high-value cash crops as they involve high investment for installation and operation of equipment. Sprinkler irrigation can be chosen for eliminating the possibility of levelling a land when:

- the soil is too shallow.
- it is too steep (>1% slope).
- light (<5 cm) and frequent irrigations are to be given.
- the soil is sandy (rapidly permeable coarse textured soil) with poor water selection.
- supplementary irrigation is to be given to dry land crops during prolonged dry spells, without any land preparation.

Drip irrigation is suitable for irrigating individual plants, trees or row crops, such as vegetables and sugarcane. It is considered to be less suitable and economical for close growing crops like rice.

### Technology

The choice of irrigation method is also influenced by technology. In general, drip and sprinkler irrigation require advanced technological know-how. They are not only capital intensive but also require regular maintenance. Surface irrigation system, usually, requires less sophisticated equipment for construction and maintenance. However, the equipment are less efficient as compared to those used in drip and sprinkler irrigation systems.

### Labour inputs

Surface irrigation often requires more labour input for construction, operation and maintenance than sprinkler or drip irrigation. It requires considerable land levelling and regular maintenance, whereas, sprinkler and drip irrigation require little land levelling and maintenance, and hence, are less labour-intensive. Labour and water requirement are high in case of furrow irrigation. In case of soils with steep or irregular slopes, high infiltration rate and water scarcity, sprinkler and drip irrigation may be more appropriate.

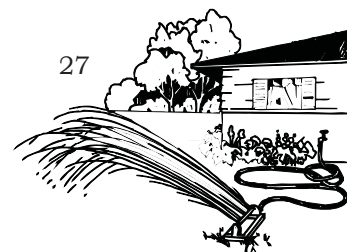

### Costs

The installation of a microirrigation system is capital intensive as it requires higher investment than surface irrigation system. However, if the investment is evaluated based on the cost benefit analysis, then microirrigation system has a major benefit. A farmer, using microirrigation system, experiences and increase in crop yield, which leads to a rise in the annual income.

Significant returns from microirrigation are possible if the farmer makes judicious selection of crops and follows the standard operating procedures.

### Practical Exercise

#### Activity

Visit a nearby agricultural field and study the following:

- (i) types of soil, water sources and crops grown
- (ii) different irrigation methods used by the farmers working there
- (iii) reasons for using a particular irrigation method by the farmers

### Check Your Progress

#### A. Multiple Choice Questions

1. Sandy soils have \_\_\_\_\_ .
  - (a) low water storage capacity
  - (b) high infiltration rate
  - (c) more than 85 per cent sand particles by mass
  - (d) All of the above
2. Sprinkler and drip irrigation are mostly used for high-value cash crops, such as vegetables and fruits because of \_\_\_\_\_ .
  - (a) high capital investment
  - (b) low capital investment
  - (c) less requirement of water
  - (d) None of the above

#### B. Fill in the Blanks

1. A \_\_\_\_\_ soil has low water storage capacity and high infiltration rate.
2. Strong \_\_\_\_\_ can disturb the spraying of water by sprinklers.

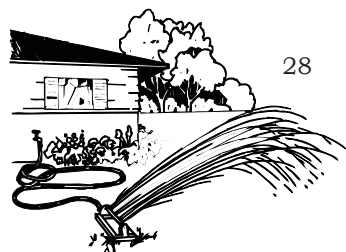

3. Surface irrigation is preferred, if the irrigation water contains much \_\_\_\_\_.
4. Surface irrigation often requires more \_\_\_\_\_ input for construction, operation and maintenance than sprinkler or drip irrigation.
5. Surface irrigation requires accurate \_\_\_\_\_ levelling and regular maintenance.
6. Sprinkler and \_\_\_\_\_ irrigation require little land levelling as compared to surface irrigation.
7. In soils with steep or irregular slopes, high infiltration rate and scarcity of \_\_\_\_\_, sprinkler and drip irrigation may be more appropriate.

**C. State True or False**

1. Strong winds cannot disturb the spraying of water from sprinklers.
2. Under strong wind conditions, drip or surface irrigation methods are not preferred.
3. Surface irrigation systems, usually, require less sophisticated equipment for both construction and maintenance.

What have you learned?

**After completing this Session, you will be able to:**

- describe the factors that determine the suitability of an irrigation system.
- describe the various aspects of land gradient that need to be considered while selecting and installing an irrigation system.
- describe the factors that influence crop-water requirements.
- correlate crop water requirement with the required depth of irrigation application.

**SESSION 3: DESIGN AND LAYOUT OF MICROIRRIGATION SYSTEM**

Microirrigation systems must aim at maximising the returns and minimising the cost per unit volume of water used, thus, contributing to the overall reduction in the total investment. Planning and purchasing the correct components are the key factors for the installation and smooth functioning of a microirrigation

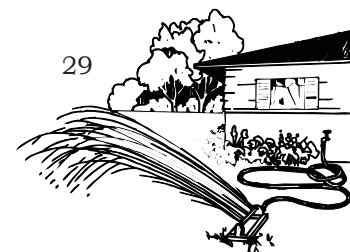

## NOTES

system. A checklist of tools, equipment and material required to install the system must be prepared before purchasing them.

### **Design and layout**

The primary objective is to choose the appropriate layout and components required for installing a microirrigation system in order to attain adequate and uniform distribution of water and nutrients across the field at high efficiency. Information, preferably, backed by data on crop, cropping pattern, irrigation water quality, topography, soil characteristics and climate are required for planning the layout and design of the microirrigation system.

The basic steps that need to be followed while planning the design and layout the microirrigation system are as follows.

### Collection of basic farm data

Farm data may include layout of the area, details of water source, soil type, agronomic details (plants to be grown, crop spacing, crop period, etc.) and climatic data (temperature, rainfall, evapotranspiration, etc.). It may also include the topographic map of a farm, showing the area to be irrigated. The map contains contour lines, farm boundaries, water source(s), roads and electricity lines. The basic farm data also include the quantity and quality of water available, climate of the area and its influence on the water requirements of the selected crops, soil characteristics, type of crops intended to be grown and current agricultural practices.

### Analysis of the data

The collected farm data is analysed to understand the irrigation requirements of the crops, infiltration rate of the soil to be irrigated, depth of water application per irrigation, irrigation frequency and cycle, system capacity, etc. 'Irrigation frequency' is the time it takes a crop to deplete the soil moisture at a given soil moisture depletion level. Depth of water application refers to the quantity of water, which needs to be applied during irrigation in order to replenish the water used by the crop during evapotranspiration.





## Preparation of microirrigation system layout

The microirrigation system layout for the field is prepared after taking into account the affordability of a farmer. Microirrigation system design starts with the selection of emitters, which depends on the type of crop, water requirement, operating time, soil type and water quality. Layout includes alignment of the network of main, sub-main and lateral pipes, and their connection with a water source. The whole area is then divided into units, depending on the number of sub-mains to be installed, keeping in view the pumping capacity of the pump. The main line is then planned for connecting to the sub-mains by considering the shortest possible route. The length of the main line is determined on the basis of the water flow rate so that the frictional head loss is within the specified limits and the total pressure head required for the system is within the pump capacity.

### Water sources

Surface and groundwater are the main sources of water supply for agricultural purposes. One always needs to locate the water source before installing a microirrigation system. The location of water source needs to be marked on a map. The following information with regard to the water source must be collected.

- Height above the ground level or depth from the ground surface
- Details of the pump to be installed
- Quality of water in terms of impurities present (sand, silt, algae, etc.)

The various sources of surface and underground water, which can be utilised for irrigation purposes, are tanks, canals, wells, lakes, rivers, ponds, reservoirs, streams, etc. Surface water contains large amount of impurities, therefore, it must be filtered before use. Fig. 1.18 shows the symbol that is commonly used to represent the water source on an irrigation plan.



Fig. 1.18: Symbol for water source

### Tanks

In India, tanks are the most popular source of irrigation, especially in States like Tamil Nadu, Karnataka, Andhra

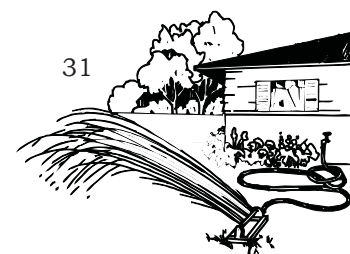

## NOTES

Pradesh, Telangana and Maharashtra. Most tanks are small in size and built by individuals or groups of farmers by raising bunds across seasonal streams. Evaporation of water is relatively rapid in tanks due to large expanse of shallow water. However, tanks do not provide perennial water supply. In small areas, plastic overhead tanks can also serve the purpose of supplying water to the main and sub-main lines of the microirrigation system.

### Canals

Canals are the second most important source of irrigation in India. Canal irrigation is possible in areas that are extensive like plains and are drained by perennial rivers, such as the northern plains, coastal plains, deltas and broad valleys of the Indian peninsula. The plain areas of India are mostly canal irrigated. States that follow canal irrigation system are Andhra Pradesh, Assam, Haryana, West Bengal, Punjab, Rajasthan, Bihar, Karnataka, Tamil Nadu and Uttar Pradesh.

### Wells

Wells are an important source of irrigation. The water in wells is obtained from the sub-soil and has to be extracted manually, using animal power or pumps. Well irrigation is most common in alluvial plain areas, where the water table is high. States having 50 per cent or more irrigated area under wells and tubewells are Punjab, Uttar Pradesh, Rajasthan, Gujarat, Maharashtra, Madhya Pradesh and Tamil Nadu.

### Design of drip irrigation system

Drip irrigation, also known as 'trickle irrigation', is a planned irrigation system, in which water is applied directly to the root zones of plants by means of applicators (orifices, emitters, porous tubing, perforated pipes, etc.) operated under low pressure. The applicators are placed either on or below the surface off the ground. As already mentioned in Session 1, drip irrigation system consists of pump unit, head control unit, main line, sub-main lines or sub-mains, laterals and emitters or drippers.



The design of surface drip irrigation system must describe the pump requirements. There is a range of options for the type of filter. There are filters with mesh, disc and media type. A major consideration in the design of surface drip irrigation system is drip tubing lateral spacing. In normal irrigation design, the pipe size must be specified based on economic and friction loss, and water hammer considerations. Drip line depth will depend on soil characteristics, rooting depth and cultivation practice being followed in a field. Soil having more sand content requires closer spacing of drip tubing laterals, which increases the cost of the drip irrigation system. Wider spacings are possible with heavy soil, which contains more clay (e.g., black soil), as lateral movement of water is greater in such soil.

### Typical spacing of 4 lph (1.06 gph) emitters

Coarse soil (sand): 60 cm (24")

Medium soil: 1m (39")

Fine soil (clay): 1.3 m (48")

### Typical spacing of 2 lph (0.53 gph) emitters

Coarse soil (sand): 30 cm (12")

Medium soil: 60 cm (24")

Fine soil (clay): 1 m (39")

### Components and symbols of drip irrigation system

#### **Pump unit**

The pump unit lifts water and produces the desired pressure for distributing water through emitters. Electric motor driven pumps can be activated using a pump start relay that is activated by a computer.

#### **Head control unit**

It consists of valves to control the discharge and pressure of water in the entire system. It may also have filters to clean the water. The head control unit turns the automatic valves on or off through control signals. These valves then run water to the required sections.

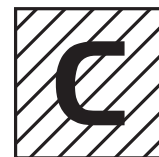
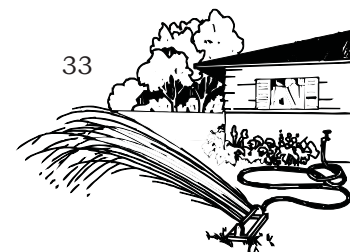

Fig. 1.19: Symbol for head control unit



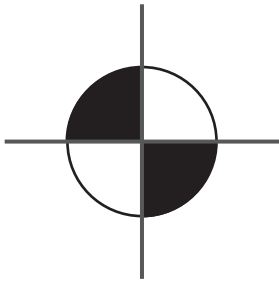

Fig. 1.20: Symbol for automatic control valve

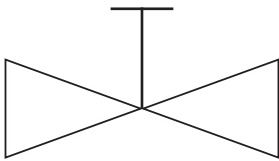

Fig. 1.21: Symbol for gate valve

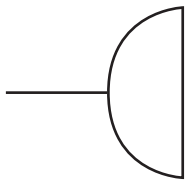

Fig. 1.22: Symbol for flush valve

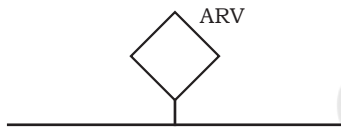

Fig. 1.23: Symbol for automatic air release valve

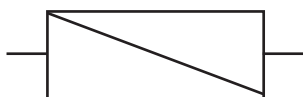

Fig. 1.24: Symbol for check valve



Fig. 1.25: Symbol for pressure reducing valve

The symbol given in Fig. 1.19 represents the head control unit.

### **Automatic control valve**

Valves allow to turn different sections on and off automatically. The symbol used to represent an automatic control valve, also known as 'solenoid', is given in Fig. 1.20.

### **Gate valve**

Gate valves may be used in place of electric valves to turn different sections on or off. They are manually operated isolation valves. The symbol used to represent a gate valve, also known as a 'hand operated valve', is given in Fig. 1.21.

### **Flush valve**

It is a self-opening valve that allows lines to be flushed when the pipe pressure is low. It shuts when the pressure builds up. The symbol used to represent a flush valve is given in Fig. 1.22.

### **Automatic air release valve**

Automatic air release valves (ARV) are used to displace air contained within an irrigation system, which can adversely affect its performance. The symbol used to represent an automatic air release valve is given in Fig. 1.23.

### **Check valve**

A check valve, also called 'non-return valve', is a mechanical device in a pipe that permits the flow of water in one direction only. It prevents the backward flow of water. The symbol used to represent a flush valve is given in Fig. 1.24.

### **Pressure reducing valve**

It is commonly used when installing a drip irrigation system or where high pressures can pose a problem. The symbol used to represent a pressure reducing valve is given in Fig. 1.25.



### **Filter**

Common types of filter include screen and graded sand filters, which remove fine material suspended in water. Filters come in different volume capacities and mesh sizes (filtration particle exclusion capacities). The symbol used to represent a filter is given in Fig. 1.26.

### **Screen filter**

It uses a fine mesh formed into a column to filter out undesirable elements from water. The symbol used to represent a screen filter is given in Fig. 1.27.

### **Mains, sub-mains and laterals**

Main lines, sub-mains and laterals supply water from the control head into the fields. They are, normally, made of flexible material, such as PVC pipes. Laterals or drip lines are small diameter (1–1.25 cm) flexible lines made of Low Density Polyethelene Pipes (LDPE). Generally, the main and sub-mains are laid across the slopes, while laterals are placed along the slopes. If a field is divided into sub-block, each block is provided with one sub-main and a control valve. Based on the available data of water capacity, water requirement of a plant and pressure required at the lateral layout, designs for the microirrigation system are made.



*Fig. 1.28: Sub-mains and laterals*

The symbol that represents the **main line**, which carries water to different sections of the irrigation system, is given in Fig. 1.29.



*Fig. 1.26: Symbol for filter*



*Fig. 1.27: Symbol for screen filter*

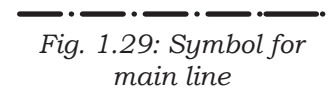

*Fig. 1.29: Symbol for main line*

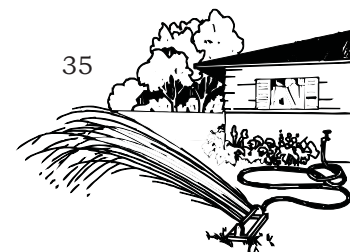

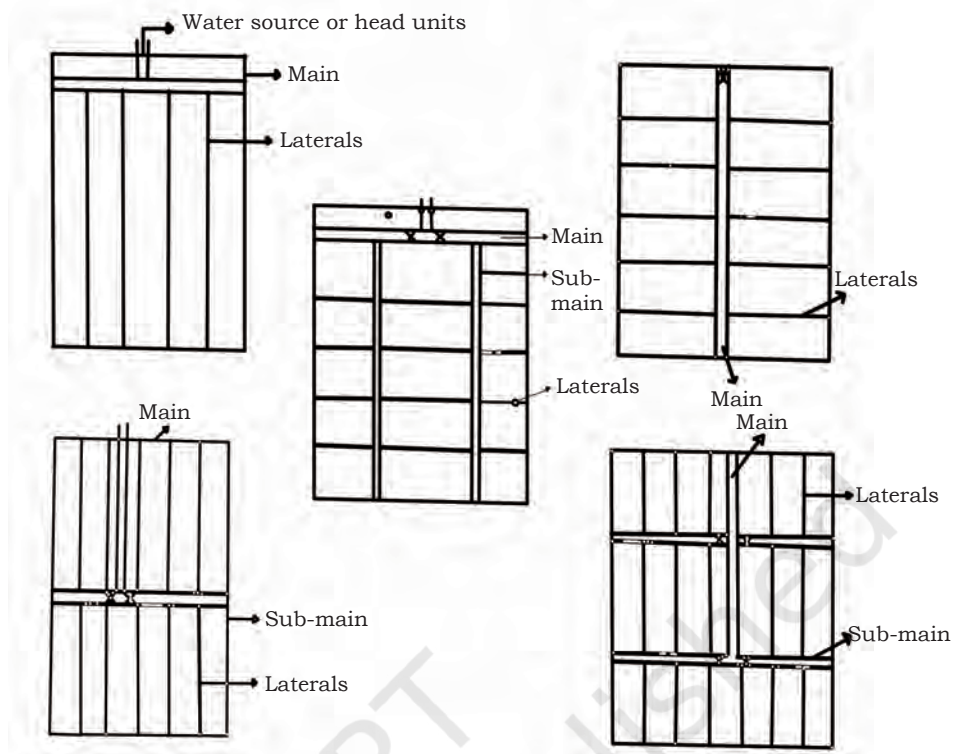

Fig. 1.30: Layout of drip irrigation system based on water source location

Fig. 1.31: Symbol for lateral lines

Laterals are, normally, laid parallel to each other. There is, usually, one lateral line for each crop row. The symbol used to represent **lateral lines** is given in Fig. 1.31.

### **Emitters or drippers**

These are fixed at regular intervals in the laterals. They are, usually, spaced more than 1 m apart. For row crops, more closely spaced emitters may be used to wet a strip of soil. They supply specified quantity of water to plants



Fig. 1.32(a): Drip online



Fig. 1.32(b): In-line emitter



in a field. Water is delivered at or near the root zones of plants, drop-by-drop. The PVC valves allow water to flow at a slow rate (2–16 litre per hour) and in various shapes and designs. Emitters are selected on the basis of soil texture and crop root zone system.

To measure the anticipated variations in the discharge of water in emitters, a pressure gauge is used. The symbol for pressure gauge is shown in Fig. 1.33.

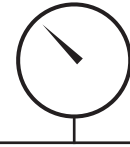

Fig. 1.33: Symbol for pressure gauge

## Design of sprinkler irrigation system

The layout of a sprinkler irrigation system will include measuring of the land and drawing its sketch to scale on a graph paper. Mark the location of hedges, shrubs, trees, and also walls and driveways on the sketch. Divide the area into zones for laying out the main lines and laterals. The next step is to determine the available water flow for the sprinkler system so as to ascertain how many sprinkler heads can run at one time. Plan the pipe layout according to the placement of risers and sprinkler heads.

Sprinkler irrigation system consists of a pump unit, main line, laterals, risers and sprinkler heads along with filter screens, desilting devices, flow regulators and fertiliser application system. It is mostly used to humidify the atmosphere, especially for young plants, sandy loam soils, greenhouses or poly-houses, and land having up and down slope. In sprinkler irrigation, water is conveyed under pressure through pipes to the area to be irrigated, where it is discharged through sprinklers.

## Components of sprinkler irrigation system

### Pump unit

A pump is used for developing the required pressure. It can be used under the following conditions.

- The land is undulating for levelling (the levelling work will be cost-intensive).
- The soil is porous, erodible and impermeable (which makes it difficult to irrigate it by any other method).
- The flow rate is too less for employing surface irrigation method.

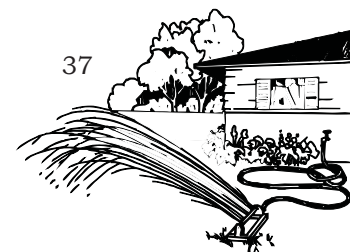

### **Filtration unit**

Filtration unit is required to remove the impurities present in the irrigation water. Hydro-cyclone, media and screen are the different types of filter. The choice of filter depends on the quality of water. If the quality of water is poor, then a filter of higher mesh size is used.

### **Pipeline**

The layout of mains, sub-mains and laterals depends on local conditions like topography, soil characteristics and source of water. The main line must be laid along the slope and the laterals across the slope or nearly on the contours. In portable system, the laterals need to be of the same size so that they can be changed easily.

### **Sprinklers**

The selection of sprinkler depends on its nozzle size and the pressure with which it discharges water. It must also be ensured that the water discharged does not cause run-off or damage to the crops. Besides, it must supply water to the crops sown in a field uniformly under the prevailing wind conditions. It must meet the irrigation water requirement of a crop and the irrigation frequency. The common symbols used when designing sprinkler irrigation plans are as follows.



Fig. 1.34: Symbol for sprinkler – full

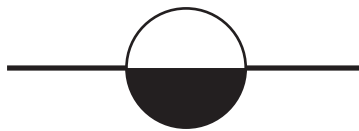

Fig. 1.35: Symbol for sprinkler – half

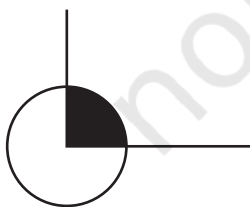

Fig. 1.36: Symbol for sprinkler – quarter

#### *Sprinkler – full*

This nozzle will, generally, throw water all around it at  $360^\circ$  and at a distance of 3.6–4.5 metre. The symbol used to represent sprinkler – full is given in Fig. 1.34.

#### *Sprinkler – half*

This nozzle will, generally, throw water all around it at  $180^\circ$  and at a distance of 3.6–4.5 metre. The symbol used to represent sprinkler – half is given in Fig. 1.35.

#### *Sprinkler – quarter*

This nozzle will, generally, throw water all around it at  $90^\circ$  and at a distance of 3.6–4.5 metre. The symbol used to represent sprinkler – quarter is given in Fig. 1.36.





### *Sprinkler – one-third*

This nozzle will, generally, throw water all around it at 120° and at a distance of 3.6–4.5 metre. The symbol used to represent sprinkler–one-third is given in Fig. 1.37.

### *Sprinkler — three quarter*

This nozzle will, generally, throw water all around it at 270° and at a distance of 3.6–4.5 metre. The symbol used to represent it is given in Fig. 1.38.

### *Sprinkler — two-third*

This nozzle will, generally, throw water all around it at 240° and at a distance of 3.6 to 4.5 metre. The symbol used to represent sprinkler–two-third is given in Fig. 1.39.



Fig. 1.40: Symbol for sprinkler – variable arc nozzle

### *Sprinkler – variable arc nozzle*

The symbol used to represent sprinkler – variable arc nozzle is given in Fig. 1.40. It represents a pop up with a variable arc nozzle, which means it can be adjusted from 0 to 360 degree. This nozzle will, generally, throw water at a distance of 3.6–4.5 metre.

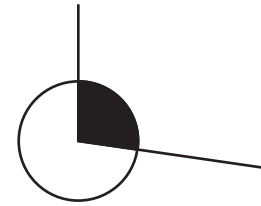

Fig. 1.37: Symbol for sprinkler – one-third

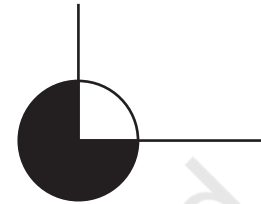

Fig. 1.38: Symbol for sprinkler – three quarter

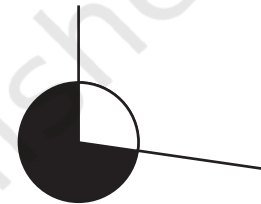
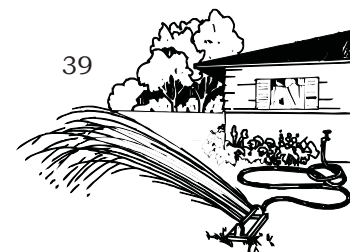

Fig. 1.39: Symbol for sprinkler – two-third

## **Units of measurement in microirrigation system**

Measurement of any physical quantity involves comparison with a certain basic, arbitrarily chosen, internationally accepted reference standard called 'unit'. The standards of measurement are useful for minimising errors. The units for fundamental or base quantities are called 'fundamental' or 'base' units. The units of all other physical quantities can be expressed as combinations of the base units. Such units obtained for the derived quantities are called 'derived units'. A complete set of these units, both the base and derived units, is known as 'system of units'.



## NOTES

These units, which are adopted for international use under the 'Système International' Unités, are now employed for all scientific and technical purposes. There are seven fundamental units — metre, kilogram, second, ampere, kelvin, candela and mole, and two supplementary units — radian and steradian. All other units are derived by the multiplication or division of these units without the use of numerical factors.

**Table 1.1: Units of measurement**

psi	Pound per square inch
kPa	Kilopascal
gal	Gallon
gpm	Gallon per minute
gph	Gallon per hour
l	Litre
lph	Litre per hour
lps	Litre per second
ml	Millilitre
ml/min	Millilitre per minute
mm/h	Millimetre per hour
cm	Centimetre
mm	Millimetre
m	Metre
m/sec	Metre per second
A	Area
in/hr	Inches per hour
ft	Feet
ft/sec	Feet per second

## Practical Exercises

### Activity 1

Visit an agricultural farm having a drip irrigation system, and study its layout and design. Note down the following:

- |                                 |                                |
|---------------------------------|--------------------------------|
| (i) Length of laterals          | (vi) Diameter of lateral       |
| (ii) Number of sub-mains        | (vii) Length of the sub-mains  |
| (iii) Diameter of the sub-mains | (viii) Number of the main line |
| (iv) Length of the main line    | (ix) Diameter of the main line |
| (v) Number of laterals          | (x) Total power of the pump    |

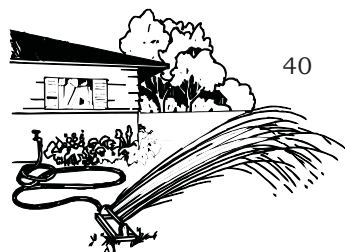

**Activity 2**

Prepare a drip irrigation layout of 200×100 m, when water source is:

- (i) at the middle of the command area
- (ii) at the corner of the command area
- (iii) around the side of the command area

**Activity 3**

Prepare a chart showing symbols for the following:

- (i) Sprinkler–full
- (ii) Sprinkler–half
- (iii) Pressure gauge
- (iv) Screen filter
- (v) Head control unit
- (vi) Flush valve

Check Your Progress

**A. Multiple Choice Questions**

1. This symbol is used to represent \_\_\_\_\_.

- (a) screen filter
- (b) filter scale
- (c) control unit
- (d) micro sprayer



2. This symbol represents \_\_\_\_\_.

- (a) main line
- (b) check valve
- (c) head control unit
- (d) filter



3. This symbol is used to represent \_\_\_\_\_.

- (a) sprinkler – half
- (b) micro sprayer
- (c) gate valve
- (d) flush valve



**B. Fill in the Blanks**

1. A typical drip irrigation system consists of a pump unit, head \_\_\_\_\_ unit, main and sub-main lines, laterals and emitters or drippers.
2. A pump is used for developing the required water \_\_\_\_\_.
3. A \_\_\_\_\_ filter uses a fine mesh formed into a column to filter out undesirable elements from the water supply.

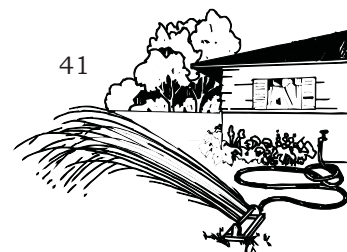

## NOTES

### C. Match the Columns

A	B
1. Sprinkler — quarter	(a) 120°
2. Sprinkler — three quarter	(b) 360°
3. Sprinkler — two-third	(c) 270°
4. Sprinkler — one-third	(d) 90°
5. Sprinkler — variable arc nozzle	(e) 240°

### D. Subjective Questions

- Write the full forms of the following.
  - psi : \_\_\_\_\_
  - lph : \_\_\_\_\_
  - lps : \_\_\_\_\_
  - gpm : \_\_\_\_\_
- Name any three type of sprinklers.
- List any three factors that affect the choice of irrigation method.
- Describe the purpose of the following components of drip irrigation system.
  - Pump
  - Main line
  - Filtration unit

### What have you learned?

#### After completing this Session, you will be able to:

- describe the basic steps that need to be followed while doing the layout and design a microirrigation system.
- identify the symbols that are used in preparing an irrigation plan.
- prepare a layout, considering the design aspects for a microirrigation system.



## Microirrigation Technician Class-11 Unit-1 Session-1

### A. Multiple Choice Questions

1. If a site is known to be windy most of the time, \_\_\_\_\_ irrigation will not be suitable.  
(a) sprinkler  
(b) drip  
(c) both (a) and (b)  
(d) None of the above
2. \_\_\_\_\_ irrigation system makes use of very low pressure.  
(a) rain gun  
(b) gravity drip  
(c) drip  
(d) sprinkler
3. The wetted soil area for widely spaced emitters in drip irrigation system will normally be \_\_\_\_\_ in shape  
(a) round  
(b) elliptical  
(c) circular  
(d) triangular
4. The sprinkler breaks up water into small droplets, usually, of 0.5 to \_\_\_\_\_ mm in size.  
(a) 3  
(b) 5  
(c) 4  
(d) 2

### B. Fill in the Blanks

1. The \_\_\_\_\_ emitters dissipate water pressure through small orifices.
2. Microirrigation helps in reducing \_\_\_\_\_ consumption, weeds, soil erosion and the total cost of cultivation.

3. A \_\_\_\_\_ irrigation system can be used on windy days and during various land operations.
4. In microirrigation system, water is applied via \_\_\_\_\_ piping system.

### C. State True or False

1. One of the major advantages of microirrigation system over surface irrigation system is that it helps reduce labour costs.
2. A microirrigation system cannot be easily automated using electrical solenoid valves and a controller.
3. Crop quality and yield under microirrigation system is improved because of irregular application of water and nutrients.

#### D. Subjective Questions

1. What are the different components of sprinkler irrigation system?
2. What are the advantages of microirrigation system?
3. Write a short note (100 words) on the following:
  - (i) Centre pivot
  - (ii) Rain gun
  - (iii) Impact sprinkler
  - (iv) Pop up sprinkler

### Microirrigation Technician Class-11 Unit-1 Session-2

#### A. Multiple Choice Questions

1. Sandy soils have \_\_\_\_\_ .
  - (a) low water storage capacity
  - (b) high infiltration rate
  - (c) more than 85 per cent sand particles by mass
  - (d) All of the above
2. Sprinkler and drip irrigation are mostly used for high-value cash crops, such as vegetables and fruits because of \_\_\_\_\_ .
  - (a) high capital investment
  - (b) low capital investment
  - (c) less requirement of water
  - (d) None of the above

#### B. Fill in the Blanks



1. A \_\_\_\_\_ soil has low water storage capacity and high infiltration rate.
2. Strong \_\_\_\_\_ can disturb the spraying of water by sprinklers.
3. Surface irrigation is preferred, if the irrigation water contains much \_\_\_\_\_.
4. Surface irrigation often requires more \_\_\_\_\_ input for construction, operation and maintenance than sprinkler or drip irrigation.
5. Surface irrigation requires accurate \_\_\_\_\_ levelling and regular maintenance.
6. Sprinkler and \_\_\_\_\_ irrigation require little land levelling as compared to surface irrigation.
7. In soils with steep or irregular slopes, high infiltration rate and scarcity of \_\_\_\_\_, sprinkler and drip irrigation may be more appropriate.

### C. State True or False

1. Strong winds cannot disturb the spraying of water from sprinklers.
2. Under strong wind conditions, drip or surface irrigation methods are not preferred.
3. Surface irrigation systems, usually, require less sophisticated equipment for both construction and maintenance.

## Microirrigation Technician Class-11 Unit-1 Session-3

### A. Multiple Choice Questions

1. This symbol is used to represent \_\_\_\_\_.  
(a) screen filter  
(b) filter scale  
(c) control unit  
(d) micro sprayer
- 
2. This symbol represents \_\_\_\_\_.  
(a) main line  
(b) check valve  
(c) head control unit  
(d) filter
- 
3. This symbol is used to represent \_\_\_\_\_.  
(a) sprinkler – half  
(b) micro sprayer  
(c) gate valve  
(d) flush valve
- 

### B. Fill in the Blanks

1. A typical drip irrigation system consists of a pump unit, head \_\_\_\_\_ unit, main and sub-main lines, laterals and emitters or drippers.
2. A pump is used for developing the required water \_\_\_\_\_.
3. A \_\_\_\_\_ filter uses a fine mesh formed into a column to filter out undesirable elements from the water supply.

### C. Match the Columns

- | A                                  | B        |
|------------------------------------|----------|
| 1. Sprinkler — quarter             | (a) 120° |
| 2. Sprinkler — three quarter       | (b) 360° |
| 3. Sprinkler — two-third           | (c) 270° |
| 4. Sprinkler — one-third           | (d) 90°  |
| 5. Sprinkler — variable arc nozzle | (e) 240° |

#### D. Subjective Questions

1. Write the full forms of the following.
  - (i) psi : \_\_\_\_\_
  - (ii) lph : \_\_\_\_\_
  - (iii) lps : \_\_\_\_\_
  - (iv) gpm : \_\_\_\_\_
2. Name any three type of sprinklers.
3. List any three factors that affect the choice of irrigation method.
4. Describe the purpose of the following components of drip irrigation system.
  - (i) Pump
  - (ii) Main line
  - (iii) Filtration unit



# Unit 2



## Installation of Sprinkler Irrigation System

A sprinkler irrigation system, which has been designed and installed as per the standard procedures and is operated within the set parameters, requires less maintenance. The block and pipe layout must be understandable from the plan. As already mentioned in Unit 1, an irrigation design plan has various symbols to indicate the positioning of pipes and other components. Usually, a key is provided with the symbols and their meanings. A table on the irrigation design plan provides information on individual irrigation blocks, including size, plant spacing, emitter delivery and application rate. The best place to start an irrigation plan is at a pump station or near the main line. The main line can be traced from the pump station. The sub-mains must be clear to the technician or the person installing the system.



171108CH02

### SESSION 1: INSTALLATION OF COMPONENTS IN SPRINKLER IRRIGATION SYSTEM

#### Checks for installation

- Find out if the design or sketch of the designated plot is ready.
- Also, see if the physical conditions of a site meet the dimensions mentioned in the plan.

- Check if all tools, material and fittings required for the installation are available.
- Find out if the trenching is ready as per design and pipe specifications.

### **Tools and equipment required for installation**

The following tools and equipment are required for the installation of a microirrigation system.

- (i) Pipe wrench (18", 24" or 36")
- (ii) Spanner set (preferably adjusting sly wrench)
- (iii) Drill machine with drill bits of different sizes
- (iv) Drill guide
- (v) Screwdriver and pliers
- (vi) Hacksaw blade with frame and one spare blade
- (vii) Measuring tape and scale
- (viii) Straight or ejecto punch
- (ix) Hand punch
- (x) S-hose pump
- (xi) Plier punch
- (xii) Take-off tool
- (xiii) Solvent cement
- (xiv) Teflon tape
- (xv) Jute
- (xvi) GI threaded joint's synthetic compound
- (xvii) Pencil or marker
- (xviii) Pressure gauge with adopter and nozzle

### **Fittings and other accessories**

Some of the important fittings and other accessories used in the installation of mains, sub-mains and sprinkler heads are as follows.

#### **Water meter**

It is used to measure the volume of water delivered. It is necessary to operate the system in order to supply the required quantity of water.

#### **Flange, coupler and nipple**

'Flange' is used to connect pipes with the use of bolted connections and gaskets. A 'coupler' is a short pipe with a socket at one or both the ends that allows two pipes



Fig. 2.1: Water meter

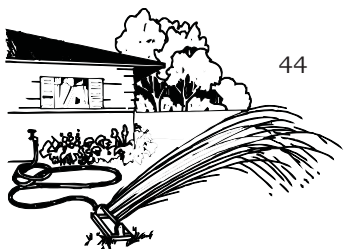

to be joined together (Fig. 2.2). 'Nipple' is a short pipe, usually, provided with a male pipe thread for connecting two other fittings on either ends.

### Pressure gauge

It is used to measure the operating pressure of the sprinkler system (Fig. 2.3). To ensure uniformity in the application of water, the sprinkler system is operated at a desired pressure.

### Lateral cock, elbow, tee, reducing joiner, ring take-off and end cap

Bends and elbows are used for changing the direction of water. The water takes a curve path while flowing through a pipe bend. Tees are T-shaped pipe fittings, having two outlets at 90 degree connected to the main line. A reducer is a component that is used to reduce the pipe size from a larger to a smaller bore. A butterfly valve is a quarter-turn rotary motion valve that is used to stop, regulate and start the flow of water. A 90 degree rotation of the handle can completely close or open the valve. An end cap is used to bend the pipe into the two holes for stopping the water flow. Goof plugs can be used to plug holes from where emitters have been removed.



Fig. 2.2: Coupler



Fig. 2.3: Pressure gauge



Fig. 2.4: Lateral cock



Fig. 2.5: Tee



Fig. 2.6: Reducing joiner



Fig. 2.7: Elbow



Fig. 2.8: Coupler ring take-off



Fig. 2.9: End cap

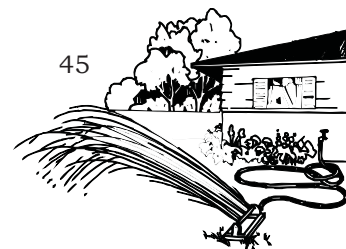

## Installing sprinkler irrigation system

The components of the sprinkler irrigation system are tested before being installed. The entire system is tested once the installation is complete. The installation work must be carried out as per the installation guidelines. Guidelines to maintain the system and few precautions starting from the installation will ensure trouble-free operation.

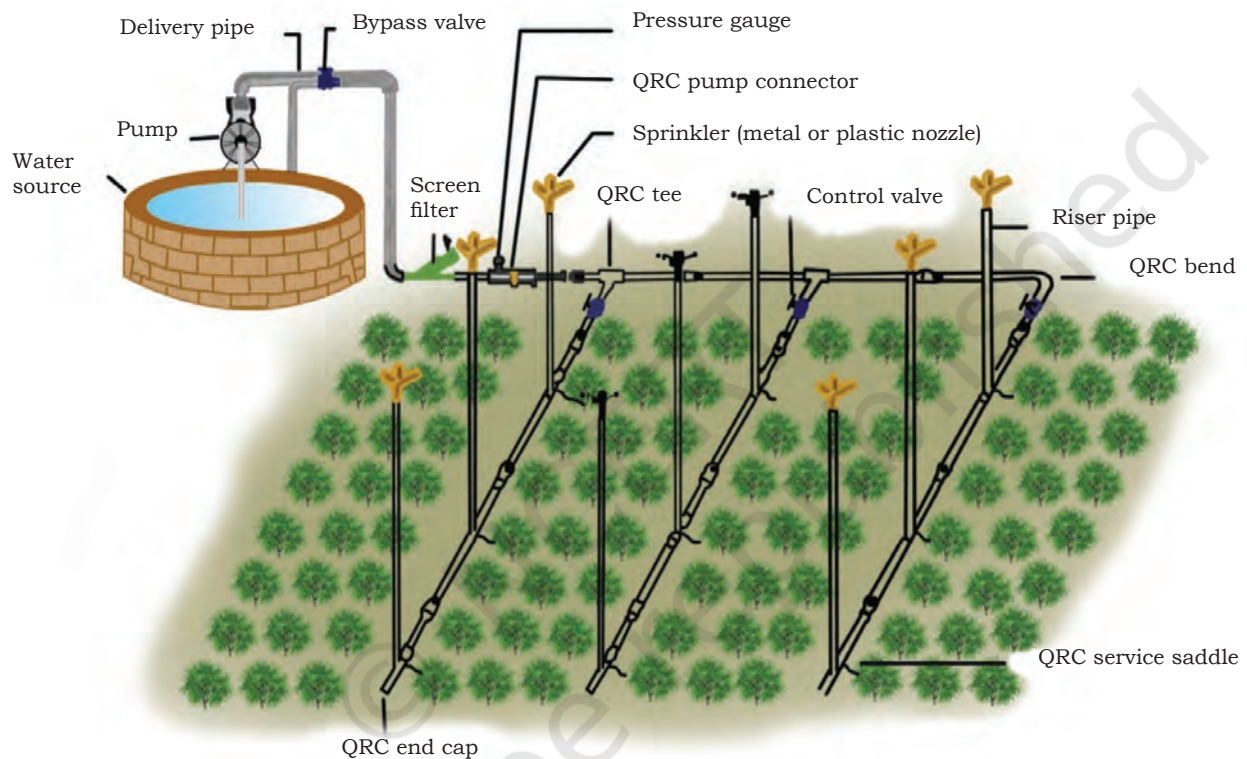
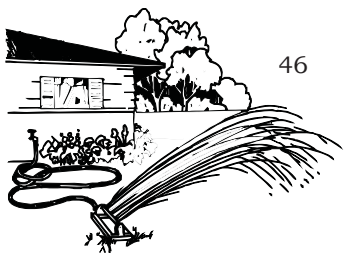

Fig. 2.10: Layout and components of sprinkler irrigation system

## Installation of head control unit

The installation of head control unit requires a cemented platform. The size of the platform depends on the various components to be installed, such as pump, bypass mechanism, non-return valve, hydrocyclone filter, fertigation unit, media filter, screen or disc filter and air release valve. A layer of paint on these fittings is used to avoid rusting. Pressure gauges are installed wherever needed to check pressure readings. Fig. 2.11 shows the various components of the head control unit.



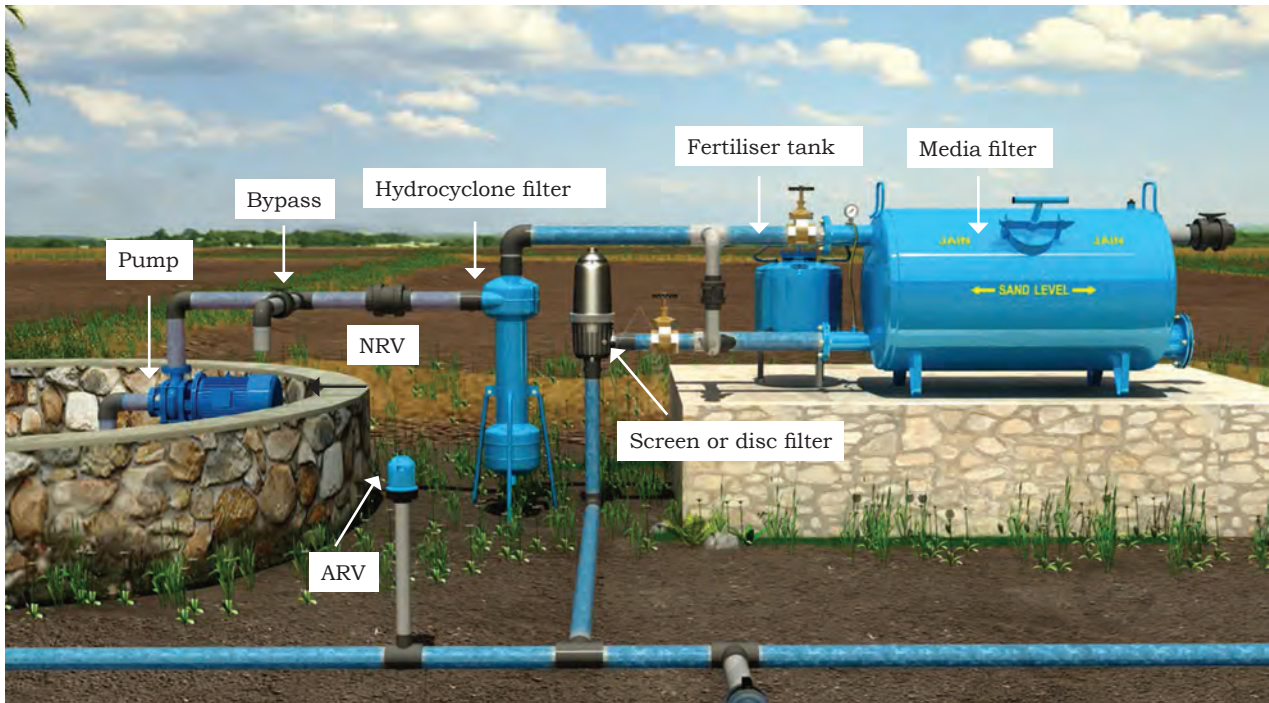

Fig. 2.11: Components of the head control unit of a microirrigation system

## Preparation of trenches

Trenches must be wide enough to allow easy handling of pipes. They must be deep enough to allow a 60-cm cover over pipes. The bottom of the trenches must be smooth and free of sharp objects, such as stones. During excavation, all large stones, which can damage the pipes, must be removed from the brink of a trench. The width of the trench must be 45–70 cm and depth 75 cm. The trenches must be dug in a straight line.

## Installation of pipes

PVC pipes must be laid according to the size and class as specified in the design. Care must be taken while laying the pipes during a hot day. Contractions due to fall in temperature may loosen the pipes.

Before joining the PVC pipes, remove burr from the edges. The outer and inner surface of the pipes must be cleaned with a sandpaper before applying solvent cement. A clean cloth must be used to clean the joining surfaces of the joints. Solvent cement must be applied evenly around the spigot end of each pipe. The spigot



Fig. 2.12: PVC pipes

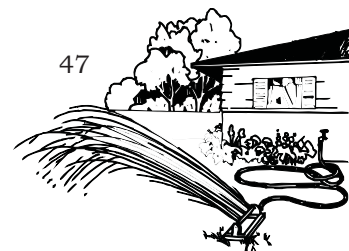

## NOTES

end of the pipes must be pushed into the sockets to the depth of entering mark. Always store the solvent cement in a cool and dry place away from fire and reach of children. Use Teflon tape to avoid leakage through the threaded ends. Avoid over tightening of these fittings by pipe wrench. Give support or fill in the trenches immediately after joining PVC pipes and fittings on curves and valves. Back filling of trenches must be done only after the testing is over. All back filling material must be free of stones as they can damage the pipes.

### Installation of valves

Air valves on the mainline must always be installed at the highest point of the pipeline or at a point of change in the slope. Control valves must be installed minimum one feet above the ground level and need to be straight, both vertically and horizontally. Use Teflon tape to wrap the threaded parts of adopters for fitting it into the valves in order to avoid leakage. Avoid over tightening by pipe wrench.

### Installation of main, sub-mains and laterals

#### **Main line**

Rigid Poly Vinyl Chloride (PVC) and High Density Polyethylene (HDPE) pipes are, normally, used as main lines to minimise corrosion and clogging. Pipes of 63 mm diameter and above with a pressure of 4–10 kg/cm<sup>2</sup> are recommended for main lines. The main line is the primary artery of a sprinkler irrigation system, usually, laid along the length of a field, which serves as a conveyance system for delivering the total amount of water to the sub-mains at the required pressure. The main line is, normally, buried about 30 cm below the soil surface and supplies water to the sub-mains.

#### **Sub-mains**

Light PVC, HDPE or Linear Low Density Polyethylene (LLDPE) pipes are used as sub-mains. Pipes having an outer diameter of 32–75 mm with a pressure of 2.5- 4.0kg/cm<sup>2</sup> are, normally, used as sub-mains. The diameter of main and sub-mains depends on the water



requirement of a crop and size of the field. Both main and sub-mains are provided with flush valves at the outlets to occasionally flush the pipes in order to remove sediments and clogging. A flow control valve (ball valve) is fitted in the beginning of each sub-main. The flush valve must not be fixed vertically but horizontally, after fixing an elbow so that the water does not spill over on to the person carrying out the work while flushing.

The sub-mains, which run perpendicular to the laterals, deliver water to the laterals. The sub-mains are connected with the main line using fittings like tee, elbow, etc., as per the installation sketch. Solvent cement must be used to ensure perfect binding at the joints.

### **Laterals**

Laterals are tubes located between the shut-off valve and sprinkler heads. The laterals are, usually, made of LDPE, Linear Low Density Polyethylene (LLDPE) or HDPE pipes of 10 to 20 mm in diameter and with a wall thickness of 1–3 mm with a pressure rating of 2.5 kg/cm<sup>2</sup>. Lateral pipes are, usually, flexible, non-corrodible, resistive to radiation and to the effects of temperature fluctuation. They are easy to install. Laterals are, usually, black in colour. The laterals supply water to a field through sprinklers. To install laterals, the following need to be done.

- (i) To connect the laterals (poly-tubes) to the sub-mains, holes are drilled on the PVC sub-main pipes using a drilling machine. The holes are drilled at a distance equal to the row spacing of the crop. The size of the holes depends on the size of the laterals and the grommet take off (GTO).
- (ii) Grommets are fixed in the holes and take-offs are fixed on the grommets. The laterals are then connected to the take-offs.

### **Sprinkler riser and head**

Sprinkler risers connect the sprinkler heads to the lateral pipes or tubes. Sprinkler heads distribute water uniformly over the field without run-off or excessive



*Fig. 2.13: HDPE pipes*

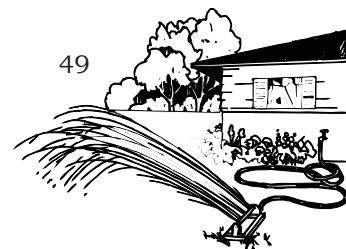

loss due to deep percolation. The most commonly used sprinklers have two nozzles, one to cover a farther area and another to cover the area near the sprinkler. The sprinkler heads are installed on riser pipes. To avoid turbulence in riser pipes, the minimum height of the riser is 300 mm for 25 mm diameter and 150 mm for 15–20 mm diameter. In general, 900-mm long GI pipe of 25 mm diameter is used.

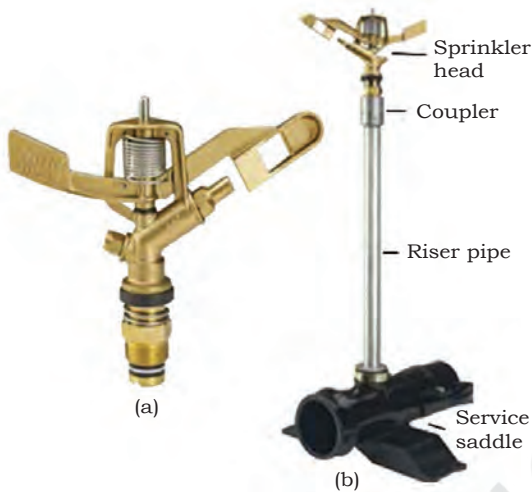

Fig. 2.14: (a) Sprinkler head  
(b) Sprinkler riser

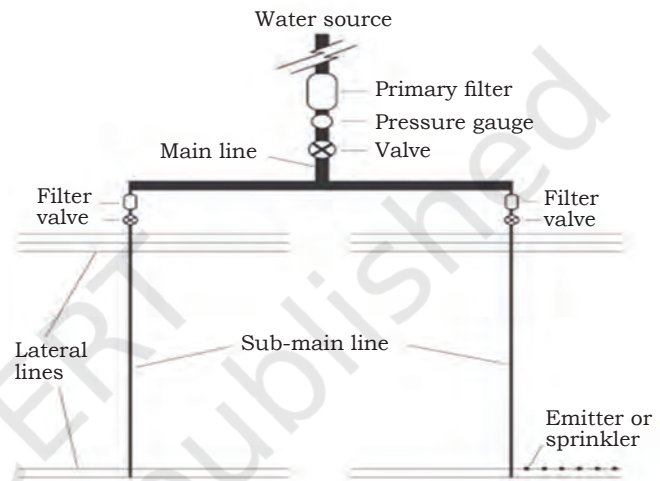
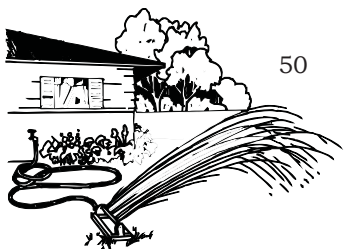

Fig. 2.15: Components of sprinkler irrigation system

The characteristics that need to be considered for sprinkler selection are jet trajectory, operating pressure and sprinkler body design. The sprinkler operating conditions to be considered in sprinkler selection are soil infiltration characteristics, desired irrigation depth, desired or appropriate irrigation cycle, crop characteristics, wind conditions and plant spacing.

The uniformity of water distribution from sprinklers depends on the pressure of water, wind velocity, rotation of sprinklers, spacing and nozzle diameter. The spacing of sprinklers in a lateral, and lateral spacing are adjusted considering all these parameters.





## Practical Exercise

### Activity

Visit an agricultural farm and study the joining or coupling of various components with pipes. Familiarise with couplers and sprinkler heads used in microirrigation system.

## Check Your Progress

### A. Multiple Choice Questions

1. The sprinkler irrigation system, usually, consists of \_\_\_\_\_.  
(a) pumping unit  
(b) mains, sub-mains and laterals  
(c) sprinkler heads  
(d) All of the above
2. A \_\_\_\_\_ is used to measure the operating pressure of the sprinkler system.  
(a) meter gauge  
(b) pressure gauge  
(c) water meter  
(d) pressure meter
3. Bends and \_\_\_\_\_ are used for changing the direction of water.  
(a) straight pipe  
(b) coupler  
(c) flange  
(d) elbow

### B. Fill in the Blanks

1. The full form of PVC is \_\_\_\_\_ Vinyl Chloride.
2. The full form of HDPE is High \_\_\_\_\_ Polyethylene.
3. The full form of LLDPE \_\_\_\_\_ Low Density Polyethylene.
4. Pipes of \_\_\_\_\_ mm diameter and above with a pressure of 4 to 10 kg/cm<sup>2</sup> are recommended for main lines.
5. Laterals ranging from \_\_\_\_\_ to 20 mm in diameter and with a wall thickness of 1–3 mm with a pressure rating of 2.5 kg/cm<sup>2</sup> are generally used.

### C. Subjective Questions

1. Write short notes on the following:
  - (i) Installation of head control unit
  - (ii) Installation of mains, sub-mains and laterals
  - (iii) Installation of sprinklers

## NOTES

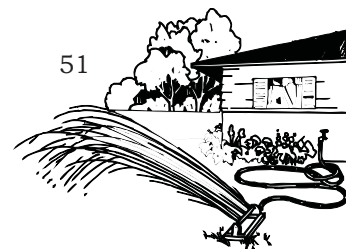

## What have you learned?

### After completing this Session, you will be able to:

- describe the functions of various components of sprinkler irrigation system.
- describe the functions of main line, sub-mains and laterals.
- describe steps for the installation of a sprinkler irrigation system.

## SESSION 2: TOOLS AND MATERIAL FOR INSTALLATION OF SPRINKLER IRRIGATION SYSTEM

A wide range of irrigation tools and equipment are available for use. Therefore, selection of an appropriate equipment or tool is essential for installing different components of a sprinkler irrigation system. The following tools, equipment and material are required for the installation of the system.



Fig. 2.16: Pipe wrench

### Pipe wrench

It is a tool used for turning soft iron pipes and fittings with a round surface for assembly or disassembly (Fig. 2.16). Its adjustable jaws allow it to lock in the frame so that any forward pressure on the handle tends to pull the jaws together. It is available in 14", 18", 24" and 36".

### Spanner set (preferably adjusting sly wrench)

It is commonly known as 'combination wrench' (Fig. 2.17). A wrench (also called spanner) is a tool used to provide grip in applying torque to turn objects.



Fig. 2.17: Spanner set



Fig. 2.18: Drill machine

### Drill machine

A drill machine is used for drilling holes in PVC pipes (Fig. 2.18). Drill bits of different sizes are used for drilling holes in PVC pipes.



## Drill guide

It is a tool that guides a drill to make a bore or hole in a PVC pipe (Fig. 2.19).

## Screwdriver

A screwdriver is a tool (manual or powered) used for turning (driving or removing from material) screws (Fig. 2.20). A typical screwdriver has a handle and a shaft, and a tip that the user inserts into the screw head to turn it. The shaft is, usually, made of tough steel to resist bending or twisting.



Fig. 2.19: Drill guide

## Pliers

It is a hand tool used to hold objects firmly with tongs (Fig. 2.21). It is also useful for bending and compressing a wide range of iron, aluminium and steel material, such as wires and sheets.



Fig. 2.20: Screwdrivers

## Hacksaw blade with frame

A hacksaw blade is a fine-toothed saw, principally, used for cutting metals (Fig. 2.22). It can also be used to cut plastic and wood.



Fig. 2.21: Pliers



Fig. 2.22: Hacksaw blade

## Measuring tape

It is a flexible ruler, consisting of a ribbon of cloth, plastic or metal strip with linear measurement markings (Fig. 2.23). It is a common measuring tool used for land measurement.



Fig. 2.23: Measuring tape

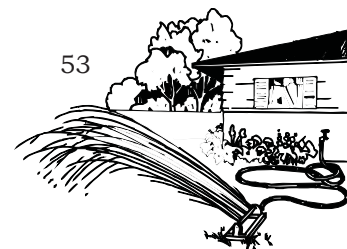



Fig. 2.24: Hose punch

### Hose punch

It is a tool used to make a hole on polyethylene tubes or laterals to install different type of emitters or drippers. The punch size varies with the size of the connector (Fig. 2.24).

### Take-off tool

It is used for dismantling and disconnecting the emitter from the lateral or poly-tube.

### Solvent cement

It is a substance that is used to bind thermoplastic pipes together by softening the surface of the material being bound.



Fig. 2.25: Teflon tape

### Teflon tape

It is a poly tetra fluoro ethylene (PTFE) film used for sealing pipe threads. The tape is sold with specific widths wound on a spool, making it easy to wind around pipe threads.

### Jute

Jute is used to wrap around the threads of pipes to make them leak-proof.

### GI threaded joint synthetic compound

It is an additive compound that prevents rusting of pipe, gives a certain grip during the installation of pipes and makes their joints leak-proof.



Fig. 2.26: Hot plate

### Pencil or marker

Pencil or marker is used to indicate a position and mark necessary details on the components or equipment for easy identification.

### Hot plate

Hot plate welding, also called 'fusion welding', is used to join plastic pipes (Fig. 2.26).



## Practical Exercise

### Activity

Visit a store selling agriculture tools, equipment and material or an institute providing training in agriculture. Familiarise yourself with the tools and equipment used in the installation and maintenance of a microirrigation system.

## Check Your Progress

### A. Fill in the Blanks

1. A \_\_\_\_\_ is a tool used for turning screws.
2. Solvent cement is a substance that is used to bind \_\_\_\_\_ sheets and pipes together.
3. A \_\_\_\_\_ is a poly tetra fluoroethylene (PTFE) film used for sealing pipe threads.
4. A \_\_\_\_\_ blade is used for cutting metals.

### B. State True or False

1. A wrench is a tool that provides grip and mechanical advantage in applying torque to turn objects, such as nuts and bolts.
2. Marker is the second most important fibre, which is used to wrap around the threads of pipes and make them leak-proof.
3. Solvent cement is a substance that is used to bind thermoplastic pipes together.

### C. Subjective Questions

1. Describe the functions of the following tools:
  - (i) Hacksaw blade
  - (ii) Wrench
  - (iii) Hot plate
  - (iv) Drill machine

## SESSION 3: CLASSIFICATION AND SUITABILITY OF PUMPS

As already discussed in the previous sessions, a microirrigation system comprises five basic units — pumping unit, control head, main line, sub-mains, laterals and emission devices.

## NOTES

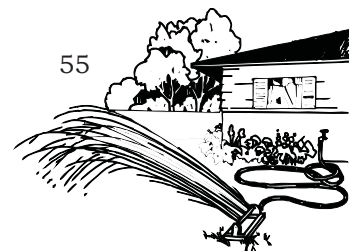

## NOTES

A pump is used for irrigation purposes. It is an electro mechanical device, which lifts water from one level to another with pressure. The pump selected must be capable of supplying water at the required pressure and discharge the same for efficient functioning of a microirrigation system. In this Session, you will learn about the types of pump used for pumping water and irrigating fields.

### Classification of pumps

A variety of pumps designed for specific applications is available in the market. Pumps can broadly be classified into two types — positive displacement and non-positive displacement pumps.

#### Positive displacement pumps

Positive displacement pumps make water move by trapping a fixed amount and forcing (displacing) that trapped volume into the discharge pipe. Pumping takes place by to and fro motion of the piston or diaphragm in the cylinder. Positive displacement pumps can be further classified on the basis of mechanical operation and working principle.

**Table 2.1: Types of positive displacement pump**

Rotary or continuous type	Reciprocating or cyclic type
Lobe pump	Piston pump
Screw pump	Bucket pump
Gear pump	Plunger pump
Vane pump	Diaphragm pump
Radial plunger pump	Petro pump
	Semi-rotary pump
	Gas or vapour displacement

#### ***On the basis of mechanical operation***

On the basis of mechanical operation, positive displacement pumps are of three types — piston, diaphragm and plunger pumps.



### *Piston pump*

In 'piston pump', the high-pressure seal reciprocates with the piston. The pump has a piston cylinder arrangement. As the piston goes away after the delivery stroke, low pressure is created in the cylinder, which opens the suction valve. On forward stroke, the water trapped inside the cylinder is compressed, which in turn opens the delivery valve.

### *Diaphragm pump*

This pump uses a combination of reciprocating action of a rubber, thermoplastic or Teflon diaphragm, and non-return check valves to pump water.

### *Plunger pump*

A 'plunger pump' is one, in which there is a high-pressure stationary seal and a smooth cylindrical plunger, which slides through the seal.

## **On the basis of the working principle**

### *Rotary or continuous pumps*

Rotary or continuous pumps move water using the 'principle of rotation'. The vacuum created by the rotation of the pump captures and draws in the water. These pumps are capable of pumping more water than reciprocating pump. The different types of rotary or continuous pump are as follows.

**Lobe pump:** It works like gear pump, except that the lobes do not come in contact with each other. Lobe pump has larger chambers than gear pump. The water flows into the cavity of the pump and is trapped by the lobes as they rotate. The water travels around the interior of the casing in the pockets between the lobes and the casing. Finally, the meshing of the lobes forces the water through the outlet port under pressure.

**Screw pump:** It is type of rotary pump, featuring two or three screws with an opposing thread, i.e., one screw turns clockwise and the other anti-clockwise. In screw pump, water is pumped by means of screw

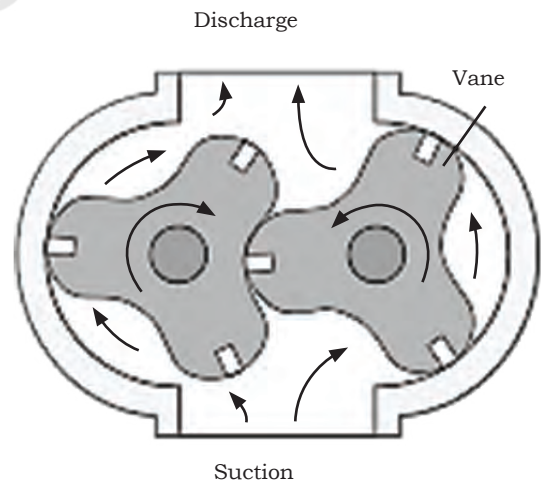
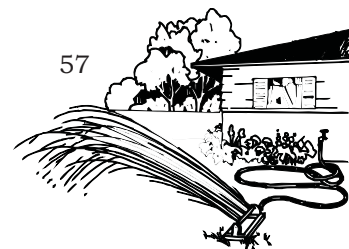

Fig. 2.27: Lobe pump



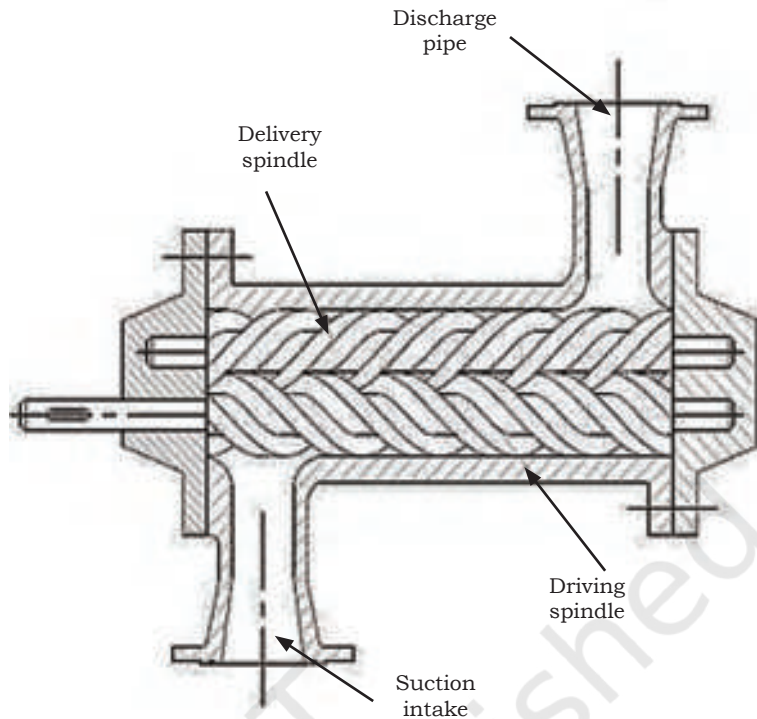

Fig. 2.28: Screw pump

operation (single-screw pump or several screws being in engagement). The performance capacity of single-screw pump can be calculated in the following way.

$$Q = 4 \cdot e \cdot D \cdot T \cdot n \cdot \eta_v$$

Q: screw pump performance capacity,  $\text{m}^3/\text{s}$

e: eccentricity, m

D: diameter of rotor screw, m

T: pitch of stat or screw surface, m

n: rotor rotation speed,  $\text{ms}^{-1}$

$\eta_v$ : volumetric efficiency

**Gear pump:** It is the simplest type of rotary pump, consisting of two gear laid in a manner that their teeth are enmeshed for smooth rotation. The pump moves water by repeatedly enclosing a fixed volume using interlocking gear and transferring it mechanically by cyclic pumping action. Gear pump performance capacity can be calculated in the following way.

$$Q = 2 \cdot f \cdot z \cdot n \cdot b \cdot \eta_v$$

Q: gear pump performance capacity,  $\text{m}^3/\text{s}$

f: cross-sectional area of space between adjacent gear teeth,  $\text{m}^2$

z: number of gear teeth

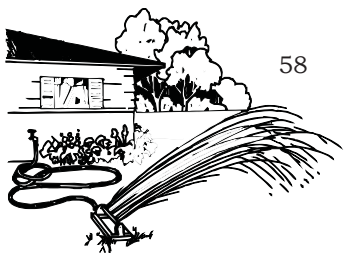



b: gear tooth length, m  
 n: teeth rotation speed, s<sup>-1</sup>  
 $\eta_{v\cdot}$ : volumetric efficiency

There is also an alternative formula for calculating the gear pump performance capacity.

$$Q = 2 \cdot \pi \cdot D_H \cdot m \cdot b \cdot n \cdot \eta_{v\cdot}$$

Q: gear pump performance capacity, m<sup>3</sup>/s

D<sub>H</sub>: gear pitch diameter, m

m: pitch of a gear, m

b: gear width, m

n: gear rotation speed, s<sup>-1</sup>

$\eta_{v\cdot}$ : volumetric efficiency

**Vane pump:** It consists of vanes mounted on a rotor that rotates inside a cavity. Vanes are allowed to slide into and out of the rotor and seal on all edges, creating vane chambers that do the pumping work. Vane pumps are self-priming, robust and supply constant delivery at a given speed. They provide uniform discharge with negligible pulsations. These pumps do not require check valves.

**Radial plunger pump:** A radial plunger pump is a form of hydraulic pump. The working pistons extend in a radial direction symmetrically around the drive shaft. These are made up of valve controlled pump cylinders arranged in radial star shape.

### *Reciprocating or cyclic pumps*

Reciprocating or cyclic pumps operate by drawing liquid into a chamber or cylinder by the action of a piston, plunger or diaphragm. The water is discharged in the required direction by the use of check valves. This results in pulsed flow.

**Piston pump:** As the piston goes down, the check valve in the pump

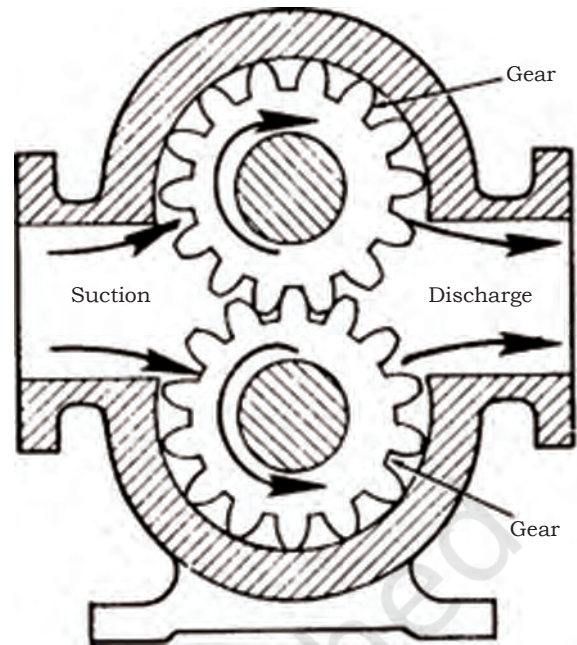

Fig. 2.29: Gear pump

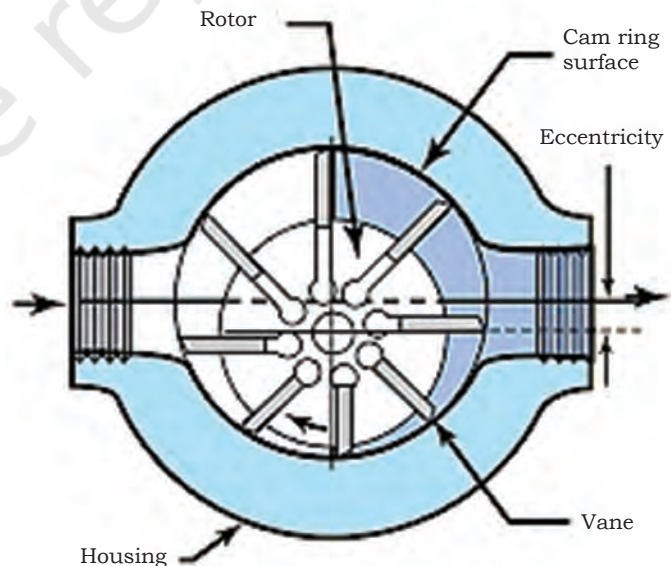
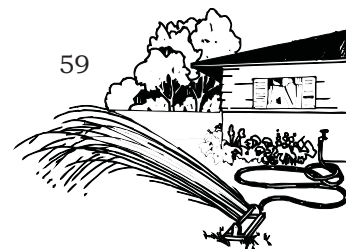

Fig. 2.30: Vane pump



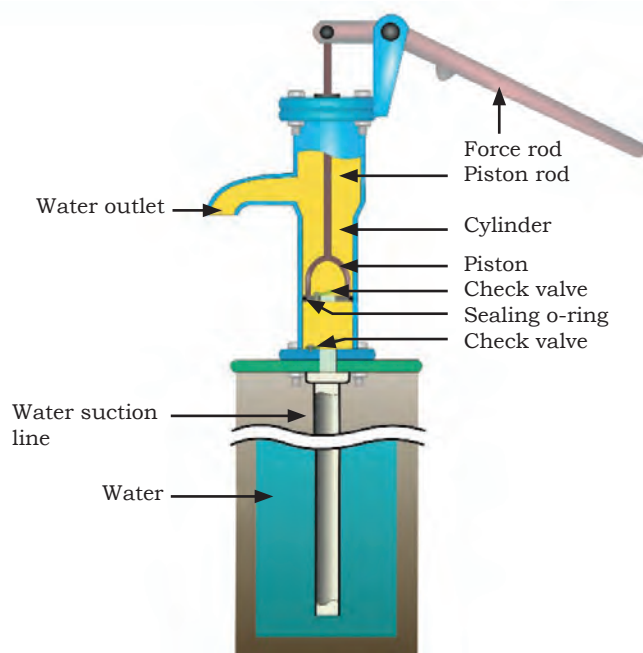

Fig. 2.31: Hand pump

opens, thereby, allowing the water to pass through. The check valve at the base of the cylinder remains closed, holding the water in the cylinder. As the piston moves up, the check valve in it closes, allowing the water above the piston to be lifted. The rising piston pulls up the water into the cylinder. This down and up motion of the piston enables the water to move up and out of the pump. Hand pump is an example of piston pump.

**Bucket pump:** It has a series of buckets attached to a chain or rope, which collects and lifts water, and dumps it into the spout as the handle at the top is turned.

### Non-positive displacement pumps

In non-positive displacement pumps, water is pressurised by the rotation of propeller and the water pressure is proportional to the speed of the rotor. These pumps provide smooth and continuous flow of water.

#### **Centrifugal pump**

It operates when water is drawn into the central chamber of a spinning impeller. It is, then, engaged by the vanes that drive the water outside the pump volute casing. This process transforms the kinetic energy of the impeller into the pressure head used to discharge water from sprinklers or emitters located in the area to be irrigated. One of the limitations of centrifugal pump is that before starting, the impeller casing and intake (suction) pipe must be filled with water. This process is called 'priming'. It is necessary as differential pressure needed to draw water into the pump will be created when the pump is turned 'on'. As the water flows from the impeller into the delivery system, an area of low pressure is created at the impeller centre. This draws a continuous stream



Fig. 2.32: Centrifugal pump



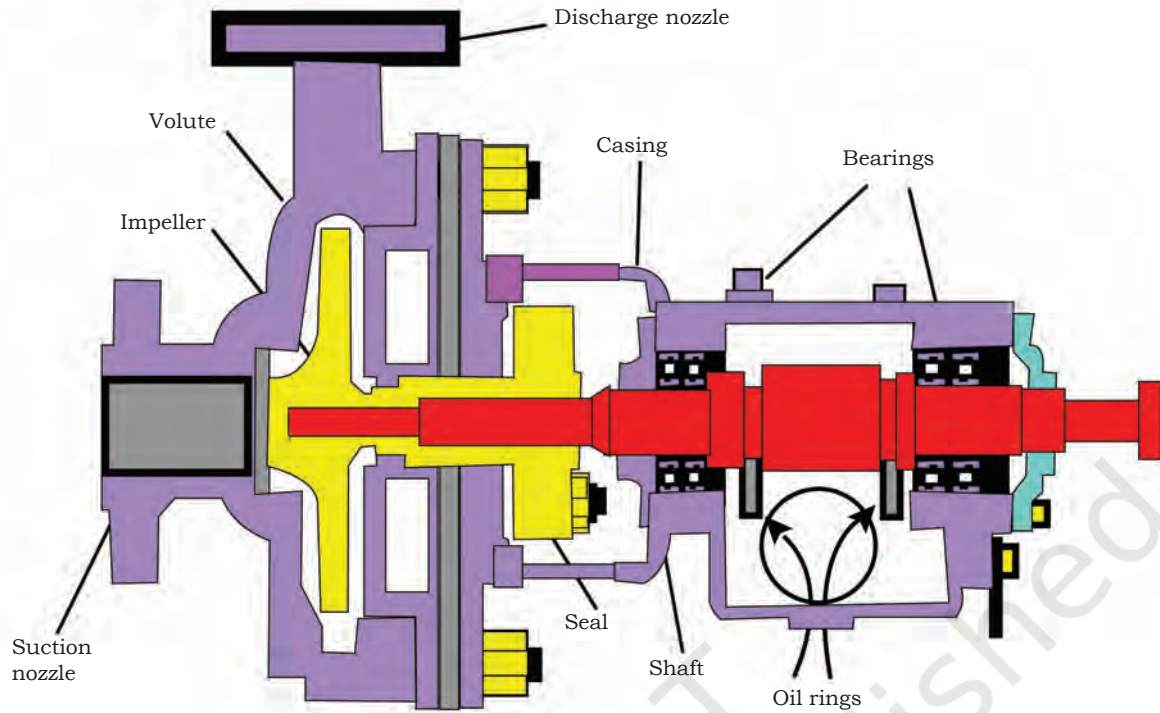

Fig. 2.33: Cross-sectional view of centrifugal pump

of water from the source into the impeller. Centrifugal pump performance capacity can be calculated in the following way.

$$Q = b_1 \cdot (\pi \cdot D_1 - \delta \cdot Z) \cdot c_1 = b_2 \cdot (\pi \cdot D_2 - \delta \cdot Z) \cdot c_2$$

Q: centrifugal pump performance capacity, m<sup>3</sup>/s

b<sub>1,2</sub>: widths of impeller pass through diameters D<sub>1</sub> and D<sub>2</sub>, m

D<sub>1,2</sub>: inlet external diameter (1) and impeller external diameter (2), m

δ: thickness of blades, m

Z: number of blades

C<sub>1,2</sub>: radial components of absolute velocities at impeller inlet (1) and its outlet (2), m/s

#### *Installation of centrifugal pump*

Guidelines, as regards to standards for electrical connections, foundation for installing the pump, number of bends on delivery, suction side and shelter to protect the pump in different weather conditions must be followed while installing and operating the centrifugal pump.

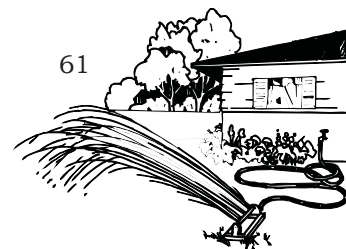

## NOTES

A centrifugal pump is installed close to a water source. It must be located at an accessible place in a clean, dry and ventilated area. To ensure the maximum utilisation of the pump's capacity, the site selected must permit the use of shortest and most direct suction and discharge pipes. The pump is installed on a concrete foundation, so that it can tolerate vibrations. It must have minimum plumbing fittings so as to avoid friction losses. The use of bends, elbows, tees and other fittings must be kept to minimum in order to reduce head loss in the discharge line. The current carrying capacity of wires used in pump installation needs to be sufficient to avoid excess heating of wires and hazards like fire.

### *Operation of centrifugal pump*

If one is starting the pump for the first time, attention must be paid to the following.

- (i) Check the alignment of the pump. Any misalignment is to be corrected by placing shims under the pump or driver.
- (ii) Make sure that the engine or motor drives the pump in the direction indicated on the pump body.
- (iii) It must be ensured that the gland is tightly and evenly adjusted, and the pump shaft revolves freely when turned by hand.
- (iv) Check for air tightness of the suction pipe and leakage in the foot valve.
- (v) Fill the suction line and pump with water and remove air from the pump casing.
- (vi) Attend to lubrication requirements.

### *Submersible pump*

It is a kind of centrifugal turbine pump, wherein long vertical shaft, connecting the motor and pump unit, is replaced by a short shaft. The prime mover and pump become closely coupled and submerged in water. Submersible pumps are suitable for tube wells with a bore of 100 mm or more. The impeller of the pump may be closed, semi-open or open. The principle advantage of submersible pump is that it can be used in a deep tube well, where using a long shaft would not be practical.



## Solar-powered pump

A solar-powered pump runs on electricity generated by photo voltaic panels, which collect thermal energy. It is later converted into electrical energy for pump operation. Generally, a 5 HP (horsepower) AC (alternating current) solar pump sets with 4800 wp capacity must be used for lifting water from an open well or other surface storage structure.



Fig. 2.34: Solar-powered pump

## Suitability of pump

Suction and lift are the factors that must be considered when pumping water. 'Suction' is the vertical distance between the water to be pumped and the centre of the pump, while 'lift' is the vertical distance between the pump and the delivery point like emitters and sprinklers. For example, the depth from which a hand pump will draw water is limited by atmospheric pressure to an operating depth of less than 7 metre. The size of the motor will depend on the depth of the well or water body (head or lift) and the volume of water to be moved by the pump.

Pumps develop differential head or differential pressure. This means the pumps take suction pressure, add more pressure (design pressure) and generate discharge pressure. So, the discharge pressure is equal to the suction pressure plus the pumps' design pressure. Discharge pressure is determined on the basis of desired operating pressure, loss of pressure due to friction and change in elevation within the field.

While selecting a pump, one must take into consideration the maximum total head against which it is expected to operate and deliver the required discharge. This is determined by:

$$H_t = H_n + H_m \pm H_j + H_s, \text{ where}$$

$H_t$  = total design head against which the pump is working, m

$H_n$  = maximum head required at the main to operate the sprinklers on the lateral at the required average pressure, including the riser height, m

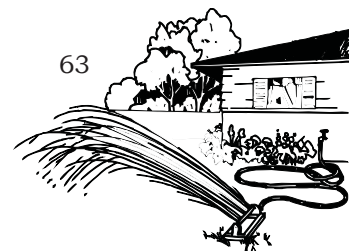

$H_m$  = maximum friction loss in the main and suction line, m

$H_j$  = elevation difference between the pump and the junction of the lateral and the main, m, and

$H_s$  = elevation difference between the pump and the source of water after draw down, m

The discharge required to be delivered by the pump is determined by multiplying the number of sprinklers that are operated at a given point of time by the discharge of each sprinkler. Once the head and discharge of the pumps are known, the pump may be selected from rating curves or tables provided by the manufacturer.

### Determination of total head

The total pressure head or dynamic head required for the normal operation of the system is the sum of the following heads.

Total head loss (H) = Suction + delivery (m) + filter losses + fitting losses + ventury head loss + operation losses + lateral + sub-main losses + main line losses

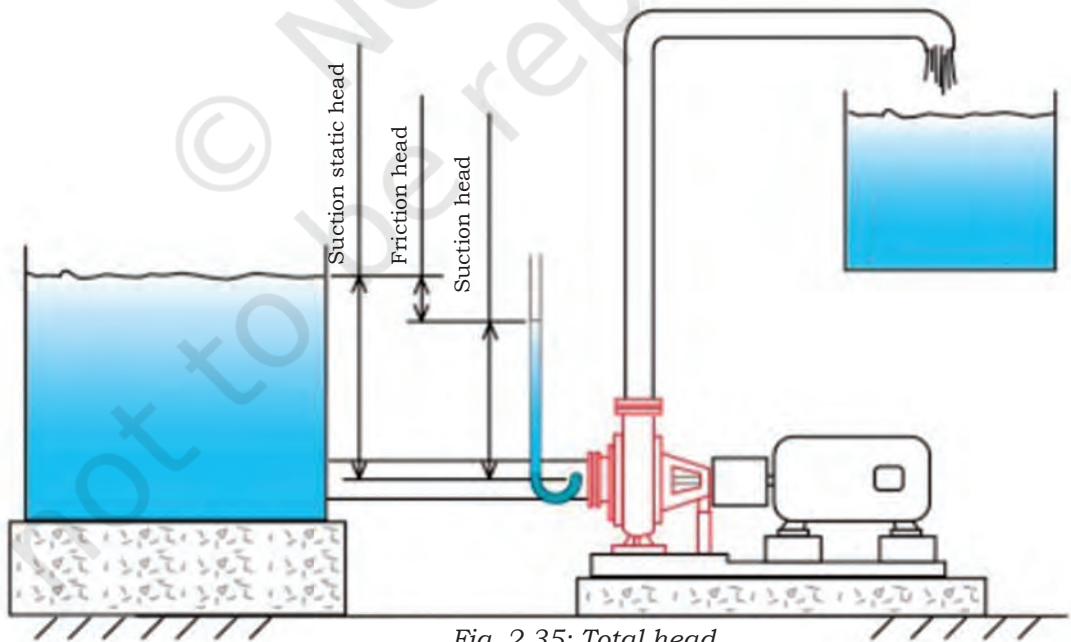
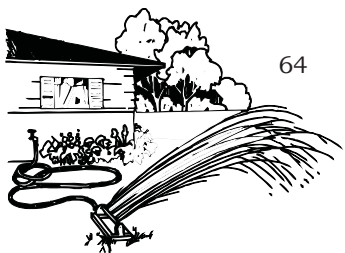

Fig. 2.35: Total head

source: [www.pumpfundamentals.com](http://www.pumpfundamentals.com)



## Determining horsepower of pump

This is the sum of the system's total head plus the pumping lift. The brake horsepower formula is:

$$\text{HP} = \frac{Q \times H}{75 \times a \times b}$$

Where,

Q: is the flow capacity in litres per hour

H: is the total head expressed in metres

a: is the pump efficiency

b: is the driving efficiency

- Pump efficiency: 0.5–0.8
- Electric motor efficiency: 0.7–0.9

### Example

Main line flow (lps): 4.98

Total head loss (H) = Suction + delivery (10 m) + filter losses (5m) + fitting losses (2 m) + ventury head loss (5 m) + operation losses (10 m) + lateral + sub-main losses 1.6+0.8 (2.4) + main line losses = 1.65 m

Total head loss (H) = 10 + 5 + 2 + 5 + 10 + 2.4 + 1.65  
= 36.5 m

$$= \frac{\text{HP} = Q \times H}{75 \times a \times b}$$

$$= \frac{4.98 \times 36.5}{75 \times 0.8 \times 0.85}$$

$$= 3.56 = 5 \text{ HP}$$

The required pump size is 5 HP.

## Practical Exercises

### Activity 1

Draw a diagram of a cross-sectional view of centrifugal pump and label the parts.

### Activity 2

Visit an agricultural farm and study the type of pumps installed for irrigation.

### Activity 3

Read the manual for the installation and maintenance of a centrifugal pump.

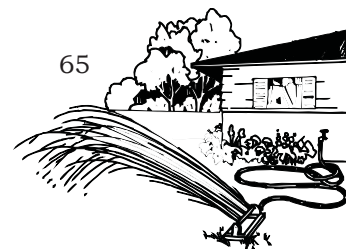

### Check Your Progress

#### A. Fill in the Blanks

1. In piston pump, the high-pressure seal reciprocates with the \_\_\_\_\_.
2. Pump is an \_\_\_\_\_ device, which lifts water from one level to another with pressure.
3. A pump can be driven by an \_\_\_\_\_ motor or an internal combustion engine.
4. Any misalignment in a centrifugal pump is to be corrected by placing \_\_\_\_\_ under the pump or driver.
5. A radial plunger pump is a type of \_\_\_\_\_ pump.

#### B. State True or False

1. The main operating component of piston pump is the cylinder, in which the piston does not move.
2. Hand pump is an example of piston pump.
3. Submersible pump is a type of centrifugal turbine pump.

### What have you learned?

#### After completing this Session, you will be able to:

- differentiate between various types of positive displacement pump and their uses.
- differentiate between various types of non-positive displacement pump and their uses.
- determine the suitability of a pump for a microirrigation system.





## Microirrigation Technician Class-11 Unit-2 Session-1

### A. Multiple Choice Questions

1. The sprinkler irrigation system, usually, consists of \_\_\_\_\_.  
(a) pumping unit  
(b) mains, sub-mains and laterals  
(c) sprinkler heads  
(d) All of the above
2. A \_\_\_\_\_ is used to measure the operating pressure of the sprinkler system.  
(a) meter gauge  
(b) pressure gauge  
(c) water meter  
(d) pressure meter
3. Bends and \_\_\_\_\_ are used for changing the direction of water.  
(a) straight pipe  
(b) coupler  
(c) flange  
(d) elbow

### B. Fill in the Blanks

1. The full form of PVC is \_\_\_\_\_ Vinyl Chloride.
2. The full form of HDPE is High \_\_\_\_\_ Polyethylene.
3. The full form of LLDPE \_\_\_\_\_ Low Density Polyethylene.
4. Pipes of \_\_\_\_\_ mm diameter and above with a pressure of 4 to 10 kg/cm<sup>2</sup> are recommended for main lines.
5. Laterals ranging from \_\_\_\_\_ to 20 mm in diameter and with a wall thickness of 1-3 mm with a pressure rating of 2.5 kg/cm<sup>2</sup> are generally used.

### C. Subjective Questions

1. Write short notes on the following:
  - (i) Installation of head control unit
  - (ii) Installation of mains, sub-mains and laterals
  - (iii) Installation of sprinklers

## Microirrigation Technician Class-11 Unit-2 Session-2

### A. Fill in the Blanks

1. A \_\_\_\_\_ is a tool used for turning screws.
2. Solvent cement is a substance that is used to bind \_\_\_\_\_ sheets and pipes together.
3. A \_\_\_\_\_ is a poly tetra fluoroethylene (PTFE) film used for sealing pipe threads.
4. A \_\_\_\_\_ blade is used for cutting metals.

### B. State True or False

1. A wrench is a tool that provides grip and mechanical advantage in applying torque to turn objects, such as nuts and bolts.
2. Marker is the second most important fibre, which is used to wrap around the threads of pipes and make them leak-proof.
3. Solvent cement is a substance that is used to bind thermoplastic pipes together.

### C. Subjective Questions

1. Describe the functions of the following tools:
  - (i) Hacksaw blade
  - (ii) Wrench
  - (iii) Hot plate
  - (iv) Drill machine

## Microirrigation Technician Class-11 Unit-2 Session-3

### A. Fill in the Blanks

1. In piston pump, the high-pressure seal reciprocates with the \_\_\_\_\_.
2. Pump is an \_\_\_\_\_ device, which lifts water from one level to another with pressure.
3. A pump can be driven by an \_\_\_\_\_ motor or an internal combustion engine.
4. Any misalignment in a centrifugal pump is to be corrected by placing \_\_\_\_\_ under the pump or driver.
5. A radial plunger pump is a type of \_\_\_\_\_ pump.

### B. State True or False

1. The main operating component of piston pump is the cylinder, in which the piston does not move.
2. Hand pump is an example of piston pump.
3. Submersible pump is a type of centrifugal turbine pump.

# Unit



## Operation and Maintenance of Microirrigation System

### SESSION 1: OPERATION AND MONITORING OF SPRINKLER IRRIGATION SYSTEM

A sprinkler irrigation system must be operated keeping with the recommended irrigation practice. It must be ensured that the prime mover and pump are in alignment, particularly, in case of tractor-driven pumps. Service and installation procedures with respect to pump and power units must be observed. While starting the sprinkler system, the motor or engine is started with the valves closed. The pump must attain the pressure stated on the type-plate, else there is a fault in the suction line. After the pump reaches the regulation pressure, the delivery valve is opened slowly. Similarly, the delivery valve is closed after stopping the power unit. The pipes and sprinkler lines are shifted as required after stopping, in case of portable sprinkler system. The following steps need to be followed for operating the sprinkler system.

- (i) Start the pump and open the valve to fill the pipes with water.
- (ii) Release all end caps and flush valves to clean the system of dirt and clogging. Before operating the system, the end caps installed at the end of the laterals and sub-mains are released so that dirt in the pipes is washed away and air is also driven



171108CH03

out. Open the control valve and let the water flow freely through the pipes for some time. Then, close the end caps and ensure that water comes out from each sprinkler.

- (iii) Check the pressure and discharge of water, and ensure that all sprinklers are operational.
- (iv) Operate the system according to the recommended irrigation schedule.

### **Operation and efficiency of sprinklers**

The two main types of spray head installation are risers and pop-ups. Both the types are available in different spray patterns, including full-circle, half-circle, quarter-circle and fully adjustable. These spray head nozzles are made to deliver matched precipitation rates, meaning that a quarter circle pattern will deliver one-fourth as much water as a full circle. Each sprinkler delivers a metered amount of water over a part of the entire zone. It is essential that each zone has the same type of sprinkler heads as each type has a specific rate of application. If different types of sprinkler head are placed on the same lateral, the distribution will be uneven, leading to the emergence of dry or wet spots.

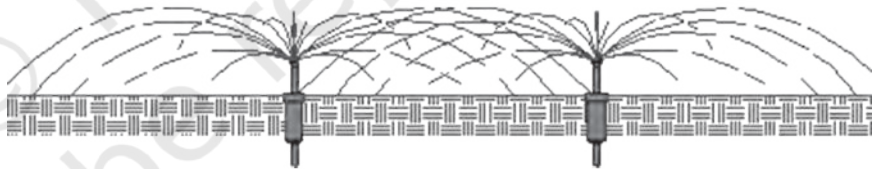

*Fig. 3.1: Schematic sketch of overlapping sprinkler sprays*

The operation and efficiency of sprinklers depend on the degree of uniformity of water application, which depends on the water spray distribution characteristics of sprinkler nozzles and sprinkler spacing. The sprinklers are installed in a manner that they overlap the watered area. This overlap may seem like a waste, but it is a necessity.

The spray distribution characteristics change with the nozzle size of a sprinkler and its operating pressure. At lower pressure, the drops are larger and water from the nozzle falls in a ring away from the sprinkler. For

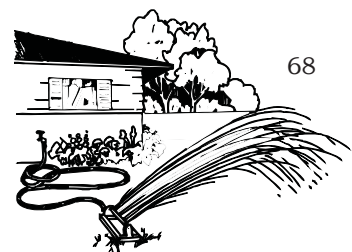

higher pressure, the water from the nozzle breaks into fine droplets, which fall close to the sprinkler. Almost all sprinklers have an in-built radius adjustment device in order to reduce the radius of the water throw.

Operating a sprinkler at pressures above the design range results in excessive misting (small droplet size) and water is easily blown away or evaporated or may accumulate close to the sprinkler. The actual spacing, however, shall be guided by the size of pipes available in market. Generally, pipes of 6 m (full size) and 3 m (half size) are available.



Fig. 3.2: Overlapping sprinkler sprays in a farm

### Maintenance of sprinklers

- Do not apply oil, grease or any other lubricant on to the sprinklers. They are water lubricated and using oil, grease or any other lubricant may make them defunct.
- Sprinklers, usually, have a sealed bearing and at the bottom of the bearing there are washers. Usually, it is the washers that get damaged and not the metal parts. The washers are to be checked for wear and tear. Replace the damaged washers.
- After several operations, the swing arm spring of the sprinkler may need tightening. This is done by pulling out the spring end at the top and bending it again. This will increase the spring tension.
- Check all equipment at the end of the season and make necessary repairs and replacements so that the equipment is ready for the next season.

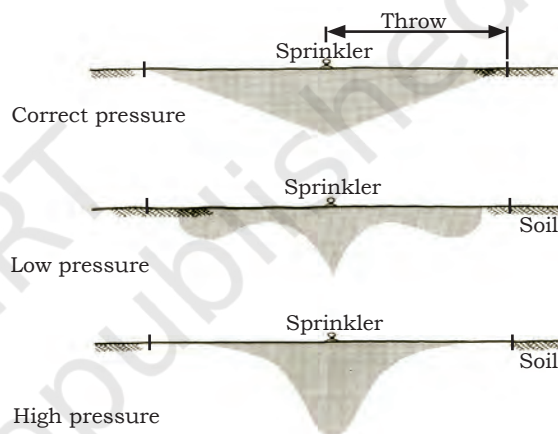

Fig. 3.3: Effect of variation in water pressure on sprinkler spray pattern

## Practical Exercises

### Activity 1

Visit a farm, where a sprinkler irrigation system is installed and study the following.

- Distance between sprinkler heads

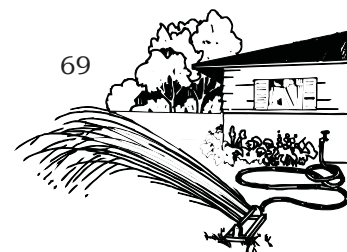

## NOTES

- (ii) Types of sprinkler head
  - (iii) Wetted area around sprinkler head
- Prepare a note based on your observations.

### Activity 2

Visit a farm, where a sprinkler irrigation system is installed and study the following.

- (i) Uniformity of water application
  - (ii) Maintenance schedule
  - (iii) Number of sprinklers functional and non-functional
- Prepare a note based on your observations.

## Check Your Progress

### A. Fill in the Blanks

1. Each sprinkler delivers a \_\_\_\_\_ amount of water over a part of the entire zone.
2. The two main types of spray head installation are \_\_\_\_\_ and pop-ups.
3. Sprinklers are designed to \_\_\_\_\_ the watered areas.
4. Do not apply \_\_\_\_\_, grease or any other lubricant on to the sprinklers. They are water lubricated and using oil, grease or any other lubricant may stop them from working.

### B. Subjective Questions

1. Describe the operation of sprinklers.
2. Write a note on the maintenance of sprinklers.

## What have you learned?

### After completing this Session, you will be able to:

- describe the factors that influence the operation and functioning of a sprinkler system.

## SESSION 2: MAINTENANCE OF SPRINKLER IRRIGATION SYSTEM

At the beginning of each growing season, check the irrigation line from the valve to the spray heads for leaks. Take a round of the entire field and check if there is leakage at joints or damage to any component of the system. Rectify the defects, if any, by replacing the spare parts. Remove folds or kinks on laterals or pipes, and make them straight.



Clean the irrigation system periodically to remove dirt and debris that have built up over time. There are few basic steps that one must take at least once in a year to ensure that water always gets through the system. Using a filter can prevent build-up of minerals and organic particles in pipes, risers and nozzles, and make it easy for cleaning. It is also important to follow these instructions in order to flush each zone in the system at least once a year.

- (i) Turn off water supply to one zone, and remove nozzles and sprinkler heads.
- (ii) Run water through the zone for few minutes until the filter is clean and a clear stream of water flows from each sprinkler.
- (iii) Take apart the nozzles (depending on the type, you can do this by hand or with a screwdriver or special key).
- (iv) Clean the nozzles to remove dirt or deposits.
- (v) Rinse the filter screen or basket.
- (vi) Reassemble the filter and replace the damaged or worn out parts.
- (vii) Turn on the zone again to check that everything is leak-proof and operational.

**Table 3.1: Maintenance schedule for sprinkler irrigation system**

Frequency	Action	
Daily	Pressures	Check that pump and block pressures are within the prescribed limits.
	Emitter operation	Check for clogged, broken or misplaced emitters. Repair, replace, unclog or reposition the emitters.
	Leaks	Check for water wastage and leaks in pipes and other equipment, and repair them immediately.
	Primary filter	Flush primary filters as prescribed.
	Fertigation application	Check that fertigation applications are within specifications.

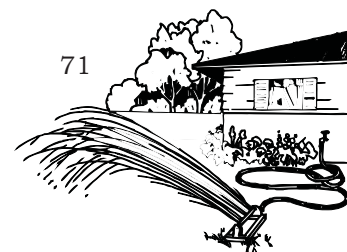



## NOTES

Weekly	Lateral lines	Flush the lateral lines as prescribed.
	Exposed joints	Check and repair them if needed, e.g., quick coupling rubbers.
	Secondary filters	Flush the secondary filters as prescribed.
	System pressure and flow	Check that the system pressure and flow are as per the irrigation design plan.
	Pump operation	Check that pump operation is within the prescribed parameters.
	Block pressures for automated valves	Check that the block pressures are within the prescribed limits where automated valves are used.
	Pump oil levels	Check pump oil levels as prescribed.
	Fertigation plant	Inspect the fertigation plant.
	Pipes	Check for leaks and repair them.
Monthly	Valves, water meter and gauges	Visually check the valves, water meter and gauges, and look for damage and vandalism.
	Filters	Open and inspect the filters as prescribed.
	Pump pipe work	Check for leaks at the pump station that causes water losses and airlocks.
	Pump motor	The pump motor must be greased as prescribed.
Annually	Valves	Check the service valves and replace them, if required.
	Filters	Clean the filters and replace them annually or in two years.
	Pump	Change oil in the pump.
	Water sampling	Take water sample at the end of lateral lines and send it for analysis.
	Emitter delivery tests	Test specific emitters for discharge and pressure.
	Sprinkler parts	Replace nozzles annually and the other parts when needed.
	Pump	Replace the bearings and other worn out parts of the pump every five years.
2-10 years	Hydraulic valves	Replace the diaphragms in hydraulic valves every three years.
	Poly pipe and emitters	Replace the poly pipe and emitters every 7-10 years.

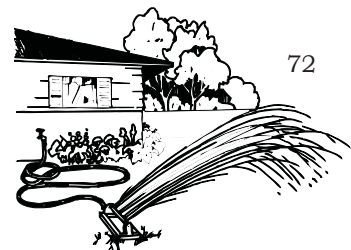

## Maintenance schedule for pumps

The following maintenance schedules, generally, apply to most pumps under average operating conditions.

### Monthly

Check the bearing temperature, as the bearing may run hot due to lack of lubrication or its excess.

### Quarterly

Drain lubricants in ring oil bearings and wash out the oil wells and bearing with kerosene.

### Half-yearly

Check the alignment of pump and driver, and add shims, if required. If misalignment occurs frequently, the entire piping system may have to be checked and necessary corrective actions may have to be taken. Replace gland packing.

### Yearly

Thoroughly inspect the unit once in a year. Remove bearings, clean and examine them for flaws. Remove the packing and examine wear and tear in the shaft sleeve or shaft. Disconnect coupling valves and check alignment. Inspect foot valve and check valves.

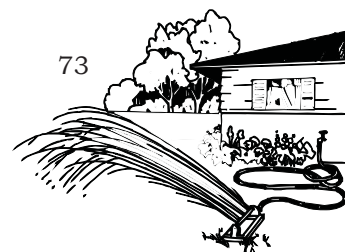
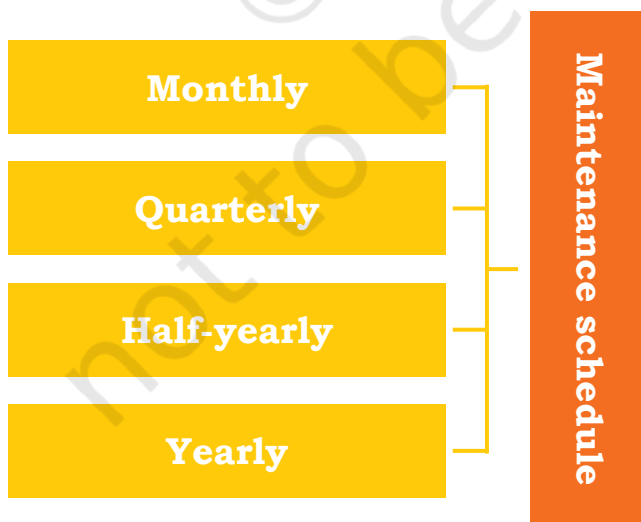

**Table 3.2: General pump glitches and their causes**

Glitches	Causes
No water delivered	<ul style="list-style-type: none"> <li>(i) Pump not primed</li> <li>(ii) Speed too low</li> <li>(iii) Discharge head too high</li> <li>(iv) Suction lift too high</li> <li>(v) Impeller or suction pipe completely plugged</li> <li>(vi) Wrong direction of rotation</li> <li>(vii) Air pocket in suction line</li> <li>(viii) Air leakage in suction line or stuffing box</li> <li>(ix) Insufficient net positive suction head available</li> </ul>
Not enough water delivered	<ul style="list-style-type: none"> <li>(i) Air leak in suction line or stuffing box</li> <li>(ii) Speed too low</li> <li>(iii) Discharge head higher than anticipated</li> <li>(iv) Suction lift too high</li> <li>(v) Impeller or suction pipe partially plugged</li> <li>(vi) Wrong direction of rotation</li> <li>(vii) Insufficient net positive suction head available</li> <li>(viii) Foot valve too small</li> <li>(ix) Insufficient submergence of suction inlet</li> <li>(x) Bearings worn out</li> </ul>
Not enough pressure developed	<ul style="list-style-type: none"> <li>(i) Speed too low</li> <li>(ii) Excessive amount of air or gas in liquid</li> <li>(iii) Wrong direction of rotation</li> <li>(iv) Viscosity of liquid higher than anticipated</li> <li>(v) Bearings worn out</li> <li>(vi) Impeller diameter too small</li> </ul>
Pump works for a while and then loses prime	<ul style="list-style-type: none"> <li>(i) Air leak in suction line or clogging</li> <li>(ii) Excess amount of air or gas in liquid</li> <li>(iii) Air pocket in suction line</li> <li>(iv) Water seal tube clogged</li> <li>(v) Suction lift too high</li> <li>(vi) Insufficient submergence of suction inlet</li> </ul>
Pump requires excessive power	<ul style="list-style-type: none"> <li>(i) Speed too high</li> <li>(ii) Head lower than anticipated, pumps too much water</li> <li>(iii) Specific gravity or viscosity too high</li> <li>(iv) Wrong direction of rotation</li> <li>(v) Misalignment</li> <li>(vi) Stuffing box too tight</li> <li>(vii) Rotating element rubbing or binding</li> <li>(viii) Bent shaft</li> <li>(ix) Bearings worn out</li> </ul>
Stuffing box leaks excessively	<ul style="list-style-type: none"> <li>(i) Packing is worn out and not adequately lubricated</li> <li>(ii) Packing not as per recommendations</li> <li>(iii) Shaft sleeve scored</li> <li>(iv) Bent shaft</li> </ul>



Pump noisy or vibrates

- (i) Suction lift too high
- (ii) Insufficient Net Positive Suction Head (NPSH) available
- (iii) Impeller or suction pipe partially plugged
- (iv) Misalignment
- (v) Foundation not rigid
- (vi) Lack of lubrication
- (vii) Bearings worn out
- (viii) Rotating element out of balance
- (ix) Bent shaft

## **Principles for maintenance of pipes, fittings and sprinkler heads**

The general principles regarding the maintenance of pipes, fittings and sprinkler heads are as follows.

### **Maintenance of pipes and fittings**

Pipes and fittings virtually require no maintenance but attention must be paid to the following.

- (i) Periodically, clean dirt or sand out of the groove in the coupler, in which the rubber sealing rings fit.
- (ii) Keep all nuts and bolts tight.
- (iii) Do not lay pipes on new damp concrete or on piles of fertiliser.
- (iv) Avoid trampling over the pipes.

Remove the end stop or end cap and flush the laterals or pipes for 1–2 minutes. Starting from the sub-main inlet, flush the first 4–5 laterals or pipes and proceed to the end. This will help in gaining higher velocity in the laterals and pipes for cleaning. Flush the sub-mains at the end of the irrigation process to remove debris.

### **Maintenance of sprinkler heads**

- (i) When moving the sprinkler lines, make sure that the sprinklers are not damaged or pushed into the soil.
- (ii) Do not apply oil, grease or any other lubricant on the sprinklers. They are water lubricated and using oil, grease or any other lubricant may stop them from working.
- (iii) Sprinklers, usually, have a sealed bearing and at the bottom of the bearing, there are washers.

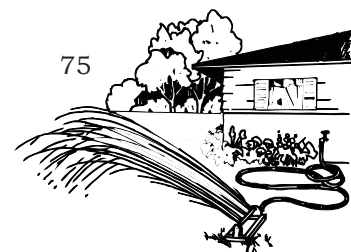

## NOTES

Usually, it is the washer that wears and tears and not the metal parts.

- (iv) Check the washers for wear and tear once a season or every six months, which is important in areas where the water is sandy. Replace the washers, if they are worn out.
- (v) After several operations, the swing arm spring may need tightening. This is done by pulling out the spring end at the top and rebending it. This will increase the spring tension.

### Backwashing

Backwashing is a process, in which the direction of the flow is reversed so that the water flows upwards through the sand bed. If backwashing is not done regularly, then impurities accumulate in the sand bed, thereby, reducing the efficiency of the filter. Besides, the system does not get water at the desired pressure.

The backwash operation is complete when clear water starts flowing out through the backwash valve. To resume the filtration process, perform the following.

- (i) Open the inlet valve.
- (ii) Close the bypass valve.
- (iii) Open the outlet valve.
- (iv) Close the backwash valve.

### Cleaning of filters

Clean the filters every 5–6 hours or at recommended timings based on the water quality analysis report. After cleaning the filters, operate the bypass valve of the header assembly to obtain the desired pressure in the system. It must be about  $1.5\text{--}2\text{ kg/cm}^2$  at the inlet of the filter and  $1\text{ kg/cm}^2$  at the inlet of the sub-mains.

### Maintenance of sprinklers

Check that each spray head covers the desired area of a field. The heads may have been knocked out of alignment by foot traffic, agriculture tools or machinery. To adjust this, move the nozzle of the sprinkler heads to redirect the spray and turn the spray reduction

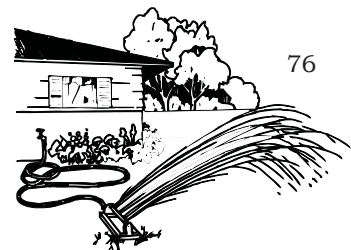

adjustment screw on the top of the nozzle. Replace the spray heads, if necessary. Sometimes, spray heads produce mist or fogging action rather than larger drops necessary for watering. This indicates that the water pressure is too strong. Adjust it at the main shut-off valve. Turn the valve clockwise, manually, until large drops of water are seen at the sprinkler heads. Some automatic valves have a special knob for adjustment called 'flow control', which adjusts the flow to minimise misting and fogging.

### Minor maintenance

- (i) Periodically clean the coupler to avoid dirt or sand accumulation in the groove, which may cause leakage from the rubber ring.
- (ii) Periodically, check the bolts and nuts, and keep them always tight.
- (iii) Maintain operating pressure in the system.
- (iv) Check the sprinkler heads at the end of each operating season and replace the damaged parts.
- (v) Blocked nozzles must never be cleaned with sharp metal parts. They may damage the distribution pattern of the nozzles. For cleaning the nozzles, use a wooden stick like a toothpick.
- (vi) Protect the sprinkler heads against striking with a hard surface or pressing into the soil.
- (vii) Ensure sufficient spring tension for smooth sprinkler rotation. Spring tension can be increased by pulling out the spring end at the top and bending it.
- (viii) Grease, oil or any other lubricant must not be used in the sprinkler nozzles as they are water lubricated.
- (ix) The sprinkler nozzles and rubber sealing must be stored in a dry place after cleaning and drying.
- (x) Protect the electrical motor from dust, dampness and rodents.
- (xi) Rotate the impeller of the pump by hand at the beginning of a new season before starting.
- (xii) Check the suction lift, air tightness, foot valve, gland packing and priming in case the pump is not discharging water.

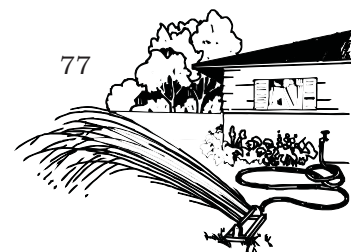

## Practical Exercises

### Activity 1

Visit an agricultural farm, where a sprinkler irrigation system is installed and study the following.

- (i) Are any sprinkler heads missing?
- (ii) Are any sprinkler heads broken?
- (iii) How many sprinkler heads are clogged?
- (iv) Are any sprinkler heads tilted or spray water too far?
- (v) Do the sprinkler heads spray water in a fine mist?

### Activity 2

Prepare a maintenance schedule for sprinkler irrigation system.

## Check Your Progress

### A. Multiple Choice Questions

1. \_\_\_\_\_ is a process in which the direction of water flow is reversed so that the water flows upwards through the sand bed.
 

(a) Backwashing	(b) Flushing
(c) Cleaning	(d) Pumping
2. Do not apply oil or any other lubricant on the sprinkler as it is lubricated with \_\_\_\_\_.
 

(a) oil	(b) grease
(c) water	(d) glycerol

### B. Fill in the Blanks

1. When installing sprinkler lines, we must make sure that the sprinklers are not \_\_\_\_\_ into the soil.
2. Do not apply oil, grease or any other lubricant to the sprinklers. They are \_\_\_\_\_ lubricated, and using oil, grease or any other lubricant may stop them from functioning.
3. Sprinklers, usually, have a sealed bearing and at the bottom of the bearing there are washers. Usually, it is the washer that wears and tears and not the \_\_\_\_\_ parts.
4. Maintained \_\_\_\_\_ will ensure maximum efficiency of an irrigation system by avoiding clogging of sprinkler heads.

### C. Subjective Questions

1. Write the steps for backwashing of sand filter.
2. Why is the operating pressure maintained in a sprinkler irrigation system?



## What have you learned ?

### After completing this Session, you will be able to:

- demonstrate the tasks associated with the maintenance of pipes and fittings.
- demonstrate the tasks associated with the maintenance of sprinkler heads.

## SESSION 3: MAINTENANCE OF DRIP IRRIGATION SYSTEM

An irrigation system requires minimal maintenance if it is planned and designed as recommended. It is advisable that all components must be checked as per the guidelines for installation of specific products. A maintenance plan and regular monitoring of the system ensures that minor problems do not turn into major ones.

The quality of water differs with its source. Higher rainfall in summer means that water sources are muddy due to increased content of silt and sand. Algae are more prevalent during warmer months, which increases the biomass that has to be filtered. The quality of water, usually, becomes poor because of lower water level as pumps tend to suck more dirt and there is little time for the silt and sand to settle out of the water. When the



*Fig. 3.4: Drip irrigation system*

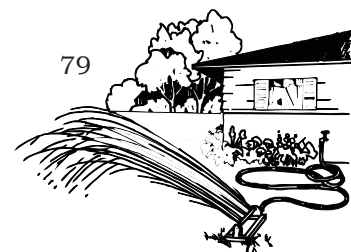



water quality is poor, filters must be flushed at regular intervals. It is essential to keep a record of lateral flushing, filter flushing and water quality.

In 'preventive maintenance', a procedure or group of procedures is adopted to prevent obstructions from plugging, clogging or blocking of drippers. In 'corrective maintenance', obstructions that cause dysfunction to the system are removed.

### **Maintenance of distribution network**

A drip irrigation system requires more attention and maintenance as compared to other irrigation systems. A drip irrigation system is vulnerable to over-pressurisation and clogging, both of which can drastically reduce the system's durability and performance.

For drip irrigation, turn on the system 20–30 minutes before inspection to allow enough time for emitter wetting patterns to show up. Check for leaks or clogged emitters from the valve to the end of the irrigation line. Check the placement of emitters near plants.

### **System flushing**

System flushing is the process of opening flush valves on the main line, sub-mains or laterals while under pressure. Flushing increases the water velocity inside the pipeline or dripper line, which scours and removes contaminants off the walls or from individual emitters. The pressure of the regulating valve is increased to achieve enhanced velocities, nevertheless, care must be taken not to exceed the burst pressure of the emitter line and take-off adapters. Recommended flushing velocities are as follows.

- (i) Main line: 1 metre per second
- (ii) Sub-mains: 1 metre per second
- (iii) Laterals: 0.5 metre per second

System flushing needs to be carried out at regular intervals. The frequency of flushing depends mainly on the water quality and weather. Table 3.3 indicates the starting point for flushing. However, individual site conditions influence the increase or decrease of flushing intervals.



*Fig. 3.5: Main or sub-main flushing*

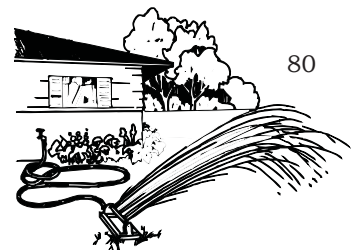

**Table 3.3: Flushing intervals**

Quality	Water source	Flushing interval
Good	Bore water with no presence of iron or magnesium	6 months
Average	Rivers, dams or lagoons that are slow flowing Wastewater discharged from industries after treatment	4 months
Poor	Rivers, creeks or canals found in hot climates with increased biological growth and no chemical treatment Faulty placement of the pumping point in the direction of wind with little or no sedimentation Untreated effluent water after sedimentation	Monthly
Very poor	Bore water having high iron or magnesium content	Fortnightly

## Types of filters and their maintenance

### Hydrocyclone filter

In hydrocyclone filter, water enters the hydrocyclone via a tangential inlet, which creates a spiral flow along the walls of the filter. The centrifugal force separates the waste and sand particles and pushes them towards the walls of the sand separator. Particles gravitate downwards into the sedimentation tank, while clean water moves upwards and exits through the top outlet. A hydrocyclone filter requires least maintenance as regards to cleaning. For cleaning, flush the chamber by opening the flush valve or cap or open the main valve. The filter becomes ineffective once the dirt collection chamber is full.

### Sand filter

Sand filter helps remove heavy organic and inorganic pollutants. Over a period, contaminants present in the water accumulate and clog the pore space of the sand bed, thereby, reducing filter efficiency.

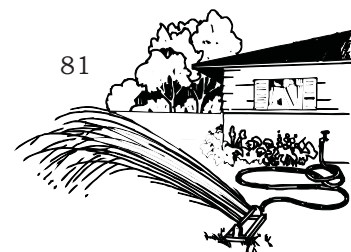

Backwashing is a process, in which the water flow direction is reversed and the sand bed is lifted and expanded, allowing it to release the collected dirt mainly from the top. Daily backwashing of sand filter is desired. The dirt is carried away through valve opening. The backwash flow needs to be adjusted with care as excess flow may lead to removal of sand from the filter, while insufficient flow will not clean the sand. The steps of backwash operation are as follows.

- (i) Open the backwash valve.
- (ii) Close the outlet valve.
- (iii) Open the bypass valve.
- (iv) Close the inlet valve.

Few installations come with semi-automatic and automatic backwash options, where opening and closing of the valve is done at the same time. The sand filter must also be cleaned regularly in the following manner.

- (i) Open the lid of the sand filter.
- (ii) Start the backflush operation.
- (iii) Put one hand inside the sand filter and stir the sand thoroughly.
- (iv) Allow all water along with dirt to flow through the main hole of the sand filter.
- (v) Close the lid for normal operation.

### Screen filter

Screen filters remove sand from water. Flushing at scheduled intervals is necessary for the maintenance of screen filters. It is recommended to flush the screen filter



Fig. 3.6: Backwashing



when the pressure drops more than  $0.5 \text{ kg/cm}^2$  (5 m at water head). The pressure difference can be observed by checking the inlet and outlet pressure by using a single three-way control valve at regular intervals. The process of cleaning the screen filter is simple. Flushing of a screen filter is done in the following manner.

- (i) Open the drain valve, thereby, allowing the water force to flush out dirt through the valve.
- (ii) Open the screen filter lid. Remove the screen and clean it under running water by rubbing it with a cloth or soft nylon brush.
- (iii) Protect the metal parts of the filter from scratches, acid, chlorine or fertiliser spillage, and apply oil paint immediately on the scratch to avoid corrosion.

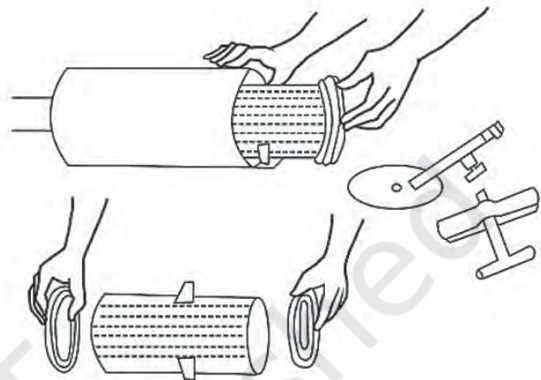

Fig. 3.7: Dismantling of screen filter

### Disc filter

A disc filter serves as a primary or secondary filter for water, which contains high amount of organic or inorganic matter. It consists of a stack of discs, each with a series of microscopic grooves. The dimension of the grooves determines the effective mesh size of the filter, which generally, ranges from 40 to 600 mesh. Disc filter requires less maintenance. Flushing of the disc filter is done either by opening the drain valve or by back flushing. The steps followed for cleaning the disc filter are as follows.

**Step 1:** Remove the filter element and loosen the disc set by extending the spine element.

**Step 2:** Now, remove the screen and clean it with pressurised clean water.

**Step 3:** Replace the worn out discs with clean ones.

**Step 4:** If the disc filter is to be cleaned with an acid or a chlorine solution, use the recommended concentration.

**Step 5:** Assemble the filter after cleaning.



Fig. 3.8: Cleaning of disc filter

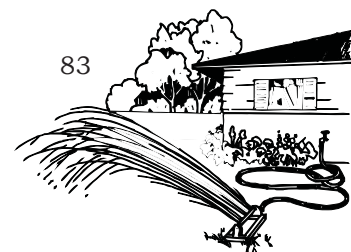

## Practical Exercise

### Activity

Obtain samples of used screen and disc filters, which need cleaning. Demonstrate the step-wise cleaning process for disc filter.

### Check Your Progress

#### A. Multiple Choice Questions

- Disc filters are designed for use as a primary or secondary filter when water contains high amount of \_\_\_\_\_.
  - organic matter
  - inorganic matter
  - both (a) and (b)
  - None of the above
- Disc filters are available in \_\_\_\_\_ mesh sizes.
  - 20–100
  - 40–600
  - 30–150
  - 40–200

#### B. Fill in the Blanks

- Drip irrigation system is vulnerable to over- \_\_\_\_\_ and \_\_\_\_\_, both of which can drastically reduce the system's durability and performance.
- System flushing is a procedure of opening flush \_\_\_\_\_ on the main line, sub-mains or laterals while under pressure.
- Flushing increases the water \_\_\_\_\_ inside the pipeline or dripper line, which removes contaminants off the walls or from individual emitters.
- The \_\_\_\_\_ of the regulating valve is increased to achieve enhanced appropriate velocities, nevertheless, care must be taken not to exceed the burst pressure of the emitter line and take-off adapters.

### What have you learned?

#### After completing this Session, you will be able to:

- describe the procedure of flushing for the maintenance of a drip irrigation system.
- demonstrate the procedure of cleaning filters in microirrigation system.
- explain the procedure for maintaining a distribution network in drip irrigation system.



## Microirrigation Technician Class-11 Unit-3 Session-1

### A. Fill in the Blanks

1. Each sprinkler delivers a \_\_\_\_\_ amount of water over a part of the entire zone.
2. The two main types of spray head installation are \_\_\_\_\_ and pop-ups.
3. Sprinklers are designed to \_\_\_\_\_ the watered areas.
4. Do not apply \_\_\_\_\_, grease or any other lubricant on to the sprinklers. They are water lubricated and using oil, grease or any other lubricant may stop them from working.

### B. Subjective Questions

1. Describe the operation of sprinklers.
2. Write a note on the maintenance of sprinklers.

## Microirrigation Technician Class-11 Unit-3 Session-2

### A. Multiple Choice Questions

1. \_\_\_\_\_ is a process in which the direction of water flow is reversed so that the water flows upwards through the sand bed.  
(a) Backwashing (b) Flushing  
(c) Cleaning (d) Pumping
2. Do not apply oil or any other lubricant on the sprinkler as it is lubricated with \_\_\_\_\_.  
(a) oil (b) grease  
(c) water (d) glycerol

### B. Fill in the Blanks

1. When installing sprinkler lines, we must make sure that the sprinklers are not \_\_\_\_\_ into the soil.
2. Do not apply oil, grease or any other lubricant to the sprinklers. They are \_\_\_\_\_ lubricated, and using oil, grease or any other lubricant may stop them from functioning.
3. Sprinklers, usually, have a sealed bearing and at the bottom of the bearing there are washers. Usually, it is the washer that wears and tears and not the \_\_\_\_\_ parts.
4. Maintained \_\_\_\_\_ will ensure maximum efficiency of an irrigation system by avoiding clogging of sprinkler heads.

### C. Subjective Questions

1. Write the steps for backwashing of sand filter.
2. Why is the operating pressure maintained in a sprinkler irrigation system?

## Microirrigation Technician Class-11 Unit-3 Session-3

### A. Multiple Choice Questions

1. Disc filters are designed for use as a primary or secondary filter when water contains high amount of \_\_\_\_\_.
  - (a) organic matter
  - (b) inorganic matter
  - (c) both (a) and (b)
  - (d) None of the above
2. Disc filters are available in \_\_\_\_\_ mesh sizes.
  - (a) 20–100
  - (b) 40–600
  - (c) 30–150
  - (d) 40–200

### B. Fill in the Blanks

1. Drip irrigation system is vulnerable to over- \_\_\_\_\_ and \_\_\_\_\_, both of which can drastically reduce the system's durability and performance.
2. System flushing is a procedure of opening flush \_\_\_\_\_ on the main line, sub-mains or laterals while under pressure.
3. Flushing increases the water \_\_\_\_\_ inside the pipeline or dripper line, which removes contaminants off the walls or from individual emitters.
4. The \_\_\_\_\_ of the regulating valve is increased to achieve enhanced appropriate velocities, nevertheless, care must be taken not to exceed the burst pressure of the emitter line and take-off adapters.

## ANSWER KEY

### UNIT 1: Introduction to Microirrigation

#### Session 1: Microirrigation Systems

##### A. Multiple Choice Questions

1. (a)
2. (b)
3. (b)
4. (c)

##### B. Fill in the Blanks

1. bubbler
2. water
3. drip
4. pressurised

##### C. State True or false

1. True
2. False
3. False

#### Session 2: Land Gradient and Suitability of Irrigation System

##### A. Multiple Choice Questions

1. (d)
2. (a)

##### B. Fill in the Blanks

1. sandy
2. winds
3. sediment
4. labour
5. land
6. drip
7. water

##### C. State True or false

1. False
2. False
3. True

#### Session 3: Design and Layout of Microirrigation System

##### A. Multiple Choice Questions

1. (a)
2. (c)
3. (a)



**B. Fill in the Blanks**

1. control
2. pressure
3. screen

**C. Match the Columns**

1. (d)      2. (c)      3. (e)      4. (a)      5. (b)

**D. 1. Write the full forms of the following**

- (i) psi = pounds per square inch
- (ii) lph = litres per hour
- (iii) lps = litres per second
- (iv) gpm = gallons per minute

**UNIT 2: Installation of Sprinkler Irrigation System**

Session 1: Installation of Components in Sprinkler Irrigation System

**A. Multiple Choice Questions**

1. (d)      2. (b)      3. (d)

**B. Fill in the Blanks**

1. Poly
2. Density
3. Linear
4. 63
5. 10

**C. State True or False**

1. True
2. False
3. True
4. True
5. False

Session 2: Tools and Material for Installation of Sprinkler Irrigation System

**A. Fill in the Blanks**

1. screwdriver
2. thermoplastic
3. Teflon tape
4. hacksaw

**B. State True or False**

1. False
2. False
3. True

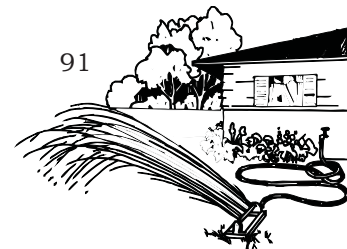

### Session 3: Classification and Suitability of Pumps

#### A. Fill in the Blanks

1. piston
2. electromechanical
3. electrical
4. shims
5. hydraulic

#### B. State True or false

1. False
2. True
3. True

### UNIT 3: Operation and Maintenance of Microirrigation System

#### Session 1: Operation and Monitoring of Sprinkler Irrigation System

#### A. Fill in the Blanks

1. metered
2. risers
3. overlap
4. oil

#### Session 2: Maintenance of Sprinkler Irrigation System

#### A. Multiple Choice Questions

1. (a)
2. (c)

#### B. Fill in the Blanks

1. pushed
2. water
3. metal
4. filters

#### Session 3 Maintenance of Drip Irrigation System

#### A Multiple Choice Questions

1. (c)
2. (b)

#### B. Fill in the Blanks

1. pressurisation, clogging
2. valve
3. velocity
4. pressure



© NCERT  
not to be republished

© NCERT  
not to be republished

## GLOSSARY

**Aerobic rice cultivation:** *It is a way of growing rice in non-submerged unpuddled condition in aerated soils.*

**Agriculture:** *The art and science of cultivating crops and rearing domestic animals.*

**Aquifer:** *It is an underground layer of water-bearing permeable rock, rock fractures or unconsolidated material.*

**Back flush:** *The process of flowing pressurised water backwards through a filter to remove trapped debris and restore the filtration system for ongoing use.*

**Back pressure:** *An increase of pressure in the downstream piping system above the supply pressure at a point of consideration, which can cause a reversal of the normal direction of flow.*

**Backwash:** *A process in which the direction of the flow is reversed so that the water flows upwards through the sand bed.*

**Basin irrigation:** *It is a type of surface irrigation method, in which the field is divided into a number of checks or basins.*

**Border irrigation:** *In this type of surface irrigation, the field is divided into a number of borders, which are long and uniformly graded strips of land separated by earth bunds.*

**Cavitation:** *It is the formation of bubbles or cavities in a liquid, developed in areas of relatively low pressure around an impeller. The imploding of these bubbles triggers intense shockwaves inside the pump, causing significant damage to the impeller or pump housing.*

**Centre pivot:** *An automated irrigation system, consisting of a sprinkler line, rotating about a pivot point at one end and supported by a number of self-propelled towers.*

**Check valve:** *It is an in-line valve that allows water to flow in one direction only.*

**Clogging:** *It is the blocking of drip emitters by silt or other suspended solid matter.*

**Coarse grained soil:** *Soil containing more than 50 per cent minerals by weight and the size of soil particles is more than 75 micron.*

**Contour lines:** *These lines are found on a topography map. A contour line is an imaginary line that is obtained by joining the points of constant elevation on the surface of the ground.*

**Controller:** *It is an automatic timing device that sends an electric signal for automatic valves to open or close, according to a set irrigation schedule.*

**Drip irrigation:** *A type of microirrigation system that has the potential to save water and nutrients by allowing water to drip slowly to the roots of plants.*

**Drip lateral:** *A water delivery pipeline or Low Linear Density Polyethylene (LLDPE) pipe that supplies water to the emitters from the main lines or sub-mains.*

**Elbow:** A small pipe that is used to make a 90 or 45 degree turn in a water line.

**Electrical solenoid valve:** An electro-mechanical device, in which the solenoid uses electric current to generate a magnetic field, thereby, operating a mechanism that regulates the opening of water in a valve.

**Emitter:** An irrigation device moulded from plastic and designed to deliver precise amounts of water to particular areas.

**Evaporation:** The process by which water changes into vapour.

**Evapotranspiration:** The water lost from the soil and plants through the processes of evaporation and transpiration in a combined form.

**Fertigation:** The application of fertilisers, plant nutrients or amendments through an irrigation system.

**Fertiliser:** An organic or inorganic material, either natural or synthetic, used to supply elements, such as nitrogen, phosphate, potash, etc., which is essential for plant growth.

**Field capacity:** The depth of water retained in the soil after draining the gravitational water. This stage is, normally, reached after 1–3 days after irrigation or rain. It is expressed as the depth of water in inch or foot. It is also called 'field moisture capacity'.

**Flood irrigation:** A surface irrigation method, in which a field is essentially flooded with water that is allowed to soak into the soil to irrigate the plants.

**Flow control valve:** A device that controls or regulates the flow or pressure of a liquid.

**Flow rate:** The rate of flow or volume per unit period of time.

**Flushing:** It involves opening the ends of a pipe system and using an appropriate velocity to flush sediment and algae built up in sub-mains or tubes.

**Flush valve:** A fitting that empties water lines upon shutdown.

**Friction loss:** It is a drop in pressure as water moves through tubing due to friction in a pipeline.

**Furrow irrigation:** An irrigation method where water flows down in small trenches running between crops.

**Gravity flow:** A flow of water drawn through a conduit under the force of gravity.

**Gravity irrigation:** An irrigation method, in which water pressure is generated by elevation.

**Groundwater:** It is the water below the Earth's surface. Water stored in an aquifer is also called groundwater.

**Hazard:** The danger that an injury will occur with the use of an equipment, chemical or pesticide, etc.

**Horsepower:** The power of an engine is measured in terms of horsepower. It is equal to 550 foot-pound per second (about 745.7 watts).

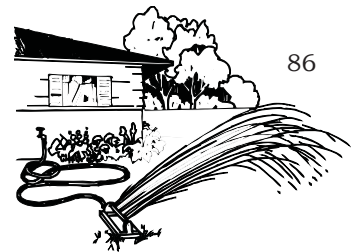

**Impeller:** A rotating component equipped with vanes or blades used in turbo machinery, such as centrifugal pump.

**Infiltration:** The process of water movement through the soil surface into the soil matrix.

**Infiltration rate:** The velocity or speed at which water permeates into the soil. It is, usually, measured by the depth (in mm) of water layer that enters the soil in one hour.

**Irrigation frequency:** It is the measure of the number of irrigation applied per unit time.

**Irrigation interval:** The average interval between the commencement of successive irrigations in a field or an area.

**Irrigation schedule:** The schedule that decides when to irrigate a land and how much water to apply as per the measurement or estimate of soil moisture or crop water used by a plant.

**Irrigation system:** It includes the water source, water distribution network, control components and irrigation equipment.

**Laterals or lateral pipes:** Pipes used for conveying water from sub-main lines in case of drip irrigation, while in sprinkler irrigation, sprinklers are mounted on these pipes.

**Leaching:** Loss of water soluble plant nutrients from the soil.

**Main line:** A pipe that supplies water from the point of connection to the control valves.

**Mesh filtration:** A process that uses mesh filters or mesh screens to filter water.

**Microirrigation:** An irrigation system with small, closely spaced outlets used to apply small amounts of water at low pressure.

**Mist irrigation:** An irrigation method, in which water is applied in the form of small droplets.

**Mister:** An emitter designed to 'atomise' water into fog or heavy mist.

**Net Positive Suction Head:** It is defined as the difference between the suction head and liquid vapour head.

**Orifices:** A submerged opening with a closed perimeter through which water flows.

**Perennial crops:** Plants having a life cycle of more than two years.

**Peri-urban agriculture:** Agriculture done in places on fringes of urban areas.

**pH:** Negative logarithms of  $H^+$  ion concentration of a given solution.

**Pitting corrosion:** A type of corrosion that occurs in material having protective films.

**Pre-plant irrigation:** Pre-plant irrigation supplies moisture to the root zone of a plant prior to planting.

**Pressure gauge:** A device used for measuring the pressure of water.

**Pressure regulator:** A device used to reduce the incoming water pressure, which can be high for a drip irrigation system.

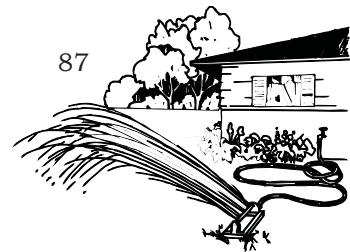

**Pressurised irrigation:** An irrigation system, in which water is conveyed to and distributed over a farmland through a network of pressurised pipes.

**Priming:** A process in which the impeller of a centrifugal pump is fully submerged in liquid without any air trapped inside.

**Pump:** A device that discharges a fluid by increasing the pressure.

**Root zone:** The depth of soil up to which the plant roots readily penetrate, and in which predominant root activity takes place.

**Run-off:** It is the downward movement of rainwater or surface water under gravity in channels ranging from small rills to large rivers.

**Screen filter:** A filter utilising fine mesh screens to remove particles from flowing water.

**Sediment:** Solid fragments of inorganic or organic material that come from the weathering of rocks and are carried and deposited by wind, water or ice.

**Shim:** A thin packing strip or washer often used with a number of similar washers or strips to adjust a clearance for gear.

**Shut-off valve:** A device used to shut off the water supply.

**Soil crusting:** A thin layer of dense and tough material formed when clay particles are splattered across the soil surface as rainwater spreads. The clay is filtered on to the surface and forms a hard crust.

**Soil texture:** The percentage share of sand, silt and clay in soil.

**Solenoid:** Coil of wire used as an electromagnet.

**Solenoid valve:** An electro-mechanical device, in which the solenoid uses electric current to generate a magnetic field and operate a mechanism that regulates liquid flow in a valve.

**Spout:** A tube-shaped opening that allows liquids to be poured out of a container.

**Sprinkler irrigation:** An irrigation method, in which water is sprayed or sprinkled in the air, which falls on the ground surface.

**Sub-irrigation:** The application of irrigation water below the ground surface either by raising the water table within or near the root zone or by using a buried perforated or porous pipe system that discharges water directly into the root zone.

**Sub-mains:** Pipes that are laid on both sides of the main line.

**Sub-surface drip irrigation:** A drip irrigation technique, in which the application of water is done below the soil surface through emitters.

**Surface irrigation:** The application of water on land by surface flow.

**Surface sealing:** The permanent covering of the soil surface with an impermeable material. The drying of surface sealing results in soil crusting, which may hinder the germination of seeds.

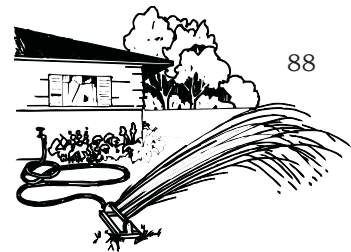



**Surface soil:** *The upper part of the soil mass about 10–20 cm in thickness.*

**Surface water:** *It refers to an open water body like river, stream or lake.*

**Sustainable agriculture:** *A systematic approach to agriculture that focuses on ensuring long-term productivity through the use of natural resources for meeting food and fibre needs.*

**Timer:** *An automatic timing device that sends an electric signal to open or close valves by a set irrigation schedule.*

**Topography:** *The study of the shape and features of land surfaces. It refers to the slope of the ground and how much uneven or levelled it is.*

**Topographic map:** *A map that contains information about the topography of an area. It includes contours lines, location of natural features like gullies, ditches and location of man-made features, such as buildings, roads, culverts, bridges, etc. These are needed for detailed planning of irrigation method.*

**Tortuous:** *It means full of twists and turns.*

**Transplanting:** *The process of shifting a plant from one place to another.*

**Valve:** *A device that controls the flow of liquid within a system.*

**Vane:** *A broad blade of a machine or device attached to a rotating axis or wheel which pushes wind or water.*

**Vortexes:** *A circular, spiral, or helical motion in a fluid.*

**Water application efficiency:** *It is expressed as the percentage of the total volume of water delivered to a field that is stored in the root zone of plants to meet the crop evapotranspiration needs.*

**Water hammer:** *It is a pressure surge caused when water in motion is forced to stop or change direction.*

